

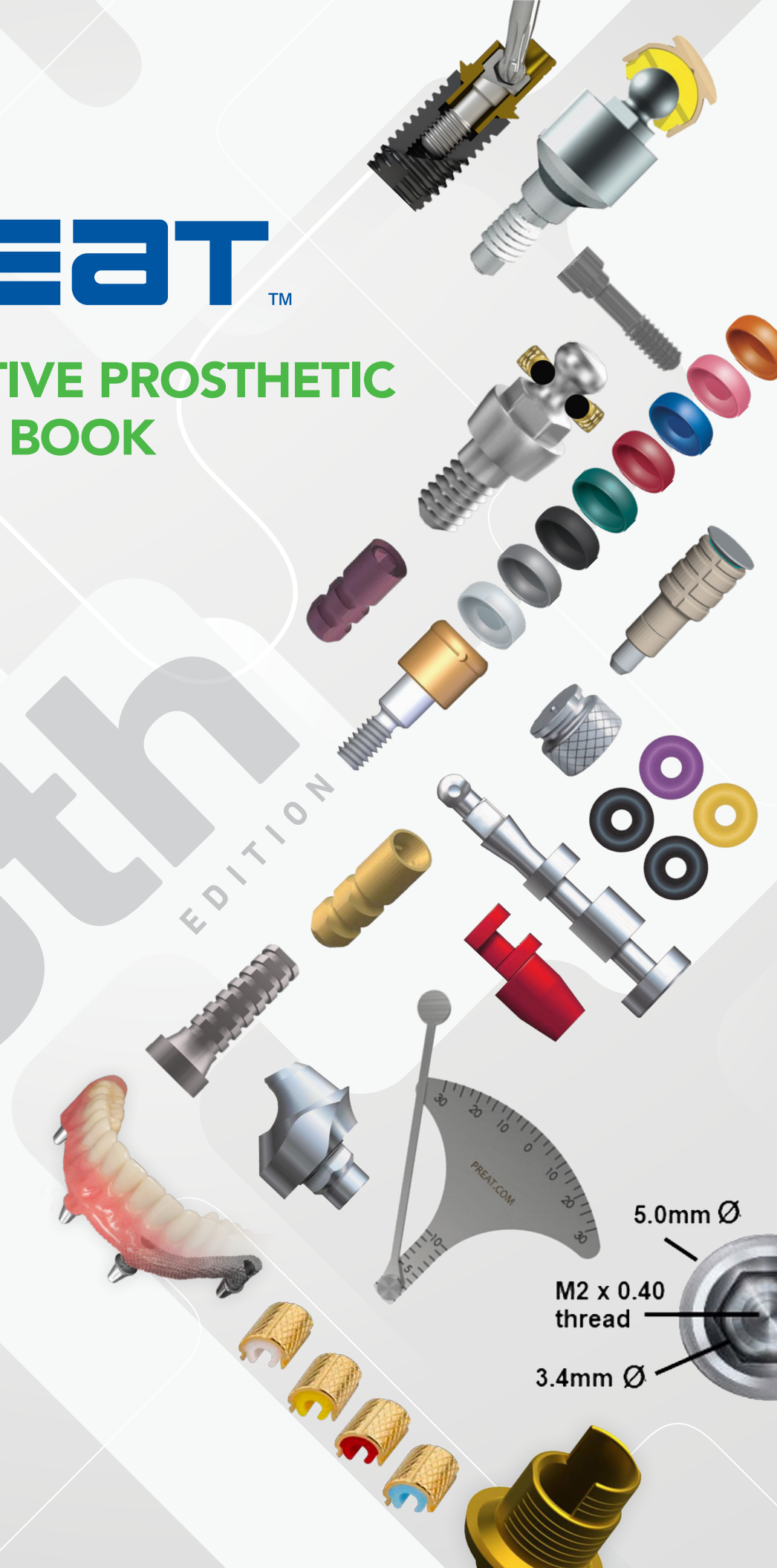

PREAT™

RESTORATIVE PROSTHETIC PRODUCT BOOK

10th EDITION



5.0mm Ø

M2 x 0.40
thread

3.4mm Ø

Preat.com
800-232-7732

CONTENTS

ATTACHMENTS

OVERDENTURE BARS

11	Hader Bar
15	Ackermann MD & BL
17	Universal Plunger Loc
17	Dolder Bar
37	LOCATOR® Bar
69	Clix
72	Sagix
83	Ceka and Ceka Revax
216	PRISM SLM Bars

OVERDENTURE STUDS

18	O-Ring Size Chart
19	O-Rings / OSO
21	Sphero Flex Post System
22	Sphero Reconstruction Kits
23	Preci Ball
24	ZAAG
26	Zest Anchor
27	Magnets
36	LOCATOR®
69	Clix
83	Ceka and Ceka Revax

IMPLANT ABUTMENTS/ATTACHMENTS

27	Magnets
29	Clix
33	O-Ring Abutment
36	LOCATOR® Abutment
50	LOCATOR R-Tx®
57	Lodi NDI Implant System
60	LOCATOR F-Tx®
65	Sphero Flex / Sphero Block
67	Internal Hex Tube and Screw
90	Internal Hex Pin Screw
186	Drivers and Implant Components

**EXTRACORONAL ATTACHMENTS FOR
REMOVABLE PARTIAL DENTURES**

69	Sphero Retrofit Kit
69	Clix
72	Sagix
76	Vertex
77	American Mini (Mini Dalbo)
77	Preci-52 (ASC52)
78	O-Ring Distal Extension Attachment
78	Mays Unilateral
78	Universal IC Attachment
78	DSE Hinge
79	Ceka and Ceka Revax
185	CSA - Castable Spherical Attachment

IMPLANT WIZARD LINE	120	Bidra Conversion Polishing Caps
	188	Cuff Height & Angulation Tool Set
	185	Implant Buddy
	137	Mobile App for Implant Identification

CROWN & BRIDGE SPECIALTY	87	Splintastik
	87	Double Mandrel BPD
	88	Preci Post
	88	Pozi Pins
	89	Fiberglass & Brass Pencils
	89	Preci Profile
	89	FR Attachment
	90	Internal Hex Pin Screw

FIBER TECHNOLOGY	93	TriLor High Performance Polymer
	95	eFiber
	96	Perma Mesh
	97	Everstick

CLINICAL SPECIALTY	95	eFiber
	98	Chairside Attachment Pickup Material
	98	Denture Removal Tool
	99	Implantlink Temporary Cement
	98	Perma Block
	98	Wagner Impression Tray

REMOVABLE PROSTHETIC SPECIALTY

100	Perma Ret
100	Denture Stippling Mandrel
100	Gingivamoll
101	Pro Blue NTR Polishing Compound 150g
101	Goats Hair Brushes and Wheels
102	Silicone Cutters/Polishers
103	Ceka Sol

DYNAMIC ABUTMENT SOLUTION

107	Drivers
107	Scan Body(s)
112	3i Certain
114	3i Osseotite NP
115	Astra EV
113	Astra
117	BioHorizons
115	Branemark NP
110	Branemark RP
114	Camlog
116	Hiossen
117	Keystone Prima Connex
116	Megagen
114	Multi-Unit
115	Neoss
109	Nobel Active
108	Nobel Tri-Lobe
111	Straumann
107	Zimmer

CAD-CAM SOLUTIONS

104 Attachment Options

CONTENTS
IMPLANTS

IMPLANTS

119 Multi-Unit Components

121 3i

128 ACE Surgical

129 Ankylos

131 Astra

136 BioHorizons

136 Bio-Lok

136 Blue Sky Bio

159 Branemark

138 Camlog

144 Glidewell Laboratories

145 Hiossen

148 Hi-Tec

148 Imtec

148 IMZ

148 Implant Direct

148 Lifecore

149 Megagen

151 MIS

151	Neoss
152	Nobel Biocare
169	Southern
169	Sterngold
170	Straumann
178	Zimmer
186	Implant Drivers and Tools

CONTENTS

INFORMATION

105	Alloy Chart
118	Dynamic Abutment Solutions Workflow
192	Implant Compatibility Chart
196	Implant Driver Size
198	Implant Identification
196	Implant Screw Size
196	Implant Screw Torque Values
41	LOCATOR® Dimensional Specifications & Pivoting Function
41	LOCATOR® Retention Insert Guide
28	Navigating the Overdenture Stud Maze
18	O-Ring Size Chart
137	Preat App for Implant Identification
68	Removable Partial Denture Attachments
93	TriLor Material Comparison
13	Why Hader Bar for Bar Overdentures

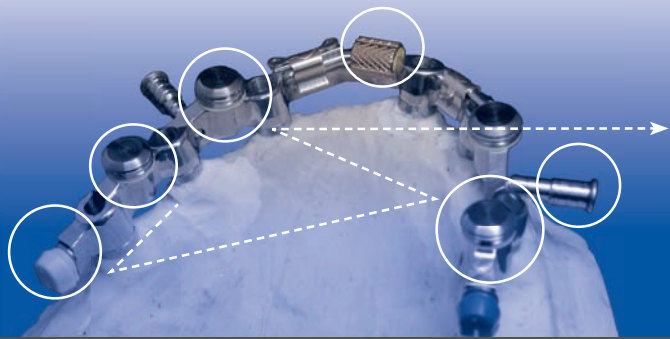

LET PREAT MAKE BARS SIMPLE!

OVERDENTURE BAR ATTACHMENTS

DIRECT RETAINERS



Hader Bar Attachment
4mm↓ x 3mm



4 Retention clips provide rotational movement on the bar

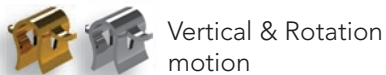

Vertical & Rotation motion



Dolder Bar Attachment
4mm↓ x 3.5mm

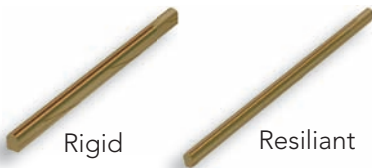

ON TOP OF BAR



LOCATOR® Attachment
4mm↓ x 5.5mm

8 Retention Inserts
Attachment can hinge, have vertical and rotational movement



Clix Attachment
4mm↓ x 4mm

Attachment can hinge, have vertical and rotational movement



Ceka Attachment
3mm↓ x 3mm

System can hinge, have vertical and rotational movement

OFFSET ATTACHMENTS



Universal Plunger Loc
2.5mm↓ x 4mm
Can be rigid or resilient

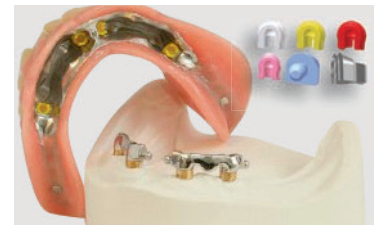

Sagix Attachment
3.1mm↓ x 3mm
Attachment can hinge and rotate



Vertex Attachment
3.5mm↓ x 3mm
Allows vertical movement

OVERDENTURE BARS

NUMBER	PRODUCT NAME	PRICE
<p>Hader Bar: the most popular and versatile bar attachment in the world. Low profile, secure retention options, and simple servicing! 3.5mm tall 4.20mm Ø housing</p>		
0101701	Hader Bar Kit <i>2 castable bars, 6 yellow riders, 6 green processing, 1 insertion tool</i>	92.00
0101731	Hader Plastic-Wax Bar Kit <i>2 plastic-wax castable bars, 6 yellow riders, 6 green processing, 1 insertion tool</i>	92.00
0101750	Hader Combo Kit <i>1 castable bar, 2 metal housings, 2 yellow riders, 2 green processing, 1 insertion tool</i>	84.00
0101741	Hader Combo Kit <i>1 castable bar, 2 metal housings, 2 yellow riders, 2 green processing, and 1 insertion tool</i>	84.00
0101742	Hader Alignment Combo Kit <i>1 castable bar, 2 alignment metal housings, 2 yellow riders, 2 green processing, 1 insertion tool</i>	84.00
0101745	Hader Servicing Kit <i>Delrin Analog, 2 metal housings, 2 yellow riders, 2 green processing, 1 insertion tool</i>	88.00
0101746	Hader Bar Alignment Servicing Kit <i>1 Delrin Analog, 2 alignment housing, 2 yellow riders, 2 green processing, 1 insertion tool</i>	88.00
0101120	Hader PlasticWax Bar (4-Pack)	36.00
0106905	8 Degree Tapered PlasticWax Bar (4-Pack)	36.00
0101164	Round Bar Plastic (4-Pack)	54.00
0101704-6	Hader Plastic Bar Patterns (Standard) (6-Pack)	54.00
0101704-50	Hader Plastic Bar Patterns (Standard) (50-Pack)	350.00
0101709-6	Hader Plastic Bar Pattern (Short) (6-Pack)	54.00



Hader Bar



Hader Bar



Hader Bar



0101701



0101731



0101742



0101745



0101704

What's New with HADER Bars...

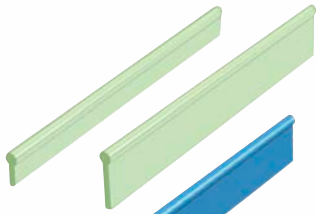

Bar Patterns

Available in Standard and Short heights

Plastic-wax is ideal for fast set investment

Aluminum Analog Bar Delrin Analog Bar

Two different analog bars for relines, repairs, and making new prostheses



Hader Bar Mandrel

to assure parallelism between multiple bar segments



Processing Spacer

The processing spacer will prevent the over extension of acrylic which inhibits flexation of the female rider

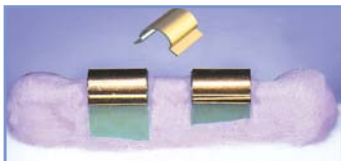

Processing model with green processing spacers & thin metal housings

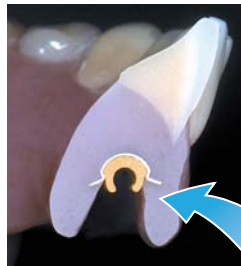

Incorrect - Female clip cannot flex over the bar

Kits

The Combo Kit

everything needed for one bar case

Includes:

- 1 Plastic Bar Pattern
- 2 Female Riders
- 2 Metal Housings (either style)
- 2 Processing Spacers

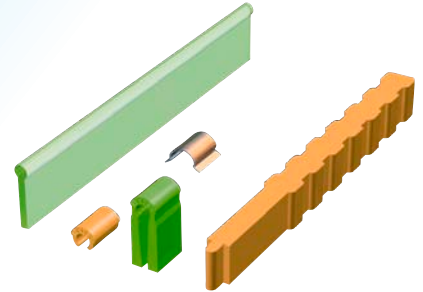

Hader Bar Servicing Kit

Ideal for relines, rebases, repairs, or fabricating a new overdenture on existing bars or CAD-CAM bars

Includes:

- 1 Delrin Analog Bar
- 2 Female Riders
- 2 Metal Housings (either style)
- 2 Processing Spacers

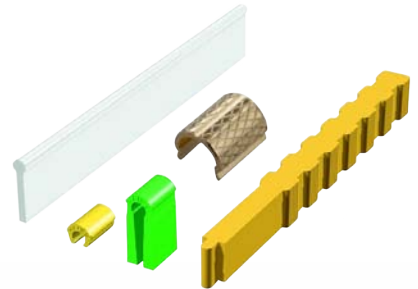

New Alignment Housings

Traditional Housings



Easy and accurate alignment of riders and housings with space saving options.

Female Riders

4 retentions of female riders

- **Yellow**-standard
- **White**-decreased
- **Red**-increased
- **Blue**-for worn bars



Metal Clips available in gold and stainless steel

Ackermann gold and stainless and C118 gold and stainless

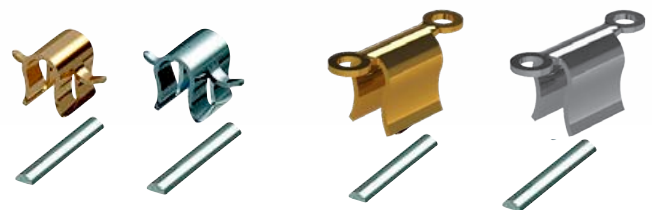

WHY HADER BARS ARE THE BEST OPTION FOR BAR OVERDENTURES

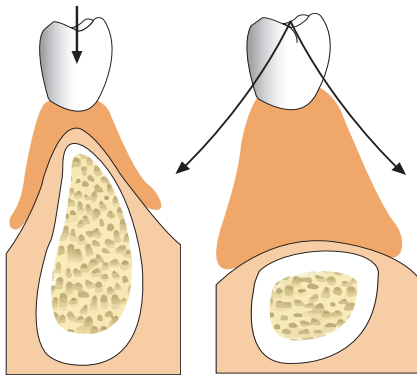

Indications:

- In the maxillae, the bone quality and quantity often dictates the use of a bar to protect the implants in weaker bone via splinting.
- In the resorbed mandible, the atrophied ridge can not be engaged by the denture flange and therefore does not provide prosthesis stability.
- Extremely divergent implants are easier to accommodate with a bar overdenture.

Advantages of the Hader Bar:

• Flexibility in Prostheses Function:

- o Metal Ackermann clips provide both vertical and rotational movement, ideal for 2 abutments bar with a single straight section and for protecting abutments.
- o Plastic Hader clips provide rotational movement. Ideal for restorations utilizing multiple bar sections and/or for rigid/fully abutment supported prostheses.

• Space Saving:

- o Total vertical height of bar, 2.5mm.
- o Total vertical of attachments, 1.5mm.
- o Total width of attachment, 4.2mm.

• Easy to Service:

- o 4 retentions of plastic clips to provide patient specific retention
 - Replacing a Hader clip can be done in less than 30 seconds
- o 2 designs and 2 alloys of metal Ackermann clips

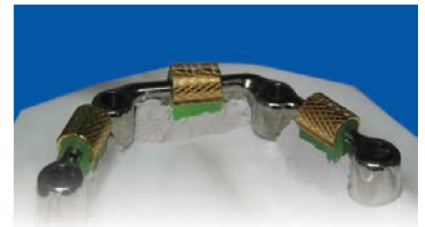
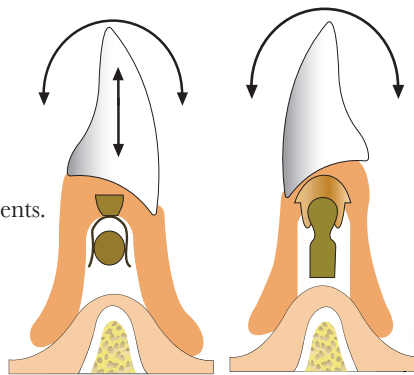

Images courtesy of PREAT Corporation Technical Team

OVERDENTURE BARS



0101770



0101765



0101705



0101703-6

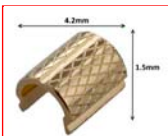

0101720-6

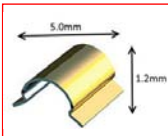

0101710-6



Hader Bar



0101753

NUMBER	PRODUCT NAME	PRICE
0101709-50	Hader Plastic Bar Pattern (Short) (50-Pack)	350.00
0101770	Hader Paralleling Mandrel	58.00
0101765	Hader White Delrin Analog (2-Pack)	36.00
0101705	Hader Insertion Tool	11.00
0101703-6	Hader Green Processing Spacers (6-Pack)	36.00
0101703-50	Hader Green Processing Spacers (50-Pack)	225.00
0101720-6	Hader Alignment Housing (6-Pack)	72.00
0101720-24	Hader Alignment Housing (24-Pack)	240.00
0101720-50	Hader Alignment Housing (50-Pack)	400.00
0101710-6	Hader Metal Housings (6-Pack)	72.00
0101710-24	Hader Metal Housings (24-Pack)	240.00
0101710-50	Hader Metal Housings (50-Pack)	400.00
0101753-6	Hader White Riders - Reduced (6-Pack)	36.00
0101753-24	Hader White Riders - Reduced (24-Pack)	120.00
0101753-50	Hader White Riders - Reduced (50-Pack)	200.00
0101752-6	Hader Yellow Riders - Standard (6-Pack)	36.00
0101752-24	Hader Yellow Riders - Standard (24-Pack)	120.00
0101752-50	Hader Yellow Riders - Standard (50-Pack)	200.00
0101754-6	Hader Red Riders - Increased (6-Pack)	36.00
0101754-24	Hader Red Riders - Increased (24-Pack)	120.00

OVERDENTURE BARS

NUMBER	PRODUCT NAME	PRICE
0101754-50	Hader Red Riders - Increased (50-Pack)	200.00
0101760-6	Hader Blue Riders - Worn Bars (6-Pack)	36.00
0101760-24	Hader Blue Riders - Worn Bars (24-Pack)	120.00
0101760-50	Hader Blue Riders - Worn Bars (50-Pack)	200.00



0101752



0101754



0101760

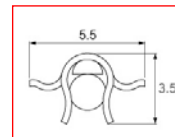

0102108

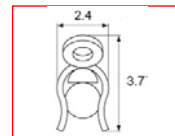

0102118



0102119



0102124



Ackermann

Ackermann Clips: Metal Riders provide both rotational and vertical movement with a choice of two styles of acrylic retentions

0102108	Ackermann BL Clip SS	32.00
0102108-6	Ackermann BL Clip SS (6-Pack)	162.00
0102118	Ackermann MD Clip SS	32.00
0102118-6	Ackermann MD Clip SS (6-Pack)	162.00
0102119	Ackermann MD Clip GOLD	44.00
0102119-6	Ackermann MD Clip GOLD (6-Pack)	228.00
0102124	Ackermann BL Clip GOLD	44.00
0102124-6	Ackermann BL Clip GOLD (6-Pack)	228.00

UNIVERSAL PLUNGER LOC ATTACHMENT



Titanium locking pin attachment designed for resilient or rigid retention on implant overdenture bars.

- **Biocompatible Titanium**
- **Simple to Service**
- **Standard Techniques**



One universal size may be adjusted from
7.5mm to 4mm in length.

The 1.5mm diameter plunger is compatible with the
Lew Passive and Swiss Loc NG attachment systems.

OVERDENTURE BARS

NUMBER	PRODUCT NAME	PRICE
--------	--------------	-------

Plunger Loc: titanium locking plunger for Overdenture Bars. May be rigid or resilient. 7.5mm long, may be cut to 6, 5, or 4mm. 1.5mm Ø plunger Plunger Diameter compatible with Swiss-Loc & Lew Passive

01776000	Universal Plunger Loc Attachment	68.00
01776005	Universal Plunger Loc Processing Jig	21.00
01776010	Universal Plunger Loc Male Only	30.00
01776015	Universal Plunger Loc Twist Drill	12.00

Dolder Bar: Rigid or Resilient Direct Retainer Precision Bar Overdenture Attachment System. Large U bar=2.2mm Ø ; Small Pear bar = 1.6mm Ø

0101112	Dolder Bar Standard Rigid Gold Male 50mm	390.00
0101113	Dolder Bar Standard Rigid Pallax Male 50mm	195.00
0101161	Dolder Bar Standard (Rigid) Plastic Bar (4-Pack)	56.00
0101165	Dolder Bar Standard (Resilient) Plastic Bar (4-Pack)	56.00
0101106	Dolder Bar Standard Gold Female 50mm	310.00
0101109	Dolder Bar Standard Pallax Female 50mm	160.00
0101110	Dolder Bar Mandrel Standard	60.00
0101104	Dolder Bar Mini Resil. Gold Male 50mm	270.00
0101105	Dolder Bar Mini Resil. Pallax Male 50mm	135.00
0101163	Dolder Bar Mini (Resilient) Plastic Bar (4-Pack)	56.00
0101107	Dolder Bar Mini Gold Female 50mm	225.00
0101111	Dolder Bar Mini Pallax Female 50mm	140.00
010110	Dolder Bar Mandrel Mini	60.00



Plunger Loc

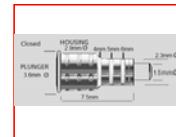

Plunger Loc



1776000



Plunger Loc



Dolder Bar



0101106



0101109



0101165



To determine the correct size O-ring needed, measure the retention zone (red line) – or the area on the male post where the O-ring seats. Select the O-ring from the size chart with the closest matching internal diameter to assure proper fit. The O-ring Combo pack is a great option as well.

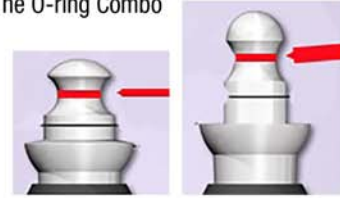

O-RING REPLACEMENT SIZE CHART

		Internal Diameter (ID)	Outside Diameter (OD)	
	SIZING	mm	mm	PRICE
Black #2 Pkg 12	Micro	1.00 mm	3.60 mm	\$27.00
Black #2M Pkg 6	1.8 Mini	1.20 mm	3.60 mm	\$27.00
White #3 Pkg 12	Standard	1.40 mm	4.50 mm	\$23.00
Black #3 Pkg 12	Standard	1.40 mm	4.50 mm	\$27.00
Black #4 Pkg 6	Large	2.00 mm	5.20 mm	\$27.00
Black #5 Pkg 6	Extra Large	2.40 mm	6.25 mm	\$30.00
Combo Pack 2 of each ring (10 total)	Micro (2) Mini Implant (2) Standard (2) Large (2) Extra large (2)	2 of each size (Black)		\$48.00
Black #2 Pkg 12	Micro (2) Mini Implant (2) Standard (2) Large (2) Extra large (2) Insertion Tool	2 of each size (Black) Insertion Tool		\$100.00
	Metal Retainer Ring #2 (fits both #2 and #2M) Metal Retainer Ring #3 (each)			\$18.00
	Metal Retainer Rings #4 (each)			\$27.00
	Metal Retainer Rings #5 (each)			\$27.00

OVERDENTURE STUD

NUMBER	PRODUCT NAME	PRICE
<p>O-Ring Attachment: features simple techniques, low cost, versatility, and is the most resilient option to protect weaker abutments 3.20mm tall 3.00mm Ø tooth surface 4.50mm Ø housing</p>		
1500200	O-Ring Black O-Ring Combo Pack (10-Pack) <i>2 of each size of O-Ring (10 total): #2, #2M, #3, #4, and #5</i>	48.00
4008049	O-Ring Insertion Tool	62.00
1500202	O-Ring Servicing Kit <i>O-Ring Combo pack plus O-Ring Insertion Tool</i>	100.00
1500610	O-Ring Mini Implant Servicing Kit <i>1 impression coping, 1 model analog, 1 MH-2 closed housing, 1 yellow processing O-ring, 2 black O-rings, 1 purple extra strong O-ring</i>	62.50
1500632	O-Ring Overdenture Complete #2 w/ housing <i>1 Castable Male, 3 black final rings, 1 yellow processing ring, 1 metal retainer ring, 1 processing analog</i>	48.00
1500634	O-Ring Overdenture Attachment #2 <i>1 Castable Male, 3 black final rings, 1 yellow processing ring</i>	40.00
1500630	O-Ring Castable Male #2 Micro	10.00
1500602	O-Ring Metal Retainer #2 & 2M	18.00
1500501	O-Ring Closed Metal Housing MH-1	24.00
1500601	O-Ring Closed Metal Housing #2 MH-2	24.00
1500608	O-Ring Purple Rings #2 MH-2 Extra Strong (12-Pack)	27.00
1500605	O-Ring Yellow Processing #2 Micro (12-Pack)	26.00
1500603	O-Ring Black Rings #2 Micro (12-Pack)	27.00
1500212	O-Ring Mini Implant Impression Copings	20.00
1500606	O-Ring Overdenture Analog #2 Micro	16.00



O-Ring



1500200



4008049



1500610



1500602



1500603



1500501



1500210

OVERDENTURE STUD



1500534



1500502



1500503



1500504



1500505



1500503



1500504



1500506



1600025

1500204

1500194

1500214

1500205

1500195

O-Ring

NUMBER	PRODUCT NAME	PRICE
1500197	O-Ring Black Rings #2M (6-Pack)	27.00
1500210	O-Ring Mini Implant Analog #2M	23.00
1500532	O-Ring Overdenture Complete #3 w/ housing <i>1 Castable Male, 3 white final rings, 1 red processing ring, 1 metal retainer ring, 1 processing analog</i>	48.00
1500534	O-Ring Overdenture Attachment #3 <i>1 Castable Male, 3 white final rings, 1 red processing ring</i>	40.00
1500530	O-Ring Castable Male Standard #3	10.00
1500154	O-Ring Overdenture Paralleling Mandrel #3	16.00
1500502	O-Ring Metal Retainer Standard #3 (each)	18.00
1500505	O-Ring Red Processing Rings #3 (12-Pack)	27.00
1500503	O-Ring Black Rings Standard #3 (12-Pack)	27.00
1500504	O-Ring White Rings Standard #3 (12-Pack)	23.00
1500506	O-Ring Overdenture Analog Standard #3	16.00
1600025	O-Ring Implant Analog	18.00
1500204	O-Ring Metal Retainer #4	27.00
1500194	O-Ring Black Rings #4 (6-Pack)	30.00
1500214	O-Ring Overdenture Analog #4	27.00
1500205	O-Ring Metal Retainer #5	27.00
1500195	O-Ring Black Rings #5 (6-Pack)	30.00

OVERDENTURE STUD

NUMBER	PRODUCT NAME	PRICE
<p>Sphero Flex Post System: Direct Placement 2.5mm "double sphere" self-parallel attachment 3.40mm tall, 3.55mm Ø tooth surface 4.10mm Ø housing</p>		
0800500	Sphero Flex Post Starter Kit (6-Pack) <i>2 6.5mm Posts, 2 7.5mm Posts, 2 9.0mm posts, 2 drills, insertion tool</i>	580.00
0800510	Sphero Flex Post Short 6.50mm	120.00
0800512	Sphero Flex Post Medium 7.50mm	120.00
0800514	Sphero Flex Post Long 9.00mm	120.00
0800540	Sphero Flex Post Reamer Yellow (6.5 and 7.5mm)	37.00
0800542	Sphero Flex Post Reamer Blue (7.5 and 9.0mm)	37.00
0800161	2.5mm Retention Caps – Light Green (6-Pack) <i>for worn spheres, Rigid Retention (2.2mm)</i>	48.00
0800162	2.5mm Retention Caps – Pink (6-Pack) <i>Standard – 1.65lbs</i>	48.00
0800163	2.5mm Retention Caps – Green (6-Pack) <i>Soft, gummy for patient comfort</i>	48.00
0800164	2.5mm Retention Caps – Yellow (6-Pack) <i>Soft – 1.21lbs</i>	48.00
0800166	2.5mm Retention Caps – White (6-Pack) <i>Strong– 2.87lbs</i>	48.00
0800167	2.5mm Retention Caps – Orange (6-Pack) <i>for worn spheres, Elastic Retention (2.2mm)</i>	48.00
0800194	Cap Insertion Tool 2.5mm/1.8mm	32.00
0800197	Sphero 2.5mm Analog (2-Pack)	38.00



Sphero Post



0800500



0800162



0800163



0800164



0800166



0800167



0800161

OVERDENTURE STUD



0800194

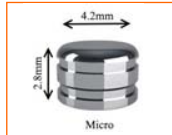

0800280



Reconstruction Kit



Reconstruction Kit



0800180

NUMBER	PRODUCT NAME	PRICE
0800280	1.8mm Stainless Cap Housing (2-Pack)	34.00
0800720	Sphero 1.8mm Analog (2-Pack)	38.00

Sphero Reconstruction Kits: designed to salvage and restore worn mini-implants, direct placement or post coping balls, Sagital Balls (like Bredent VKS and Sagix) and o-ring attachments

0800142	Sphero Reconstruction Kit 1.8mm Ø <i>2.7mm* vertical, 4.3mm Ø</i> <i>2 hollow TiN spheres, 1 strip holder, 2 pink females, 1 insertion tool</i>	180.00
0800280	1.8mm Stainless Cap Housing (2-Pack)	34.00
0800144	Sphero Reconstruction Kit 2.2mm <i>2.7mm* vertical, 4.3mm Ø</i> <i>2 hollow TiN spheres, 1 strip holder, 2 pink females, 1 insertion tool</i>	180.00
0800146	Sphero Reconstruction Kit 2.5mm Ø <i>2.7mm* vertical, 4.8mm Ø</i> <i>2 hollow TiN spheres, 1 strip holder, 2 pink females, 1 insertion tool</i>	180.00
0800180	2.5mm Stainless Cap Housing (2-Pack)	34.00
0800266	1.8mm Retention Caps (6-Pack)	48.00

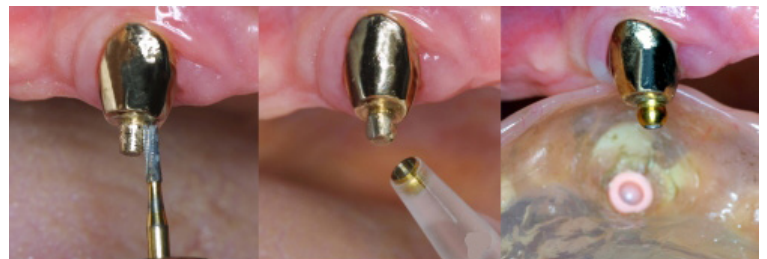
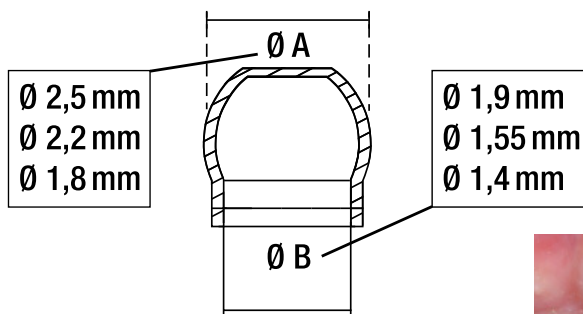

OVERDENTURE STUD

NUMBER	PRODUCT NAME	PRICE
<p>Preci Ball Attachment: 2.25mm Ø spherical attachment with traditional “Dalla Bona” all metal female 3.40mm tall, 4.35mm for threaded male 3.55mm Ø tooth surface, 3.50mm Ø housing</p>		
0101203	Preci Ball 22 Complete PA/TI <i>Pallax male with TI female and spacers</i>	72.00
0101204	Preci Ball 22 Complete Gold/Gold <i>Gold male with Gold female and spacers</i>	118.00
0101218	Preci Ball 22 Complete TI/Castable Male <i>Plastic castable male, TI female and spacers</i>	60.00
0101207	Preci Ball 22 Complete w/Threaded Male <i>Gold threaded base ring, PA male, TI female and spacers</i>	165.00
0101212	Preci Ball 22 Complete Female TI <i>Titanium female with protective ring</i>	53.00
0101213	Preci Ball 22 Complete Female Gold <i>Titanium female with protective ring</i>	53.00
0101220	Preci Ball 22 Castable Male Only	12.00
0101219	Preci Ball 22 Male Only Gold	74.00
0101217	Preci Ball 22 Male Only PA	40.00
0101230	Preci Ball/Clix Analogue (2-Pack)	44.00
0101234	Preci Ball Decrease Retention Tool	54.00
0101236	Preci Ball Increase Retention Tool	54.00
0101232	Preci Ball/Clix Ball Paralleling Mandrel	37.00



0101204



0101218



0101212



0101213



0101220

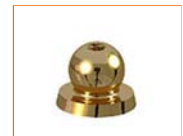

0101219



0101230



0101234

OVERDENTURE STUD

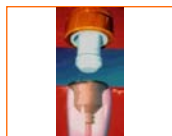

ZAAG

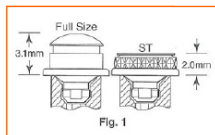

ZAAG Male



Std Female

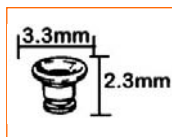

Mini Female



4004011



4009201



4014561



4014572

NUMBER	PRODUCT NAME	PRICE
4004011	ZAAG: low profile resilient direct placement / post-coping overdenture attachment Black Mini: 3.50mm* tall, 3.30mm Ø housing, 3.50mm Ø tooth surface Green Standard: 4.50*mm tall, 3.80mm Ø housing, 4.00mm Ø tooth surface *the ST housing may be used instead of the standard housing to reduce vertical height by 1mm ZAAG Kit of 4 Standard w/1-step drill <i>1 step drill, 4 females, 4 males, 4 impression copings, 4 analogs, 2 parallel posts</i>	290.00
4004010	ZAAG Kit of 4 Standard Refill Kit <i>4 females, 4 males, 4 impression copings, 4 analogs, 2 parallel posts</i>	280.00
4009201	ZEST/ZAAG Denture Cap Tool Kit <i>Zest, ZAAG standard, and ZAAG mini nylon male removal tool and seating tool</i>	64.00
4014561	ZAAG Female (Standard) (2-Pack)	88.00
4014571	ZAAG Impression Male (Standard) (4-Pack)	20.00
4014572	ZAAG Substitute Model Female (Standard) (4-Pack)	44.00
4014573	ZAAG Parallel Post (Standard) (4-Pack)	20.00
4014321-2	ZAAG Denture Cap Male (Standard) (2-Pack)	44.00
4014322	ZAAG Denture Cap Male (Standard) (Oversize)	22.00
4014351	ZAAG Replacement Male (Standard) (4-Pack)	22.00
4014352	ZAAG Replacement Male (Standard) (Oversize) (4-Pack)	22.00
4014549	ZAAG Replacement Male (Standard) (Extra Oversize) (4-Pack)	22.00
4014331	ZAAG ST Cap Male (Standard) (2-Pack)	44.00
4014332	ZAAG ST Cap Male (Standard) (Oversize)	22.00
4014533	ZAAG ST Replacement Male (Standard) (4-Pack)	22.00
4014534	ZAAG ST Replacement Male (Standard) (Oversized) (4-Pack)	22.00

OVERDENTURE STUD

NUMBER	PRODUCT NAME	PRICE
4014562-2	ZAAG Female (Mini) (2-Pack)	88.00
4014581	ZAAG Impression Male (Mini) (4-Pack)	20.00
4014582	ZAAG Substitute Model Female (Mini) (4-Pack)	44.00
4014583	ZAAG Parallel Post (Mini) (4-Pack)	20.00
4014325-2	ZAAG Denture Cap Male (Mini) (2-Pack)	44.00
4014326	ZAAG Male Denture Cap (Mini) (Oversize)	22.00
4014353	ZAAG Replacement Male (Mini) (4-Pack)	22.00
4014354	ZAAG Replacement Male (Mini) (Oversize) (4-Pack)	22.00
4014335	ZAAG ST Denture Cap Male Mini (2-Pack)	44.00
4014543	ZAAG Replacement Male (Mini ST) (4-Pack)	22.00
4014544	ZAAG Replacement Male (Mini ST) (Oversize) (4-Pack)	22.00
4014911	ZAAG One-Step Drill (Standard)	40.00
4014921	ZAAG One-Step Drill (Mini)	40.00
4014922	ZAAG Diamond Bur (Mini)	27.00



4014321



4014351



4014331



4014533



4014562



4014325



4014353



4014543

OVERDENTURE STUD



Shiner



Shiner



Shiner

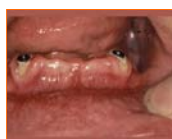

Shiner

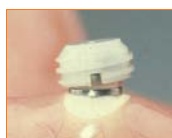

Shiner



Shiner

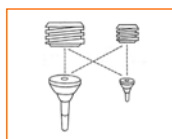

Shiner

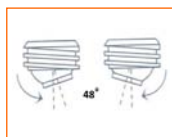

Shiner

NUMBER	PRODUCT NAME	PRICE
<p>Zest Anchors: the original Zest Anchor system has been discontinued, but Preat will maintain parts to service existing patients 3.50mm tall, 3.50mm Ø housing, 4.70mm Ø tooth surface Nylon Males for direct placement in Denture Base Resin (no housing)</p>		
4053262	ZEST ST Male (Combo Pack)	38.00
4053317	ZEST ST Male (Standard) with Red Sleeve (4-Pack)	18.00
4053318	ZEST ST Male (Oversized) with Yellow Sleeve (4-Pack)	18.00
4053319	ZEST ST Male (Extra Oversize) with Orange Sleeve (4-Pack) <i>Nylon Males for use with Metal Denture Caps</i>	18.00
4073261	ZEST ST Replacement Male (Combo Pack)	38.00
4073507	ZEST ST Replacement Male (Standard) (4-Pack)	18.00
4073508	ZEST ST Replacement Male (Oversize) (4-Pack)	18.00
4073509	ZEST ST Replacement Male (Extra Oversize) (4-Pack)	18.00
4073334-2	ZEST ST Cap Male (2-Pack)	38.00
4073335-2	ZEST ST Cap Male (Oversize) (2-Pack)	38.00
4073336-2	ZEST ST Cap Male (Extra Oversize) (2-Pack)	38.00
4053381	ZEST Blue Transfer Male with Blue Sleeve (4-Pack)	18.00
4053563	ZEST Substitute Female (4-Pack)	18.00

OVERDENTURE STUD

NUMBER	PRODUCT NAME	PRICE
--------	--------------	-------

Shiner Magnet Attachment System: Limited parts are available for servicing existing cases. Contact Preat at 1-800-232-7732 for more information.

NOW AVAILABLE FROM PREAT: STECO TITANMAGENTICS®

Available for the following systems:

- Astra Aqua 3.5-4.0
- Ankylos C/X
- Branemark NP-RP-WP
- Camlog 3.3-3.8-4.3-5.0
- Conelog 3.8-4.3
- Straumann RN
- Straumann RN-NC-RC
- Frialit 3.4-3.8-4.5-5.0-6.0
- Endopore 4.1-5.0
- IMZ 3.3-4.0
- Neoss
- Thommen 4.5-5.0
- TriLobe NP-RP-WP
- Zimmer 3.5-4.7

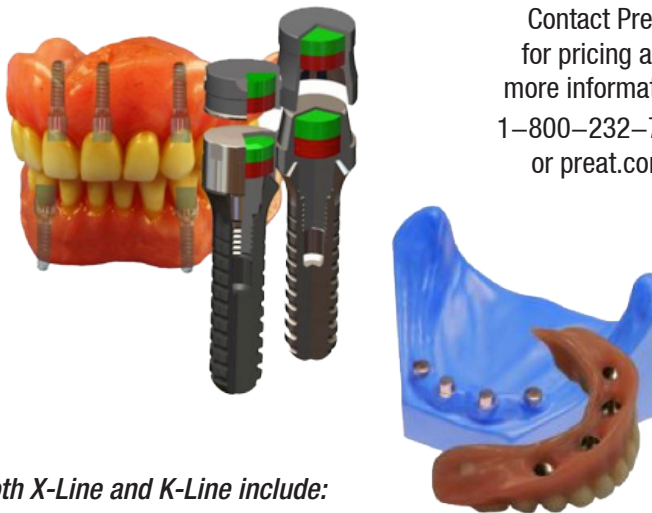

Contact Preat
for pricing and
more information!
1-800-232-7732
or preat.com

Available components for both X-Line and K-Line include:

- Inserts with varying cuff heights
- Denture Magnet
- Positioning Cuff/Resilience Ring
- Impression Posts
- Laboratory Replica
- Torque Wrench Inserts

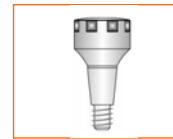
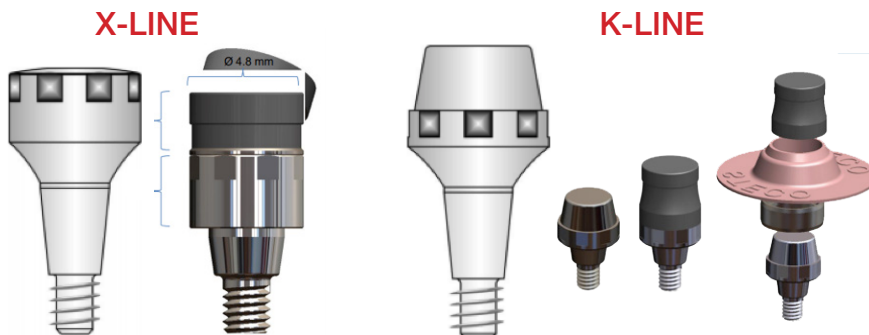

X-Line



X-Line Inserts

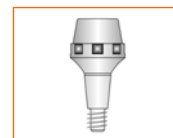

K-Line



K-Line Inserts



Denture Magnets



Positioning Cuff



Impression Posts



Laboratory Replicas

NAVIGATING THE OVERDENTURE STUD ATTACHMENT MAZE



Indications for stud attachments:

- Improving quality of life with only two implants in lower arch, functional capacity increased from 10% to 60%
- Allows independent servicing of attachments
- Provides retention and improved prostheses stability



LOCATOR®

- Lowest profile, 2.73mm x 5.5mm
- 8 different retention levels
- Self-aligning function 40°
- Nylon male stays in contact with abutment, housing pivots around nylon male, to reduce abutment wear

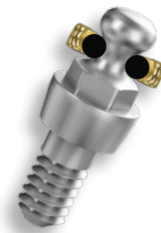

O-Rings

- 6mm x 4.5mm tall
- 2 retention levels
- Minimal angulation correction, 10°
- The most resilient attachment system, protects weaker abutments



Clix

- Small size, 4 x 4mm
- 3 different retention levels
- Angle correction up to 30°
- Great for patients with hygiene issues
- Female makes patient pleasing audible Clix when engaged for security and confidence.
- Ideal for anterior maxillae



Titanmagnets®

- Ø 5.2 mm x 5.0mm
- Provides lateral stability
- No path of insertion; corrects up to 15° of divergence
- Ideal for patients with limited dexterity

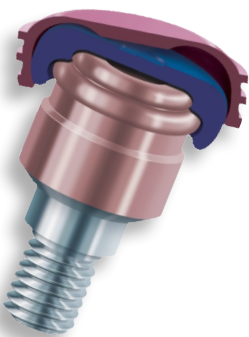

LOCATOR R-Tx®

- Low profile, 3.1mm x 5.6mm
- 4 different retention levels
- Self-aligning function 60°
- Nylon male stays in contact with abutment, housing pivots around nylon male, to reduce abutment wear

IMPLANT ABUTMENTS/ATTACHMENTS

NUMBER	PRODUCT NAME	PRICE
<p>Clix Attachment: 2.25mm spherical attachment with slotted plastic female to engage a larger surface area of the sphere and reduce wear. This unique female makes an audible click to ensure prosthesis security. Housing may be paralleled to correct up to 30° divergence requires: 4.0mm vertical, 4.0mm Ø</p>		
1608001C	Clix Complete Ball Abutment for Nobel Active NP x 1mm	95.00
1608002C	Clix Complete Ball Abutment for Nobel Active NP x 2mm	95.00
1608003C	Clix Complete Ball Abutment for Nobel Active NP x 3mm	95.00
1608004C	Clix Complete Ball Abutment for Nobel Active NP x 4mm	95.00
1608005C	Clix Complete Ball Abutment for Nobel Active NP x 5mm	95.00
1608006C	Clix Complete Ball Abutment for Nobel Active NP x 6mm	95.00
1600901C	Clix Complete Ball Abutment for Nobel Active RP x 1mm	95.00
1600902C	Clix Complete Ball Abutment for Nobel Active RP x 2mm	95.00
1600903C	Clix Complete Ball Abutment for Nobel Active RP x 3mm	95.00
1600904C	Clix Complete Ball Abutment for Nobel Active RP x 4mm	95.00
1600905C	Clix Complete Ball Abutment for Nobel Active RP x 5mm	95.00
1600906C	Clix Complete Ball Abutment for Nobel Active RP x 6mm	95.00
1601501C	Clix Complete Ball Abutment for Straumann Bone Level NC x 1mm	95.00
1601502C	Clix Complete Ball Abutment for Straumann Bone Level NC x 2mm	95.00
1601503C	Clix Complete Ball Abutment for Straumann Bone Level NC x 3mm	95.00
1601504C	Clix Complete Ball Abutment for Straumann Bone Level NC x 4mm	95.00
1601505C	Clix Complete Ball Abutment for Straumann Bone Level NC x 5mm	95.00
1601506C	Clix Complete Ball Abutment for Straumann Bone Level NC x 6mm	95.00

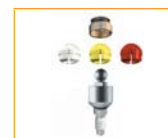

Clix



1608001C



1608003C

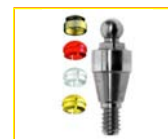

1600902C



1600904C

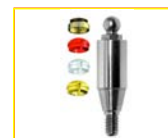

1600906C



1601502C



1601504C

IMPLANT ABUTMENTS/ATTACHMENTS



1601401C



1601403C



1600101C



1600104C



1600106C



1600203 C



1600205C



1600302C

NUMBER	PRODUCT NAME	PRICE
1601400C	Clix Complete Ball Abutment for Straumann Bone Level RC x 1mm	95.00
1601401C	Clix Complete Ball Abutment for Straumann Bone Level RC x 2mm	95.00
1601402C	Clix Complete Ball Abutment for Straumann Bone Level RC x 3mm	95.00
1601403C	Clix Complete Ball Abutment for Straumann Bone Level RC x 4mm	95.00
1601404C	Clix Complete Ball Abutment for Straumann Bone Level RC x 5mm	95.00
1601405C	Clix Complete Ball Abutment for Straumann Bone Level RC x 6mm	95.00
1600100C	Clix Complete Ball Abutment for Zimmer TSV NP x 1mm	95.00
1600102C	Clix Complete Ball Abutment for Zimmer TSV NP x 2mm	95.00
1600103C	Clix Complete Ball Abutment for Zimmer TSV NP x 3mm	95.00
1600104C	Clix Complete Ball Abutment for Zimmer TSV NP x 4mm	95.00
1600105C	Clix Complete Ball Abutment for Zimmer TSV NP x 5mm	95.00
1600106C	Clix Complete Ball Abutment for Zimmer TSV NP x 6mm	95.00
1600200C	Clix Complete Ball Abutment for Zimmer TSV RP x 1mm	95.00
1600202C	Clix Complete Ball Abutment for Zimmer TSV RP x 2mm	95.00
1600203C	Clix Complete Ball Abutment for Zimmer TSV RP x 3mm	95.00
1600204C	Clix Complete Ball Abutment for Zimmer TSV RP x 4mm	95.00
1600205C	Clix Complete Ball Abutment for Zimmer TSV RP x 5mm	95.00
1600206C	Clix Complete Ball Abutment for Zimmer TSV RP x 6mm	95.00
1600302C	Clix Complete Ball Abutment for Zimmer TSV WP x 2mm	95.00
1600304C	Clix Complete Ball Abutment for Zimmer TSV WP x 4mm	95.00

IMPLANT ABUTMENTS/ATTACHMENTS

NUMBER	PRODUCT NAME	PRICE
1600400C	Clix Complete Ball Abutment for or Tri-Lobe NP x 0mm	95.00
1600401C	Clix Complete Ball Abutment for Tri-Lobe NP x 1mm	95.00
1600402C	Clix Complete Ball Abutment for Tri-Lobe NP x 2mm	95.00
1600403C	Clix Complete Ball Abutment for Tri-Lobe NP x 3mm	95.00
1600404C	Clix Complete Ball Abutment for Tri-Lobe NP x 4mm	95.00
1600405C	Clix Complete Ball Abutment for Tri-Lobe NP x 5mm	95.00
1600406C	Clix Complete Ball Abutment for Tri-Lobe NP x 6mm	95.00
1600500C	Clix Complete Ball Abutment for Tri-Lobe RP x 0mm	95.00
1600501C	Clix Complete Ball Abutment for Tri-Lobe RP x 1mm	95.00
1600502C	Clix Complete Ball Abutment for Tri-Lobe RP x 2mm	95.00
1600503C	Clix Complete Ball Abutment for Tri-Lobe RP x 3mm	95.00
1600504C	Clix Complete Ball Abutment for Tri-Lobe RP x 4mm	95.00
1600505C	Clix Complete Ball Abutment for Tri-Lobe RP x 5mm	95.00
1600506C	Clix Complete Ball Abutment for Tri-Lobe RP x 6mm	95.00
1602102C	Clix Complete Ball Abutment for Astra Aqua 3.5/4.0mm x 2mm	95.00
1602104C	Clix Complete Ball Abutment for Astra Aqua 3.5/4.0mm x 4mm	95.00
1602202C	Clix Complete Ball Abutment for Astra Lilac 4.5/5.0mm x 2mm	95.00
1602204C	Clix Complete Ball Abutment for Astra Lilac 4.5/5.0mm x 4mm	95.00
1601602C	Clix Complete Ball Abutment for Biomet 3i Certain 3.4mm x 2mm	95.00
1601604C	Clix Complete Ball Abutment for Biomet 3i Certain 3.4mm x 4mm	95.00



1600401C



1600402C



1600404C



1600406C

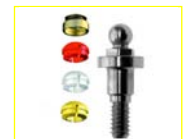

1600501C



1600504C



1600505C



1600506C

IMPLANT ABUTMENTS/ATTACHMENTS



1600303C



1600305C



1600020



1600030



011222



0101240



0101232W-6



0101231-6

NUMBER	PRODUCT NAME	PRICE
1601702C	Clix Complete Ball Abutment for Biomet 3i Certain 4.1mm x 2mm	95.00
1601704C	Clix Complete Ball Abutment for Biomet 3i Certain 4.1mm x 4mm	95.00
1600301C	Clix Complete Ball Abutment for Straumann RN x 0mm	95.00
1600302C	Clix Complete Ball Abutment for Straumann RN x 1mm	95.00
1600303C	Clix Complete Ball Abutment for Straumann RN x 2mm	95.00
1600304C	Clix Complete Ball Abutment for Straumann RN x 3mm	95.00
1600305C	Clix Complete Ball Abutment for Straumann RN x 4mm	95.00
1601002C	Clix Complete Ball Abutment for Neoss 3.5-6.0mm x 2mm	95.00
1601004C	Clix Complete Ball Abutment for Neoss 3.5-6.0mm x 4mm	95.00
1600020	Clix Implant Ball Analog	21.00
1600030	Clix Latch Driver	40.00
1600035	Latch to Square Driver Insert	40.00
011222	Clix Female Insertion Tool	34.00
0101240	Clix Complete Female TI housing and yellow female	45.00
0101232W-6	Clix White Females- Reduced (6-Pack) white = 1.7lbs retention	36.00
0101232W-50	Clix White Females- Reduced (50-Pack)	200.00
0101231-6	Clix Yellow Females- Standard (6-Pack) yellow = 2.5 lbs retention	36.00
0101231-50	Clix Yellow Females- Standard (50-Pack)	200.00

IMPLANT ABUTMENTS/ATTACHMENTS

NUMBER	PRODUCT NAME	PRICE
0101233-6	Clix Red Females- Increased (6-Pack) red = 3.3 lbs retention	36.00
0101233-50	Clix Red Females- Increased (50-Pack)	200.00
0112340	Clix Combi Females 2 white, 2 yellow, 2 red Clix Females	36.00



0101233-6



0112340

O-Ring Attachment: the extremely resilient titanium O-Ring attachment requires 4.0mm vertical, 5.0mm Ø All abutments include metal retainer ring, 1 red processing ring, and 3 black rubber rings

1600801C	O-Ring Abutment Zimmer TSV 3.5 X 1mm	75.00
1600802C	O-Ring Abutment Zimmer TSV 3.5 X 2mm	75.00
1600803C	O-Ring Abutment Zimmer TSV 3.5 X 3mm	75.00
1600804C	O-Ring Abutment Zimmer TSV 3.5 X 4mm	75.00
1600805C	O-Ring Abutment Zimmer TSV 3.5 X 5mm	75.00
1600806C	O-Ring Abutment Zimmer TSV 3.5 X 6mm	75.00
1600811C	O-Ring Abutment Zimmer TSV 4.5 X .5mm	75.00
1600812C	O-Ring Abutment Zimmer TSV 4.5 X 2mm	75.00
1600813C	O-Ring Abutment Zimmer TSV 4.5 X 3mm	75.00
1600814C	O-Ring Abutment Zimmer TSV 4.5 X 4mm	75.00
1600815C	O-Ring Abutment Zimmer TSV 4.5 X 5mm	75.00
1600816C	O-Ring Abutment Zimmer TSV 4.5 X 6mm	75.00
1600821C	O-Ring Abutment Branemark RP x 1mm	75.00
1600822C	O-Ring Abutment Branemark RP x 2mm	75.00



Red Proc. Ring



Black Ring.

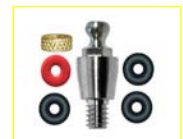

1600801C

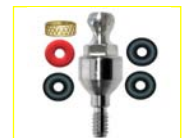

1600802C



1600804C

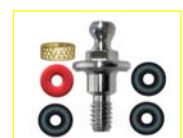

1600811C

IMPLANT ABUTMENTS/ATTACHMENTS

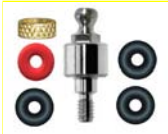

1600813C



1600815C



1500502



1500503



1500505



1500504



1600025



4008049

NUMBER	PRODUCT NAME	PRICE
1600823C	O-Ring Abutment Branemark RP x 3mm	75.00
1600824C	O-Ring Abutment Branemark RP x 4mm	75.00
1600825C	O-Ring Abutment Branemark RP x 5mm	75.00
1600826C	O-Ring Abutment Branemark RP x 6mm	75.00
1500502	O-Ring Metal Retainer Standard #3 (each)	18.00
1500505	O-Ring Red Processing Rings #3 (12-Pack)	27.00
1500503	O-Ring Black Rings Standard #3 (12-Pack)	27.00
1500504	O-Ring White Rings Standard #3 (12-Pack)	23.00
1600025	O-Ring Implant Analog	18.00
1600030	O-Ring/Clix Latch Driver	40.00
1600035	Latch to Square Driver Insert	40.00
4008049	O-Ring Insertion Tool	62.00

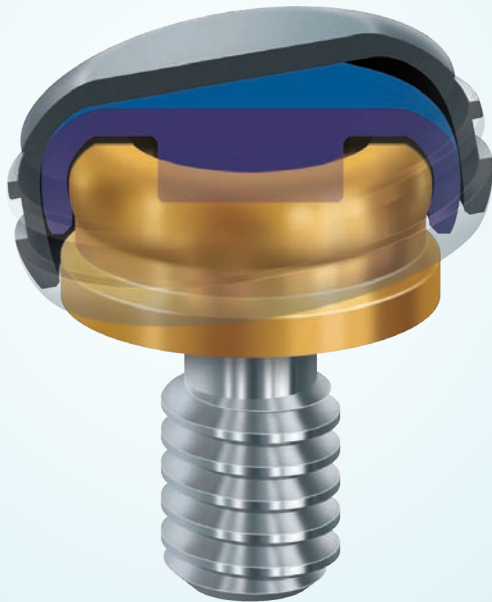

LOCATOR®
Attachment System

IF YOU'RE NOT USING LOCATOR® PIVOT TECHNOLOGY, HERE'S A CASE FOR CHANGING DIRECTION

Dual retention, pivoting action reduces the wear and tear even on divergent implants.

We pioneered self-aligning overdenture attachments to combat the damage done by the improper seating of overdentures. Today, over 70 manufacturers have partnered to customize our LOCATOR® pivoting technology abutments to be interface compatible with over 350 different implant products.

Patients the world over are enjoying an unprecedented quality of life, as they no longer have to worry about ill-fitting dentures. All in all, a compelling argument for you to consider incorporating the industry's most comprehensive overdenture attachment system into your practice, regardless of the implant system you prefer.

For more information about the LOCATOR® Attachment System, please call 800-232-7732 or visit www.preat.com.

⚠ CAUTION

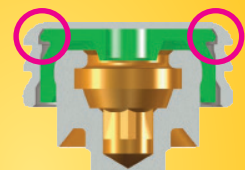

Beware of other "look-alike" products—they do NOT have the unique innovations provided by the patented product. The "look-alike" products do not have the PREAT pivoting technology and in fact, are designed not to pivot, which is a key performance feature of the LOCATOR® System.

LOCATOR® is a registered trademark of Zest Anchors, LLC

IMPLANT ABUTMENTS/ATTACHMENTS



Locator



Locator



4008260



4008913



4008926



4008393



4008394



4008505

NUMBER	PRODUCT NAME	PRICE
<p>LOCATOR®: the most popular stud attachment in the world due to its angle correction, ease of use, low profile 9 different retention levels to meet patient's needs, and patented PIVOT between the housing and nylon male that reduces potential wear on the abutment. *Beware imitations that do not pivot* 2.73mm vertical, 5.45mm Ø</p>		
4008260	LOCATOR® 35n Square Driver (15mm) <i>For use with Straumann torque wrenches</i>	53.00
4008280	LOCATOR® 35n Square Driver (21mm) <i>For use with Straumann torque wrenches</i>	53.00
4008913	LOCATOR® Insert Driver (Latch 23mm)	53.00
4008914	LOCATOR® Insert Driver (Latch 29mm)	53.00
4008926	LOCATOR® Square Insert Driver (15mm)	53.00
4008927	LOCATOR® Square Insert Driver (21mm)	53.00
4008393	LOCATOR® Core Tool	90.00
4008390	LOCATOR® Gold Driver	42.00
4008397	LOCATOR® Male Removal Tool	37.00
4008394	LOCATOR® Abutment Carrier (4-Pack)	23.00
4009006	LOCATOR® Demo Model	240.00
4009014	LOCATOR® Root Model	215.00
4009015	LOCATOR® Implant Model w/External Hexed Implants	240.00
4008505	LOCATOR® Impression Coping (4-Pack)	75.00
4008505-20	LOCATOR® Impression Coping (20-Pack)	335.00
4008530	LOCATOR® Female Analog (4.0mm) (4-Pack) <i>The 4mm Ø analog is for Narrow and Regular Platform Implants</i>	75.00
4008530-20	LOCATOR® Female Analog (4.0mm) (20-Pack)	338.00

IMPLANT ABUTMENTS/ATTACHMENTS

NUMBER	PRODUCT NAME	PRICE
4008514	LOCATOR® Block Out Spacer (20-Pack)	20.00
4008515	LOCATOR® Female Analog (5.0mm) (4-Pack)	25.00
4008515-20	LOCATOR® Processing Replacement Male (Black) (20-Pack)	111.00
4008516	LOCATOR® Female Analog (5.0mm) (4-Pack) <i>The 5mm Ø analog is for Wide Platform Implants & Natural Teeth</i>	75.00
4008516-20	LOCATOR® Female Analog (5.0mm) (20-Pack)	338.00
4008517	LOCATOR® Parallel Post (4-Pack)	20.00
4008524	LOCATOR® Replacement Male (Clear) (4-Pack)	25.00
4008524-20	LOCATOR® Replacement Male (Clear) (20-Pack)	111.00
4008527	LOCATOR® Light Retention Replacement Male (Pink) (4-Pack)	25.00
4008527-20	LOCATOR® Light Retention Replacement Male (Pink) (20-Pack)	112.50
4008529	LOCATOR® Extra Light Retention Replacement Male (Blue) (4-Pack)	25.00
4008529-20	LOCATOR® Replace Male Blue- Decreased (20-Pack)	111.00
4008547	LOCATOR® Extended Range Replacement Male (Green) (4-Pack)	25.00
4008547-20	LOCATOR® Extended Range Replacement Male (Green) (20-Pack)	112.50
4008548	LOCATOR® Extra Light Retention Extended Range Replacement Male (Red) (4-Pack)	25.00
4008548-20	LOCATOR® Extra Light Retention Extended Range Replacement Male (Red) (20-Pack)	112.50
4008548	LOCATOR® Extra Light Retention Extended Range Replacement Male (Red) (4-Pack)	25.00
4008548-20	LOCATOR® Extra Light Retention Extended Range Replacement Male (Red) (20-Pack)	112.50
4008915	LOCATOR® Extended Range Replacement Male (Orange) (4-Pack)	25.00
4008915-20	LOCATOR® Extended Range Replacement Male (Orange) (20-Pack)	112.50



4008530



4008516



4008515



4008524



4008527



4008529



4008547



4008548

IMPLANT ABUTMENTS/ATTACHMENTS



4008558



4008559



4008026



4008569



4008510



4008519



4008540



4008550

NUMBER	PRODUCT NAME	PRICE
4008558	LOCATOR® Zero Retention Extended Range Replacement Male (Gray) (4-Pack)	25.00
4008558-20	LOCATOR® Zero Retention Extended Range Replacement Male (Gray) (20-Pack)	112.50
4008559	LOCATOR® High Retention Replacement Male (Purple) (4-Pack)	35.00
4008026	LOCATOR® Bar Processing Replacement Male (Yellow) (4-Pack)	25.00
4008026-20	LOCATOR® Bar Processing Replacement Male (Yellow) (20-Pack)	112.50
4008569	LOCATOR® Processing Spacer (4-Pack)	34.00
4008569-20	LOCATOR® Processing Spacer (20-Pack)	150.00
4008510-4	LOCATOR® Replacement Denture Cap Male Assembly (4-Pack)	60.00
4008510-10	LOCATOR® Replacement Denture Cap Male Assembly (10-Pack)	135.00
4008519-2	LOCATOR® Male Processing Package (2-Pack) <i>Ti housing, blackout spacer, blue / pink / clear males</i>	71.00
4008519-10	LOCATOR® Male Processing Package (10-Pack)	320.00
4008540-2	LOCATOR® Extended Range Male Processing Package (2-Pack) <i>Ti housing, blackout spacer, red / orange / green males</i>	71.00
4008540-10	LOCATOR® Extended Range Male Processing Package (10-Pack)	320.00
4008550-2	LOCATOR® Male Processing Package SS (2-Pack). <i>Stainless Steel housing ideal for welding to CoCr framework SS housing, blackout spacer, blue / pink / clear males</i>	71.00
4008550-10	LOCATOR® Male Processing Package SS (10-Pack)	320.00
4008028-2	LOCATOR® Bar Male Processing (2-Pack) <i>Ti housing. w/ yellow, 2 block. spacers, blue / pink / clear</i>	71.00
4008028-10	LOCATOR® Bar Male Processing (10-Pack)	320.00
4008010	LOCATOR® Refill Kit <i>Four 0° females, 2 parallel posts, 4 complete males</i>	355.00

IMPLANT ABUTMENTS/ATTACHMENTS

NUMBER	PRODUCT NAME	PRICE
4008011	LOCATOR® Starter Kit <i>Spotface Drill, Pilot Drill, Four 0° females, 4 complete males, 2 parallel posts</i>	380.00
4008050	LOCATOR® Refill Coping Kit <i>4 Cast-to females w/parallel posts, 4 complete males</i>	355.00
4008051	LOCATOR® Coping Kit <i>Spotface Drill, Pilot Drill, 4 Cast-to females w/parallel posts, 4 complete males</i>	380.00
4008070	LOCATOR® Refill Mixed Kit <i>Two 0°, One 10°, One 20° females, 2 parallel posts, 4 complete males</i>	355.00
4008071	LOCATOR® Mixed Kit <i>Spotface Drill, Pilot Drill, Two 0°, One 10°, One 20° females, 2 parallel posts, 4 complete males</i>	380.00
4008922	LOCATOR® Spotface Diamond Bur	31.00
4008924	LOCATOR® Pilot Drill	21.00
4008520-2	LOCATOR® 0 Degree Female (2-Pack)	102.00
4008520-10	LOCATOR® 0 Degree Female (10-Pack)	450.00
4008521-2	LOCATOR® 10 Degree Female (2-Pack)	102.00
4001747	LOCATOR® Retrofit Kit for Worn ERA Root Attachments (2-Pack) <i>Includes LOCATOR® Retrofit, Parallel Post, Weep Hole Alignment Pin</i>	99.00
4008521-10	LOCATOR® 10 Degree Female (10-Pack)	450.00
4008522-2	LOCATOR® 20 Degree Female (2-Pack)	102.00
4008522-10	LOCATOR® 20 Degree Female (10-Pack)	450.00
4008528-2	LOCATOR® 0 Degree Cast-to Female (2-Pack)	102.00
4008528-10	LOCATOR® 0 Degree Cast-to Female (10-Pack)	450.00



4008028



Locator



4008011



4008071



4008922



4008924

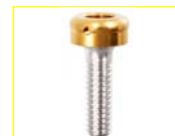

4008520

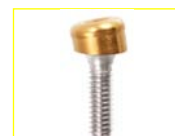

4008521

IMPLANT ABUTMENTS/ATTACHMENTS

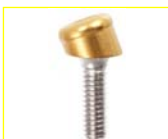

4008522



4008528

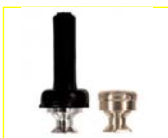

4008586



4008588



4008589



4008014



4008016



4009102

NUMBER	PRODUCT NAME	PRICE
4008586-2	LOCATOR® Cast-To Bar Female (2-Pack)	90.00
4008586-10	LOCATOR® Cast-To Bar Female (10-Pack)	427.00
4008587-2	LOCATOR® Bar Female 2-56 Thread (2-Pack)	90.00
4008588-2	LOCATOR Laser Bar Female, Titanium (2-Pack)	90.00
4008588-10	LOCATOR® Laser Bar Female, Titanium (10-Pack)	427.00
4008589-2	LOCATOR® Bar Female, 2.0mm Thread (2-Pack)	90.00
4008589-10	LOCATOR® Bar Female, 2.0mm Thread (10-Pack)	427.00
4008590-2	LOCATOR® Laser Bar Female, Stainless Steel (2-Pack)	90.00
4008590-10	LOCATOR® Laser Bar Female, Stainless Steel (10-Pack)	427.00
4008013	LOCATOR® 2-56 castable sleeve	61.00
4008014	LOCATOR® 2mm Castable Threaded Inserts (10-Pack)	61.00
4008016	LOCATOR® Tap Holder	66.00
4009102	1.7mm Bar Drill (2.0mm Thread)	17.00
4009103	1.8mm Bar Drill 2-56 Thread	17.00
4009104	2.0mm Bar Tap (2.0mm Thread)	31.00
4009105	LOCATOR® 2-56 Bar Tap (2-56 Thread)	31.00
4009107	LOCATOR® Paralleling Mandrel for Bar Female	42.00
4008909-2	LOCATOR® for Multi-Unit Abutment TI (2-Pack)	265.00

LOCATOR® RETENTION INSERTS

- 

Grey Extended Range
0.0 lbs Retention
- 

White Standard
5.0 lbs Retention
- 

Black Processing
& Reline
- 

Red Extended Range
1.0 lbs Retention
- 

Pink Standard
3.0 lbs Retention
- 

Yellow Processing
& Reline
- 

Orange Extended Range
2.0 lbs Retention
- 

Blue Standard
1.5 lbs Retention
- 

Green Extended Range
4.0 lbs Retention
- 

Purple Extended Range <NOT meant to be used like a standard insert
<Temporary solution until new abutment is replaced
8.0 lbs Retention

DIMENSIONAL SPECIFICATIONS

LOCATOR® IMPLANT ATTACHMENTS

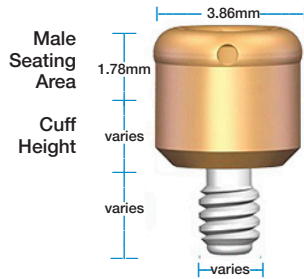

LOCATOR® DENTURE CAP AND BLACK PROCESSING MALE

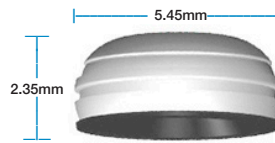

Cuff height, thread diameter and thread length vary by implant system

LOCATOR® BAR ATTACHMENTS

Drill and Tap

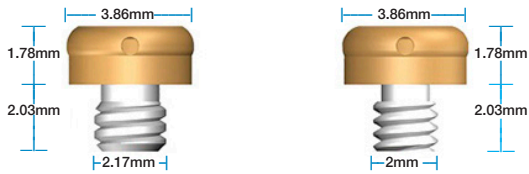

Laser Weld

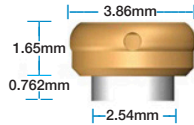

Cast-to

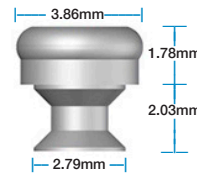

LOCATOR® ROOT ATTACHMENTS

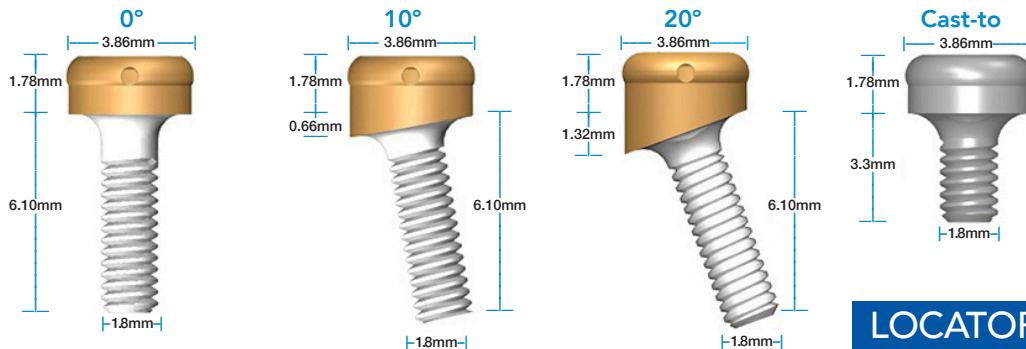

LOCATOR® FOR MULTI-UNIT

LOCATOR® PIVOTING FUNCTION

Standard LOCATOR®

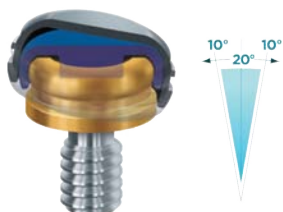

Extended Range LOCATOR®

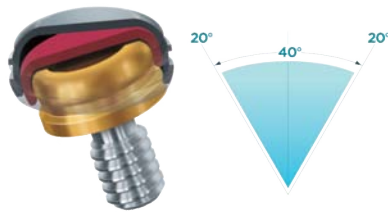

LOCATOR® ABUTMENT LISTING CONT'D

42

LOCATOR® Abutment

IMPLANT ABUTMENT DESCRIPTION	ABUTMENT TISSUE CUFF HEIGHT							
	0.0MM	0.73MM	1.0MM	2.0MM	3.0MM	4.0MM	5.0MM	6.0MM
AB DENTAL								
3.75mmD (NP)	8661		8662	8663 2.5mm	8664 3.5mm	8665 4.5mm	8625 5.5mm	8626 6.5mm
4.5mmD (WP)	8671		8672	8673	8674	8675	8627	8628
ALPHA BIO IMPLANT								
3.5mmD		1192 0.3mm	1193	1194	1195	1196	1197	1198
ASTRA								
TX 3.5mm/4.0mmD			8115	8116	8117	8118	8119	
TX 4.5mm/5.0mmD		8686 0.5mm		8687	8688	8689	8690	
M2 Thread (old style) 3.5mmD		8636 0.81mm		8637	8638	8639	8640	
M2 Thread (old style) 4.0mmD ST		8656 0.5mm		8657	8658	8659	8660	
EV 3.6mmD			2790	2791	2792	2793	2794	
EV 4.2mmD			2795	2796	2797	2798	2799	
EV 4.8mmD			2800	2801	2802	2803	2804	
BICON								
2.0 Post			8746	8747	8748	8749	8750	
3.0 Post			8930	8931	8932	8933	8934	
BIOHORIZONS								
External 3.5mmD (Ex Hex)			8531 1.25mm	8532	8533	8534	8535	
External 4.0mmD (Ex Hex)			8541	8542	8543	8544	8545	
External 5.0mmD (Ex Hex)			8551 1.5mm	8552 2.5mm	8553 3.5mm	8554 4.5mm	8555 5.5mm	
Internal 3.0mmD			1927	1928	1929	1930		
Internal 3.5mm/3.8mmD	8661		8662	8663 2.5mm	8664 3.5mm	8665 4.5mm	8625 5.5mm	8626 6.5mm
Internal 4.0mm/4.5mm/4.6mmD	8671		8672	8673	8674	8675	8627	8628
Internal 5.7mm/5.8mmD			8190	8191	8192	8193	8194	8195
BIO-LOK								
3.45mm (Ex Hex & Internal Connection)			8561	8562	8563	8564	8565	
4.0mm (Ex Hex & Internal Connection)		8681		8682	8683	8684	8685	8696
5.0mm (Ex Hex and Internal Connection)			8581 1.4mm	8582	8583	8584	8585	
BIOMET (3i)								
Certain 3.4mmD			8431	8432	8433	8434	8435	8436
Certain 4.1mmD (Compatible with 5.0mm and 6.0mm)		8630		8631	8632	8633	8634	8635
MicroMiniPlant 3.4mmD (Ex Hex)			8441	8442	8443	8444	8445	8446

LOCATOR® ABUTMENT LISTING CONT'D

IMPLANT ABUTMENT DESCRIPTION	ABUTMENT TISSUE CUFF HEIGHT							
	0.0MM	0.73MM	1.0MM	2.0MM	3.0MM	4.0MM	5.0MM	6.0MM
BIOMET (3i) cont'd								
MiniPlant 3.75mmD (Ex Hex)		8681		8682	8683	8684	8685	8696
Cylindrical 4.0mm Diameter (Ex Hex)		8681		8682	8683	8684	8685	8696
External 5.0mm Diameter (Ex Hex)		8820 0.6mm		8821	8822	8823	8824	
TG (Internal Connection)			8621 1.25mm	8622 2.25mm	8623 3.25mm	8624 4.25mm		
BLUE SKY BIO								
Internal Hex 3.7mmD	8661		8662	8663 2.5mm	8664 3.5mm	8665 4.5mm	8625 5.5mm	8626 6.5mm
Internal Hex 4.7mmD	8671		8672	8673	8674	8675	8627	8628
Trilobe 3.5mmD (NP)	8756		8757	8758	8759	8760	8734	8735
Trilobe 4.3mmD (RP)	8761		8762	8763	8764	8765	8753	8754
Trilobe 5.0mmD (WP)			8766	8767	8768	8769	8770	
One Stage Regular		8950		8951	8952	8953	8954	8955
BTI -BIOTECHNOLOGY INSTITUTE SL								
External Hex 4.1mmD		8681		8682	8683	8684	8685	8696
External Hex 5.5mmD				8302	8303	8304	8305	8306
DENTSPLY / FRIADENT								
Ankylos C/X (Conical Connection)				1729	1730	1731	1732	1733
Frialit-2 / Xive 3.4mm Diameter			8805	8806	8807	8808	8809	
Frialit-2 / Xive 3.8mm Diameter			8810	8811	8812	8813	8814	
Frialit-2 / Xive 4.5mm Diameter			8815	8816	8817	8818	8819	
Frialit-2 / Xive 5.5mm Diameter			8139 1.3mm	8140	8141	8142	8143	
DENTIUM USA								
Implantium / Superline 3.4mm/3.8mm, 4.3mm/4.8mm, 4.8mmW		8656 0.5mm		8657	8658	8659	8660	
DSI								
Dio SM 3.8mmD (Narrow)			1351	1352	1353	1354	1355	1356
Dio SM 4.5mm/5.3mmD (Regular)			1361	1362	1363	1364	1365	1366
GLOBAL IMPLANT SOLUTIONS, LLC								
Osseolink 4.0mmD		1910 0.2mm	1911	1912	1913	1914	1915	
IMTEC								
Endure 4.3mmD (Internal Hex)		8994 0.63mm		8995	8996	8997	8998	
Self Tapping 3.75mmD (Ex Hex)		8681		8682	8683	8684	8685	8696
Universal 3.4mm/4.0mmD (Ex Hex)		8681		8682	8683	8684	8685	8696
Mini 3.3mmD (Ex Hex)		8856 0.91mm		8857	8858	8859	8860	

LOCATOR® ABUTMENT LISTING CONT'D

44

LOCATOR® Abutment

IMPLANT ABUTMENT DESCRIPTION	ABUTMENT TISSUE CUFF HEIGHT							
	0.0MM	0.73MM	1.0MM	2.0MM	3.0MM	4.0MM	5.0MM	6.0MM
IMPLANT DIRECT								
InterActive / SwishActive 3.0mmD (NP)			2069	2070	2071	2072	2073	2074
InterActive / SwishActive 3.4mmD (RP)			2075	2076	2077	2078	2079	2080
Legacy 3.0mmD (Internal Hex)		2308 0.75mm		2309	2310	2311	2312	2313
Legacy 3.5mmD (Internal Hex)	8661		8662	8663 2.5mm	8664 3.5mm	8665 4.5mm	8625 5.5mm	8626 6.5mm
Legacy 4.5mmD (Internal Hex)	8671		8672	8673	8674	8675	8627	8628
Legacy 5.7mmD (Internal Hex)			1471	1472	1473	1474	1475	1476
RePlus / RePlant / ReActive 3.5mmD (Trilobe NP)	8756		8757	8758	8759	8760	8734	8735
RePlus / RePlant / ReActive 4.3mmD (Trilobe RP)	8761		8762	8763	8764	8765	8753	8754
RePlus / RePlant / ReActive 5.0mmD (Trilobe WP)			8766	8767	8768	8769	8770	
ScrewPlant 3.7mmD			1371	1372	1373	1374	1375	1376
ScrewPlant 4.7mmD			1381 1.5mm	1382	1383	1384	1385	1386
ScrewPlant 5.7mmD				1391	1392	1393	1394	1395
ScrewInDirect 5.0mmD				1250	1251	1252	1253	1254
SwishTapered / SwishPlus 3.7mmD		1821 0.4mm	1822	1823	1824	1825	1826	
SwishTapered / SwishPlus 4.8mmD		8950		8951	8952	8953	8954	8955
IMZ								
3.3mmD (Ex Hex)		8681		8682	8683	8684	8685	8696
4.0mmD (Ex Hex)		8681		8682	8683	8684	8685	8696
3.3mmD (Non-Hex)	8020		8021	8022	8023	8024	8025	
4.0mmD (Non-Hex)	8030 0.35mm		8031	8032	8033	8034	8035	
INTRA-LOCK SYSTEM INTERNATIONAL								
Threaded 3.75mm/4.0mmD (Ex Hex)		8681		8682	8683	8684	8685	8696
Threaded Conic 4.3mmD (Ex Hex)			8781	8782	8783	8784	8785	
Threaded 4.75mmD (Ex Hex)			8727 1.42mm	8728	8729	8730	8731	
Threaded Conic 5.0mmD (Ex Hex)			8727 1.42mm	8728	8729	8730	8731	
KEYSTONE / LIFECORE BIOMEDICAL								
3.3mm/4.0mmD (Ex Hex)		8681		8682	8683	8684	8685	8696
Stage-1 Regular Diameter		8950		8951	8952	8953	8954	8955
Renova 3.75mmD (Internal Connection)	8090		8091	8092	8093	8094	8095	8096
Revona 4.5mm/4.75mmD (Internal Connection)		8125 0.63mm		8126	8127	8128	8129	8130
Restore SD 3.3mm/3.4mmD (Ex Hex)			8196	8197	8198	8199	8200	
Restore RD 3.75mm/4.0mmD (Ex Hex)		8681		8682	8683	8684	8685	8696

LOCATOR® ABUTMENT LISTING CONT'D

IMPLANT ABUTMENT DESCRIPTION	ABUTMENT TISSUE CUFF HEIGHT							
	0.0MM	0.73MM	1.0MM	2.0MM	3.0MM	4.0MM	5.0MM	6.0MM
KEYSTONE / LIFECORE BIOMEDICAL cont'd								
Restore WD 5.0mm/6.0mmD (Ex Hex)			8727 1.42mm	8728	8729	8730	8731	
Sustain 4.2mmD (Ex Hex)		8681		8682	8683	8684	8685	8696
Sustain 4.0mm/4.7mmD	8651		8652	8653	8654	8655		
MEGAGEN / INTEGRATED DENTAL SYSTEMS								
AnyRidge (Internal Connection)			2100	2101	2102	2103	2104	2105
MIS - MEDICAL IMPLANT SYSTEM								
Internal Hex 3.75mm/4.2mmD (SP)	8661		8662	8663 2.5mm	8664 3.5mm	8665 4.5mm	8625 5.5mm	8626 6.5mm
Internal Hex 5.0mmD (WP)	8671		8672	8673	8674	8675	8627	8628
External SP (Ex Hex)		8681		8682	8683	8684	8685	8696
External WP (Ex Hex)		8820 0.6mm		8821	8822	8823	8824	
Mistral Internal Octagon (Stage One)		8950		8951	8952	8953	8954	8955
SEVEN 3.3 (Internal Connection)	2062 0.1mm		2063	2064	2065	2066	2067	2068
NEOSS								
4.0mmD (Non-Hex)			8451	8452	8453	8454	8455	8456
NEODENT								
Cone Morse				2168	2169	2170	2171	2172
NOBEL BIOCARE / BRANEMARK / STERIOSS								
Active / Conical Connection 3.0mmD			2212	2213	2214	2215	2216	2217
Active / Conical Connection NP (3.5mmD)			2069	2070	2071	2072	2073	2074
Active / Conical Connection RP (4.3mm/5.0mmD)			2075	2076	2077	2078	2079	2080
Steri-Oss Flat-Top 3.8mmD	8651		8652	8653	8654	8655		
Replace Select NP (3.5mmD, Trilobe)	8756		8757	8758	8759	8760	8734	8735
Replace Select RP (4.3mmD, Trilobe)	8761		8762	8763	8764	8765	8753	8754
Replace Select WP (5.0mmD, Trilobe)			8766	8767	8768	8769	8770	
Replace Select 6.0mmD (Trilobe)			8766	8767	8768	8769	8770	
Branemark NP (3.3mmD, Ex Hex)		8105		8106	8107	8108	8109	
Branemark RP (3.75mm/4.0mm/5.0mmD, Ex Hex)		8681		8682	8683	8684	8685	8696
Branemark WP (5.0mmD, Ex Hex)			8825 1.1mm	8826	8827	8828	8829	
Nobel Speedy NP (3.5mmD, Ex Hex)		8105		8106	8107	8108	8109	
Nobel Speedy RP (4.3mmD, Ex Hex)		8681		8682	8683	8684	8685	8696
Replace Ex Hex NP (3.5mmD)			8676	8677	8678	8679	8680	
Replace Ex Hex RP (4.3mmD)			8781	8782	8783	8784	8785	
Replace Ex Hex WP (5.0mmD)			8835 1.37mm	8836	8837	8838	8839	
Hex-Lock (HL) 3.25mmD (Ex Hex)			8646 1.5mm	8647 2.5mm	8648 3.5mm	8649 4.5mm	8650 5.5mm	

LOCATOR® ABUTMENT LISTING CONT'D

IMPLANT ABUTMENT DESCRIPTION

ABUTMENT TISSUE CUFF HEIGHT

	0.0MM	0.73MM	1.0MM	2.0MM	3.0MM	4.0MM	5.0MM	6.0MM
NOBEL BIOCARE / BRANEMARK / STERIOSS cont'd								
Hex-Lock (HL) 3.8mm/4.5mmD (Ex Hex)		8681		8682	8683	8684	8685	8696
Hex-Lock (HL) 5.0mmD (Ex Hex)			8835 1.37mm	8836	8837	8838	8839	
Replace Ex Hex RP (4.3mmD)			8781	8782	8783	8784	8785	
Replace Ex Hex WP (5.0mmD)			8835 1.37mm	8836	8837	8838	8839	
Hex-Lock (HL) 3.25mmD (Ex Hex)			8646 1.5mm	8647 2.5mm	8648 3.5mm	8649 4.5mm	8650 5.5mm	
Hex-Lock (HL) 3.8mm/4.5mmD (Ex Hex)		8681		8682	8683	8684	8685	8696
Hex-Lock (HL) 5.0mmD (Ex Hex)			8835 1.37mm	8836	8837	8838	8839	
OSSTEM / HIOSSEN USA / DENTIS								
SS Internal / HS Regular 4.8mmD		8950		8951	8952	8953	8954	8955
ET/ HG/ GS Mini 3.5mmD (Internal Connection)			1561	1562	1563	1564	1565	1566
ET/ HG/ GS Standard 4.0mmD (Internal Connection)			1551	1552	1553	1554	1555	1556
US Mini 3.3mm / 3.5mmD (Ex Hex)			8105	8106	8107	8108	8109	
US Regular/ HU Regular 3.75mm /4.0mmD (Ex Hex)		8681		8682	8683	8684	8685	8696
OSTEO-IMPLANT CORPORATION								
3.25mm SD, 3.75mm ST, 4.0mm DT		8681		8682	8683	8684	8685	8696
RITTER IMPLANTS								
Advanced RP (Internal Hex)			2284	2285	2286	2287	2288	2289
Spiral/QSI NP (Internal Hex)		2308 0.75mm		2309	2310	2311	2312	2313
SOUTHERN IMPLANT USA								
Tri-Nex 3.5mmD	8756		8757	8758	8759	8760	8734	8735
Tri-Nex 4.3mmD	8761		8762	8763	8764	8765	8753	8754
Tri-Nex 5.0mmD			8766	8767	8768	8769	8770	
Tri-Nex 6.0mmD			8766	8767	8768	8769	8770	
IT 4.8mmD (Internal Octagon)		8950		8951	8952	8953	8954	8955
STERNGOLD IMPLAMED								
Hex Cylinder 3.3mm/4.0mmD		8681		8682	8683	8684	8685	8696
Hex Screw 3.75mm/4.0mmD		8681		8682	8683	8684	8685	8696
STRAUMANN								
Tissue Level 3.5mmD (NP)			2056	2057	2058	2059	2060	2061
Tissue Level 4.8mmD (RP) 2			8742	8743	8744	8745	8751	8752
Tissue Level 6.5mmD (WP)			8870	8871	8872	8873	8874	
Bone Level 3.5mmD (NP)				8422	8423	8424	8425	8426
Bone Level 4.1mmD (RP)			8170	8171	8172	8173	8174	8175

LOCATOR® ABUTMENT LISTING CONT'D

IMPLANT ABUTMENT DESCRIPTION	ABUTMENT TISSUE CUFF HEIGHT							
	0.0MM	0.73MM	1.0MM	2.0MM	3.0MM	4.0MM	5.0MM	6.0MM
SYBRON / INNOVA								
Endopore 3.5mmD (0.9mm Ex Hex)			8851	8852	8853	8854	8855	
Endopore 4.1mmD (0.7mm Ex Hex)		8681		8682	8683	8684	8685	8696
Endopore 5.0mmD (0.9mm Ex Hex)			8691 1.35mm	8692	8693	8694	8695	
Endopore 4.1mm/5.0mmD (One Stage)		8950		8951	8952	8953	8954	8955
Endopore 4.1mmD (Internal Hex)	8145		8146	8147	8148	8149	8150	
Endopore 5.0mmD (Internal Hex)			8164	8165	8166	8167	8168	8169
Entegra 3.25mm/4.0mmD (0.7mm Ex Hex)		8681		8682	8683	8684	8685	8696
Entegra 3.25mmD (0.9mm Ex Hex)			8851	8852	8853	8854	8855	
Entegra 4.7mmD (0.9mm Ex Hex)			8691 1.35mm	8692	8693	8694	8695	
Pitt Easy 3.25mm/3.3mmD			8311	8312	8313	8314	8315	8316
Pitt Easy 3.75mm/3.8mmD			8321	8322	8323	8324	8325	8326
Pitt Easy 4.0mm/4.1mmD			8331	8332	8333	8334	8335	8336
Pitt Easy 4.9mmD			8341	8342	8343	8344	8345	8346
Pro Series XRT Bone Level 3.5mmD			1631	1632	1633	1634	1635	1636
Pro Series XRT Bone Level 4.1mmD			1637	1638	1639	1640	1641	1642
Pro Series XRT Bone Level 4.8mmD		8950		8951	8952	8953	8954	8955
Pro Series Tissue Level (TL) 4.1mm/4.8mmD		8950		8951	8952	8953	8954	8955
Hex Plus 3.5mmD		8105		8106	8107	8108	8109	
Hex Plus 4.1mmD		8681		8682	8683	8684	8685	8696
Hex Plus 5.1mmD			8825 1.1mm	8826	8827	8828	8829	
SARGON								
External Hex 3.8mmD			8722 1.8mm		8723	8724	8725	8726
ZIMMER / CENTERPILSE / CALCITEK / PARAGON								
Advent 3.7mm/4.7mmD (4.5mmD Platform)		8841 0.71mm		8842	8843	8844	8845	8846
Screw-Vent/ Tapered Screw Vent 3.3mm/3.7mm/4.1mmD (3.5mmD)	8661		8662	8663 2.5mm	8664 3.5mm	8665 4.5mm	8625 5.5mm	8626 6.5mm
Screw-Vent / Tapered Screw Vent 4.7mmD (4.5mmD)	8671		8672	8673	8674	8675	8627	8628
Screw-Vent/ Tapered Screw Vent 6.0mm (5.7mmD)			8180	8181	8182	8183	8184	8185
Calcitek: Integral SD 3.25mmD	8611		8612	8613	8614	8615		
Calcitek: Integral 4.0mmD	8651		8652	8653	8654	8655		
Calcitek: Omniloc 3.25mmD	8611		8612	8613	8614	8615		
Calcitek: Omniloc 4.0mmD	8666		8667	8668	8669	8670		
Calcitek: Spline 3.25mmD			8701	8702	8703	8704	8705	
Calcitek: Spline 3.75mm/4.0mmD			8711	8712	8713	8714	8715	

LOCATOR® ABUTMENT LISTING CONT'D

IMPLANT ABUTMENT DESCRIPTION

ABUTMENT TISSUE CUFF HEIGHT

	0.0MM	0.73MM	1.0MM	2.0MM	3.0MM	4.0MM	5.0MM	6.0MM
ZIMMER / CENTERPILOSE / CALCITEK / PARAGON cont'd								
Calcitek: Spline 5.0mmD		8736 0.86mm		8737	8738	8739	8740	
Calcitek: Swede-Vent 4.0mmD (Ex Hex)		8681		8682	8683	8684	8685	8696
Calcitek: Swede-Vent TL (External Hex)		8681		8682	8683	8684	8685	8696
Calcitek: Taperlock (Ex Hex)		8681		8682	8683	8684	8685	8696
Calcitek: Threadlock 4.0mmD (Ex Hex)		8681		8682	8683	8684	8685	8696
Eztetic 3.1mmD			2218	2219	2220	2221	2222	2223
Paragon: Bio-Vent 3.5mmD (3.5mmD Platform)	8661		8662	8663 2.5mm	8664 3.5mm	8665 4.5mm	8625 5.5mm	8626 6.5mm
Paragon: Bio-Vent 4.5mmD (4.5mmD Platform)	8671		8672	8673	8674	8675	8627	8628
Paragon: Core-Vent 4.3mmD (3.5mmD Platform)	8661		8662	8663 2.5mm	8664 3.5mm	8665 4.5mm	8625 5.5mm	8626 6.5mm
Paragon: Core-Vent 5.3mmD (4.5mmD Platform)	8671		8672	8673	8674	8675	8627	8628
Paragon: Micro-Vent 3.25mmD (3.5mmD Platform)	8661		8662	8663 2.5mm	8664 3.5mm	8665 4.5mm	8625 5.5mm	8626 6.5mm
Paragon: Micro-Vent 4.25mmD (4.5mmD Platform)	8671		8672	8673	8674	8675	8627	8628
Paragon: Swiss Plus 3.8mmD			8935	8936	8937	8938		
Paragon: Swiss Plus 4.8mmD		8950		8951	8952	8953	8954	8955

Introducing the brand new LOCATOR R-Tx[®] Removable Attachment System.

- **Increased Pivoting with Angle Correction Up to 30° Per Attachment:** Easier seating that eliminates the need for angled abutments and reduces damage during patient insertion and removal.
- **Improved Abutment Wear Resistance:** 32% harder, 26% more wear resistance, 64% reduction in roughness, and an esthetic gingiva color.
- **More Esthetic and Functional Attachment Housings:** Pink with grooves and flats for improved retention in acrylic, improving esthetics and patient confidence.

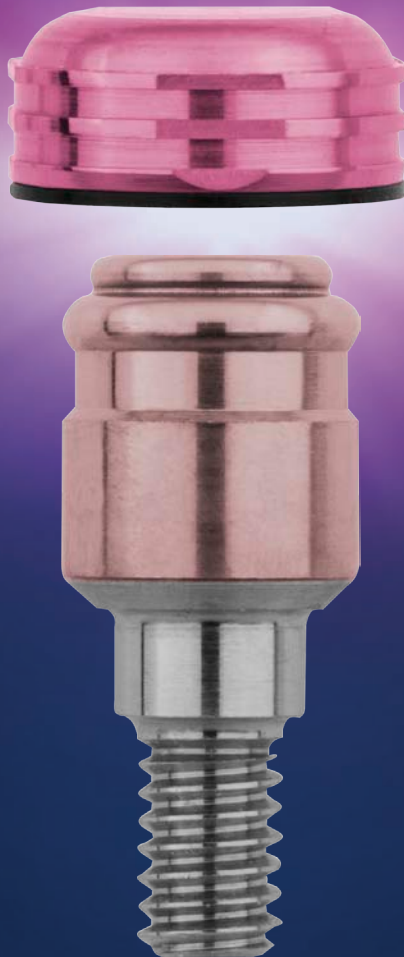

The industry standard for overdenture solutions is now even better—get it first at Preat.

Your Patients Deserve the Best. And So Do You.



The LOCATOR R-Tx[®] Removable Attachment System is available now at **Preat**, backed by expert support from our highly trained technicians and ICOI Masters. *LOCATOR R-Tx is a registered trademark of Zest Anchors, LLC*

Order today at 800.232.7732 or online at Preat.com.

IMPLANT ABUTMENTS/ATTACHMENTS



Locator R-Tx



30001-01



30003-01



30004-01



30013-01



30015-01



30017-01



30021-01

NUMBER	PRODUCT NAME	PRICE
<p>LOCATOR R-Tx®: 2.73mm vertical, 5.45mm Ø, corrects up to 60° of implant divergence, provides an easy self-aligning path of insertion, esthetic pink housings, and new Duratec abutment coating for longer life and greater wear resistance. 2.85mm vertical, 5.55mm Ø</p>		
30001-01	R-Tx Zero Retention Insert (4-Pack)	25.00
30002-01	R-Tx Low Retention Insert (4-Pack)	25.00
30003-01	R-Tx Medium Retention Insert (4-Pack)	25.00
30004-01	R-Tx High Retention Insert (4-Pack)	25.00
30012-01	R-Tx Processing Insert (4-Pack)	25.00
30013-01	R-Tx Denture Attachment Processing Assembly (4-Pack)	60.00
30014-01	R-Tx 3.35mm Abutment Analog (4-Pack) <i>R-Tx analogs for use with narrow diameter implants</i>	75.00
30015-01	R-Tx 4mm Abutment Analog (4-Pack) <i>R-Tx analogs for use with regular platform implants</i>	75.00
30016-01	R-Tx 5mm Abutment Analog (4-Pack) <i>R-Tx analogs for use with wide diameter implants</i>	75.00
30017-01	R-Tx Impression Coping (4-Pack)	75.00
30018-01	R-Tx Processing Spacer (4-Pack)	34.00
30021-01	R-Tx Retention Insert Tool	55.00
4008514	LOCATOR® Block Out Spacer (20-Pack)	20.00
4009665	LOCATOR R-Tx® Patient Education Model	150.00

R-TX ABUTMENT LISTING



ALL R-Tx ABUTMENTS
\$155

R-TX INCLUDES:

- Abutment
- Denture cap
- Spacer
- Four different final retention inserts

IMPLANT ABUTMENT DESCRIPTION

ABUTMENT TISSUE CUFF HEIGHT

	0.5MM	1.0MM	2.0MM	3.0MM	4.0MM	5.0MM	6.0MM
AB DENTAL							
3.75mmD (NP)	30200-00	30200-01	30200-02	30200-03	30200-04	30200-05	30200-06
4.5mmD (WP)	30201-00	30201-01	30201-02	30201-03	30201-04	30201-05	30201-06
ACE							
Bone Level NP		30900-01	30900-02	30900-03	30900-04	30900-05	30900-06
Bone Level RP		30901-01	30901-02	30901-03	30901-04	30901-05	30901-06
Tissue Level RN		31302-01	31302-02	31302-03	31302-04	31302-05	31302-06
BIOHORIZONS							
Internal 3.0mmD		30600-01	30600-02	30600-03	30600-04	30600-05	30600-06
Internal 3.5mm/3.8mmD	30200-00	30200-01	30200-02	30200-03	30200-04	30200-05	30200-06
Internal 4.0mm/4.5mm/4.6mmD	30201-00	30201-01	30201-02	30201-03	30201-04	30201-05	30201-06
Internal 5.7mm/5.8mmD		30202-01	30202-02	30202-03	30202-04	30202-05	30202-06
BIO-LOK							
4.0mm (Ex Hex & Internal Connection)		30306-01	30306-02	30306-03	30306-04	30306-05	30306-06
BIOMET (3i)							
Certain 3.4mmD		30300-01	30300-02	30300-03	30300-04	30300-05	30300-06
Certain 4.1mmD		30301-01	30301-02	30301-03	30301-04	30301-05	30301-06
MicroMiniPlant 3.4mmD (Ex Hex)		30305-01	30305-02	30305-03	30305-04	30305-05	30305-06
MiniPlant 3.75mmD (Ex Hex)		30306-01	30306-02	30306-03	30306-04	30306-05	30306-06
Cylindrical 4.0mmD (Ex Hex)		30306-01	30306-02	30306-03	30306-04	30306-05	30306-06
BLUE SKY BIO							
Certain 3.4mmD		30300-01	30300-02	30300-03	30300-04	30300-05	30300-06
Certain 4.1mmD		30301-01	30301-02	30301-03	30301-04	30301-05	30301-06
MicroMiniPlant 3.4mmD (Ex Hex)		30305-01	30305-02	30305-03	30305-04	30305-05	30305-06
MiniPlant 3.75mmD (Ex Hex)		30306-01	30306-02	30306-03	30306-04	30306-05	30306-06
Cylindrical 4.0mmD (Ex Hex)		30306-01	30306-02	30306-03	30306-04	30306-05	30306-06
One Stage Regular		31302-01	31302-02	31302-03	31302-04	31302-05	31302-06
BTI -BIOTECHNOLOGY INSTITUTE SL							
External Hex 4.1mmD		30306-01	30306-02	30306-03	30306-04	30306-05	30306-06
DENTSPLY / ASTRA							
Ankylos C/X (Conical Connection)			30715-02	30715-03	30715-04	30715-05	30715-06
EV 3.6mmD		30700-01	30700-02	30700-03	30700-04	30700-05	
EV 4.2mmD		30701-01	30701-02	30701-03	30701-04	30701-05	
EV 4.8mmD		30702-01	30702-02	30702-03	30702-04	30702-05	
TX 3.5mm/4.0mmD		30706-01	30706-02	30706-03	30706-04	30706-05	
TX 4.5mm/4.0mmD		30707-01	30707-02	30707-03	30707-04	30707-05	
Frialit-2 / Xive 3.4mmD		30711-01	30711-02	30711-03	30711-04	30711-05	

R-TX ABUTMENT LISTING CONT'D

IMPLANT ABUTMENT DESCRIPTION	ABUTMENT TISSUE CUFF HEIGHT						
	0.5MM	1.0MM	2.0MM	3.0MM	4.0MM	5.0MM	6.0MM
DENTSPLY / ASTRA cont'd							
Frialit-2 / Xive 3.8mmD		30712-01	30712-02	30712-03	30712-04	30712-05	
Frialit-2 / Xive 4.5mmD		30713-01	30713-02	30713-03	30713-04	30713-05	
Frialit-2 / Xive 5.5mmD		30714-01	30714-02	30714-03	30714-04	30714-05	
IMTEC							
Self Tapping 3.75mmD (Ex Hex)		30306-01	30306-02	30306-03	30306-04	30306-05	30306-06
Universal 3.4mm/4.0mmD (Ex Hex)		30306-01	30306-02	30306-03	30306-04	30306-05	30306-06
IMPLANT DIRECT							
Self Tapping 3.75mmD (Ex Hex)		30306-01	30306-02	30306-03	30306-04	30306-05	30306-06
Universal 3.4mm/4.0mmD (Ex Hex)		30306-01	30306-02	30306-03	30306-04	30306-05	30306-06
Legacy 3.5mmD (Internal Hex)	30200-00	30200-01	30200-02	30200-03	30200-04	30200-05	30200-06
Legacy 4.5mmD (Internal Hex)	30201-00	30201-01	30201-02	30201-03	30201-04	30201-05	30201-06
Legacy 5.7mmD (Internal Hex)		30202-01	30202-02	30202-03	30202-04	30202-05	30202-06
RePlus / RePlant / ReActive 3.5mmD (Trilobe NP)	30500-00	30500-01	30500-02	30500-03	30500-04	30500-05	30500-06
RePlus / RePlant / ReActive 4.3mmD (Trilobe RP)	30501-00	30501-01	30501-02	30501-03	30501-04	30501-05	30501-06
RePlus / RePlant / ReActive 5.0mmD (Trilobe WP)		30502-01	30502-02	30502-03	30502-04	30502-05	
SwishTapered / SwishPlus 4.8mmD		31302-01	31302-02	31302-03	31302-04	31302-05	31302-06
IMZ							
3.3mmD (Ex Hex)		30306-01 1.2mm	30306-02	30306-03	30306-04	30306-05	30306-06
4.0mmD (Ex Hex)		30306-01	30306-02	30306-03	30306-04	30306-05	30306-06
INTRA-LOCK SYSTEM INTERNATIONAL							
Threaded 3.75mm/4.0mmD (Ex Hex)		30306-01	30306-02	30306-03	30306-04	30306-05	30306-06
KEYSTONE / LIFECORE BIOMEDICAL							
3.3mm/4.0mmD (Ex Hex)		30306-01	30306-02	30306-03	30306-04	30306-05	30306-06
Stage-1 RegularD		31302-01	31302-02	31302-03	31302-04	31302-05	31302-06
Restore RD 3.75mm/4.0mmD (Ex Hex)		30306-01	30306-02	30306-03	30306-04	30306-05	30306-06
Sustain 4.2mmD (Ex Hex)		30306-01	30306-02	30306-03	30306-04	30306-05	30306-06
TiLobe 3.5/3.8mmD		31200-01	31200-02	31200-03	31200-04	31200-05	31200-06
TiLobe 4.1mmD		31201-01	31201-02	31201-03	31201-04	31201-05	31201-06
TiLobe 5.0/5.5/6.5mmD		31202-01	31202-02	31202-03	31202-04	31202-05	31202-06
MEGAGEN / INTEGRATED DENTAL SYSTEMS							
AnyRidge 3.5mmD (Internatl Connection)		32201-01	32201-02	32201-03	32201-04	32201-05	32201-06

R-TX ABUTMENT LISTING CONT'D

IMPLANT ABUTMENT DESCRIPTION	ABUTMENT TISSUE CUFF HEIGHT						
	0.5MM	1.0MM	2.0MM	3.0MM	4.0MM	5.0MM	6.0MM
MIS - MEDICAL IMPLANT SYSTEM							
Internal Hex 3.75mm/4.2mmD (SP)	30200-00	30200-01	30200-02	30200-03	30200-04	30200-05	30200-06
Internal Hex 5.0mmD (WP)	30201-00	30201-01	30201-02	30201-03	30201-04	30201-05	30201-06
External SP (Ex Hex)		30306-01	30306-02	30306-03	30306-04	30306-05	30306-06
Mistral Internal Octagon (Stage One)		31302-01	31302-02	31302-03	31302-04	31302-05	31302-06
NEODENT							
Cone Morse		32301-01	32301-02	32301-03	32301-04	32301-05	32301-06
NOBEL BIOCARE / BRANEMARK / STERIOSS							
Active / Conical Connection NP		30506-01	30506-02	30506-03	30506-04	30506-05	30506-06
Active / Conical Connection RP		30507-01	30507-02	30507-03	30507-04	30507-05	30507-06
Active / Conical Connection WP		30508-01	30508-02	30508-03	30508-04	30508-05	30508-06
Replace Select NP (3.5mmD, Trilobe)	30500-00	30500-01	30500-02	30500-03	30500-04	30500-05	30500-06
Replace Select RP (4.3mmD, Trilobe)	30501-00	30501-01	30501-02	30501-03	30501-04	30501-05	30501-06
Replace Select WP (5.0mmD, Trilobe)		30502-01	30502-02	30502-03	30502-04	30502-05	
Branemark NP (3.3mmD, Ex Hex)		30510-01	30510-02	30510-03	30510-04	30510-05	30510-06
Branemark RP (3.75mm/4.0mm/5.0mmD, Ex Hex)		30511-01	30511-02	30511-03	30511-04	30511-05	30511-06
Branemark WP (5.0mmD, Ex Hex)		30511-01	30511-02	30511-03	30511-04	30511-05	30511-06
Nobel Speedy NP (3.5mmD, Ex Hex)		30510-01	30510-02	30510-03	30510-04	30510-05	30510-06
Nobel Speedy RP (4.3mmD, Ex Hex)		30511-01	30511-02	30511-03	30511-04	30511-05	30511-06
Replace Ex Hex NP (3.5mmD)		30510-01	30510-02	30510-03	30510-04	30510-05	30510-06
Replace Ex Hex RP (4.3mmD)		30511-01	30511-02	30511-03	30511-04	30511-05	30511-06
Replace Ex Hex WP (5.0mmD)		30512-01	30512-02	30512-03	30512-04	30512-05	
Hex-Lock (HL) 3.8mm/4.5mmD (Ex Hex)		30511-01	30511-02	30511-03	30511-04	30511-05	30511-06
OCO BIOMEDICAL							
3.0mmD		31500-01 0.75mm	31500-02	31500-03	31500-04	31500-05	31500-06
3.5mmD	30200-00	30200-01	30200-02	30200-03	30200-04	30200-05	30200-06
4.5mmD	30201-00	30201-01	30201-02	30201-03	30201-04	30201-05	30201-06
OSSTEM / HIOSSEN USA							
SS Internal / HS Regular 4.8mmD		31302-01	31302-02	31302-03	31302-04	31302-05	31302-06
SS Internal Octagon RP		31606-01 1.5mm	31606-02	31606-03	31606-04	31606-05	31606-06
US Mini 3.3mm / 3.5mmD (Ex Hex)		30510-01	30510-02	30510-03	30510-04	30510-05	30510-06
US Regular/ HU Regular 3.75mm / 4.0mmD (Ex Hex)		30511-01	30511-02	30511-03	30511-04	30511-05	30511-06
OSTEO-IMPLANT CORPORATION							
3.25mm SD, 3.75mm ST, 4.0mm DT		30511-01	30511-02	30511-03	30511-04	30511-05	30511-06
OSTEOREADY							
3.5mmD (Internal Hex)	32401-00	32401-01	32401-02	32401-03	32401-04	32401-05	32401-06

R-TX ABUTMENT LISTING CONT'D

IMPLANT ABUTMENT DESCRIPTION	ABUTMENT TISSUE CUFF HEIGHT						
	0.5MM	1.0MM	2.0MM	3.0MM	4.0MM	5.0MM	6.0MM
SOUTHERN IMPLANT USA							
Tri-Nex 3.5mmD	30500-00	30500-01	30500-02	30500-03	30500-04	30500-05	30500-06
Tri-Nex 4.3mmD	30501-00	30501-01	30501-02	30501-03	30501-04	30501-05	30501-06
Tri-Nex 5.0mmD		30502-01	30502-02	30502-03	30502-04	30502-05	
IT 4.8mmD (Internal Octagon)		31302-01	31302-02	31302-03	31302-04	31302-05	31302-06
STERNGOLD IMPLAMED							
Hex Cylinder 3.3mm/4.0mmD		30511-01	30511-02	30511-03	30511-04	30511-05	30511-06
Hex Screw 3.75mm/4.0mmD		30511-01	30511-02	30511-03	30511-04	30511-05	30511-06
STRAUMANN							
Tissue Level 3.5mmD (NP)		30405-01	30405-02	30405-03	30405-04	30405-05	30405-06
Tissue Level 4.8mmD (RP)		30406-01	30406-02	30406-03	30406-04	30406-05	30406-06
Tissue Level 6.5mmD (WP)		30407-01 1.5mm	30407-02	30407-03	30407-04	30407-05	30407-06
Bone Level 3.5mmD (NP)		30401-01	30401-02	30401-03	30401-04	30401-05	30401-06
Bone Level 4.1mmD (RP)		30402-01	30402-02	30402-03	30402-04	30402-05	30402-06
STRAUMANN							
Endopore 4.1mmD (0.7mm Ex Hex)		30511-01	30511-02	30511-03	30511-04	30511-05	30511-06
Endopore 4.1mm/5.0mmD (One Stage)		31302-01	31302-02	31302-03	31302-04	31302-05	31302-06
Entegra 3.25mm/4.0mmD (0.7mm Ex Hex)		30511-01	30511-02	30511-03	30511-04	30511-05	30511-06
Pro Series XRT Bone Level 4.8mmD		31302-01	31302-02	31302-03	31302-04	31302-05	31302-06
Pro Series Tissue Level (TL) 4.1mm/4.8mmD		31302-01	31302-02	31302-03	31302-04	31302-05	31302-06
Hex Plus 4.1mmD		30511-01	30511-02	30511-03	30511-04	30511-05	30511-06
SYBRON / INNOVA							
Endopore 4.1mmD (0.7mm Ex Hex)		30511-01	30511-02	30511-03	30511-04	30511-05	30511-06
Endopore 4.1mm/5.0mmD (One Stage)		31302-01	31302-02	31302-03	31302-04	31302-05	31302-06
Entegra 3.25mm/4.0mmD (0.7mm Ex Hex)		30511-01	30511-02	30511-03	30511-04	30511-05	30511-06
Pro Series XRT Bone Level 4.8mmD		31302-01	31302-02	31302-03	31302-04	31302-05	31302-06
Pro Series Tissue Level (TL) 4.1mm/4.8mmD		31302-01	31302-02	31302-03	31302-04	31302-05	31302-06
Hex Plus 4.1mmD		30511-01	30511-02	30511-03	30511-04	30511-05	30511-06
ZIMMER / CENTERPULSE / CALCITEK / PARAGON							
Screw-Vent/ Tapered Screw Vent 3.3mm/3.7mm/4.1mm Diameter (3.5mm Diameter)	30200-00 0.5mm	30200-01	30200-02	30200-03	30200-04	30200-05	30200-06
Screw Vent / Tapered Screw Vent 4.7mm Diameter (4.5mm Platform Diameter)	30201-00 0.5mm	30201-01	30201-02	30201-03	30201-04	30201-05	30201-06
Screw-Vent/ Tapered Screw Vent 6.0mm Diameter (5.7mm Platform Diameter)		30202-01	30202-02	30202-03	30202-04	30202-05	30202-06
Calcitek: Swede-Vent 4.0mm Diameter (Ex Hex)		30511-01	30511-02	30511-03	30511-04	30511-05	30511-06
Calcitek: Swede-Vent TL (External Hex)		30511-01	30511-02	30511-03	30511-04	30511-05	30511-06
Calcitek: Taperlock (Ex Hex)		30511-01	30511-02	30511-03	30511-04	30511-05	30511-06

R-TX ABUTMENT LISTING CONT'D

IMPLANT ABUTMENT DESCRIPTION	ABUTMENT TISSUE CUFF HEIGHT						
	0.5MM	1.0MM	2.0MM	3.0MM	4.0MM	5.0MM	6.0MM
ZIMMER / CENTERPULSE / CALCITEK / PARAGON cont'd							
Calcitek: Threadlock 4.0mm (Ex Hex)		30511-01	30511-02	30511-03	30511-04	30511-05	30511-06
Paragon: Bio-Vent 3.5mm Diameter (3.5mm Platform Diameter)	30200-00	30200-01	30200-02	30200-03	30200-04	30200-05	30200-06
Paragon: Bio-Vent 4.5mm Diameter (4.5mm Platform Diameter)	30201-00	30201-01	30201-02	30201-03	30201-04	30201-05	30201-06
Paragon: Core-Vent 4.3mm Diameter (3.5mm Platform Diameter)	30200-00	30200-01	30200-02	30200-03	30200-04	30200-05	30200-06
Paragon: Core-Vent 5.3mm Diameter (4.5mm Platform Diameter)	30201-00	30201-01	30201-02	30201-03	30201-04	30201-05	30201-06
Paragon: Micro-Vent 3.25mm Diameter (3.5mm Platform Dia.)	30200-00	30200-01	30200-02	30200-03	30200-04	30200-05	30200-06
Paragon: Micro-Vent 4.25mm Diameter (4.5mm Platform Dia.)	30201-00	30201-01	30201-02	30201-03	30201-04	30201-05	30201-06
Paragon: Swiss Plus 4.8mm Diameter		31302-01	31302-02	31302-03	31302-04	31302-05	31302-06
Internal 3.5mm/3.8mmD	30200-00	30200-01	30200-02	30200-03	30200-04	30200-05	30200-06
Internal 4.0mm/4.5mm/4.6mmD	30201-00	30201-01	30201-02	30201-03	30201-04	30201-05	30201-06
Internal 5.7mm/5.8mmD		30202-01	30202-02	30202-03	30202-04	30202-05	30202-06
BIO-LOK							
4.0mm (Ex Hex & Internal Connection)		30306-01	30306-02	30306-03	30306-04	30306-05	30306-06
BIOMET (3i)							
Certain 3.4mmD		30300-01	30300-02	30300-03	30300-04	30300-05	30300-06
Certain 4.1mmD		30301-01	30301-02	30301-03	30301-04	30301-05	30301-06
MicroMiniPlant 3.4mmD (Ex Hex)		30305-01	30305-02	30305-03	30305-04	30305-05	30305-06
MiniPlant 3.75mmD (Ex Hex)		30306-01	30306-02	30306-03	30306-04	30306-05	30306-06
Cylindrical 4.0mmD (Ex Hex)		30306-01	30306-02	30306-03	30306-04	30306-05	30306-06
BLUE SKY BIO							
Certain 3.4mmD		30300-01	30300-02	30300-03	30300-04	30300-05	30300-06
Certain 4.1mmD		30301-01	30301-02	30301-03	30301-04	30301-05	30301-06
MicroMiniPlant 3.4mmD (Ex Hex)		30305-01	30305-02	30305-03	30305-04	30305-05	30305-06
MiniPlant 3.75mmD (Ex Hex)		30306-01	30306-02	30306-03	30306-04	30306-05	30306-06
Cylindrical 4.0mmD (Ex Hex)		30306-01	30306-02	30306-03	30306-04	30306-05	30306-06
One Stage Regular		31302-01	31302-02	31302-03	31302-04	31302-05	31302-06
BTI -BIOTECHNOLOGY INSTITUTE SL							
External Hex 4.1mmD		30306-01	30306-02	30306-03	30306-04	30306-05	30306-06
DENTSPLY / ASTRA							
Ankylos C/X (Conical Connection)			30715-02	30715-03	30715-04	30715-05	30715-06
EV 3.6mmD		30700-01	30700-02	30700-03	30700-04	30700-05	
EV 4.2mmD		30701-01	30701-02	30701-03	30701-04	30701-05	
EV 4.8mmD		30702-01	30702-02	30702-03	30702-04	30702-05	
TX 3.5mm/4.0mmD		30706-01	30706-02	30706-03	30706-04	30706-05	
TX 4.5mm/4.0mmD		30707-01	30707-02	30707-03	30707-04	30707-05	
Frialit-2 / Xive 3.4mmD		30711-01	30711-02	30711-03	30711-04	30711-05	

A NEW IMPLANT DESIGNED EXCLUSIVELY FOR OVERDENTURES THE LOCATOR® OVERDENTURE IMPLANT SYSTEM

Until now, choosing a narrow diameter implant often meant a sacrifice in attachment performance and ultimately patient satisfaction. In order to provide patients with the quality of care that they desire, an increasing number of clinicians are now recognizing the unique benefits of using the next generation of narrow diameter implants for retaining overdentures.

The LOCATOR Overdenture Implant System (LODI) comes complete with the world's leading overdenture attachment. LODI has answered clinician requests and patient demands for a less invasive, predictable and cost conscious technique for securing dentures.

The LODI system now allows you to treat patients with the minimum standard of care of an implant supported overdenture,* at a reduced cost and with greater satisfaction.

*The McGill Consensus Statement on Overdentures, Montreal, Quebec, Canada. May 24-25 2002.

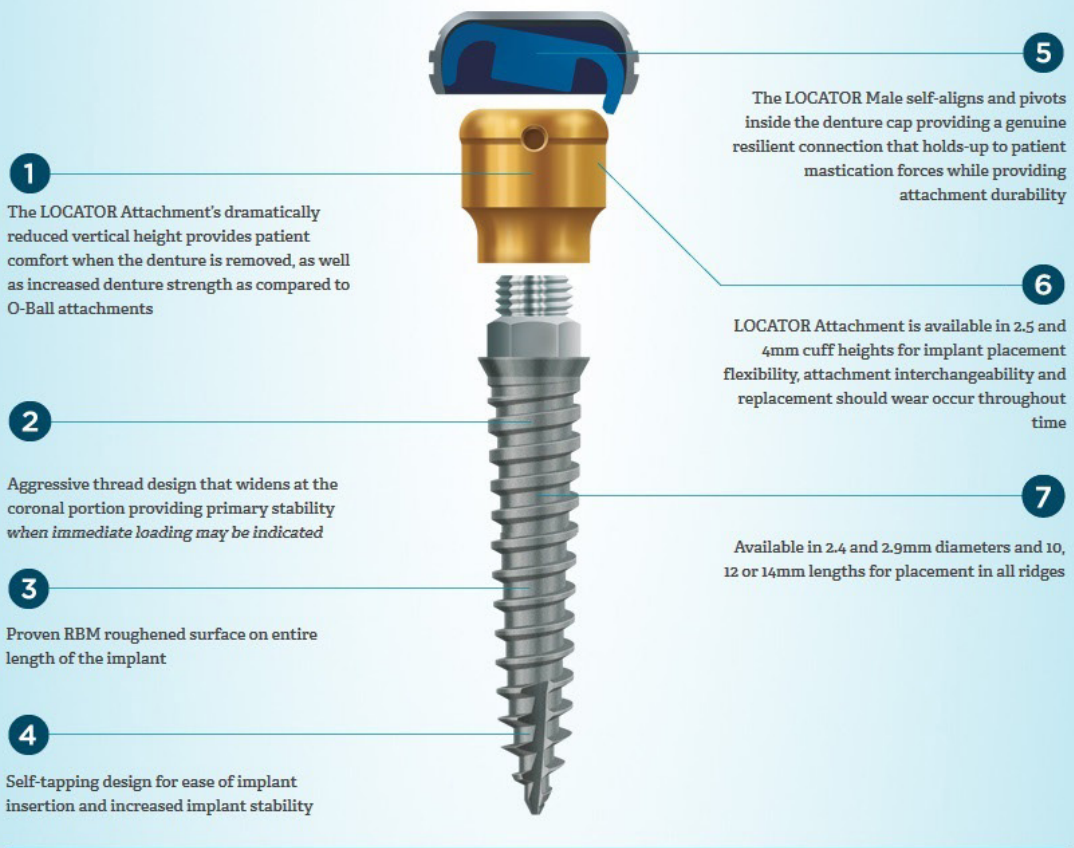
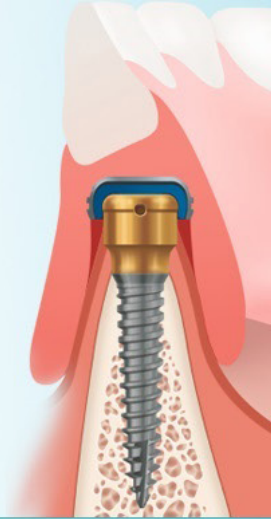

IMPLANT ABUTMENTS/ATTACHMENTS

NUMBER	PRODUCT NAME	PRICE
<p>LOCATOR® Overdenture Implant (LODI): designed to provide a specialty overdenture implant / attachment option where narrow ridges, minimized surgical invasiveness and financial considerations play a role in the implant choice and where a superior overdenture attachment can be utilized with no compromise. The best of both worlds--a narrow diameter implant utilizing the proven LOCATOR® Attachment!</p>		
4007351	LODI Attachment, 2.5mm	46.00
4007352	LODI Attachment, 4mm	46.00
4007365	LODI Direction Indicator	18.00
4007367	LODI Drill 1.6mm	54.00
4007368	LODI Drill 2.1mm	54.00
4007369	LODI Drill 2.6mm	54.00
4007374	LODI Drill Extender	28.00
4007375	LODI Drill 1.8mm	54.00
4007376	LODI Drill 2.4mm	54.00
4007395	LODI Surgical Tray	504.00
4007420	LODI Drill Stops, 6, 8, 10, 12, 14mm	54.00
4007421	LODI Standard Surgical Kit	1099.00
4007422	LODI Premium Surgical Kit	1485.00
4007450	LODI Implant 2.4mm x 10mm, 2.5mm Cuff	164.00
4007451	LODI Implant 2.4mm x 12mm, 2.5mm Cuff	164.00
4007452	LODI Implant 2.4mm x 14mm, 2.5mm Cuff	164.00
4007455	LODI Implant 2.4mm x 10mm, 4.0mm Cuff	164.00



4007351



4007352



4007395



4007422



4007450



4007451



4007452



4007455

IMPLANT ABUTMENTS/ATTACHMENTS



4007456



4007457



4007460



4007461



4007462



4007465



4007466



4007467

NUMBER	PRODUCT NAME	PRICE
4007456	LODI Implant 2.4mm x 12mm, 4.0mm Cuff	164.00
4007457	LODI Implant 2.4mm x 14mm, 4.0mm Cuff	164.00
4007460	LODI Implant 2.9mm x 10mm, 2.5mm Cuff	164.00
4007461	LODI Implant 2.9mm x 12mm, 2.5mm Cuff	164.00
4007462	LODI Implant 2.9mm x 14mm, 2.5mm Cuff	164.00
4007465	LODI Implant 2.9mm x 10mm, 4.0mm Cuff	164.00
4007466	LODI Implant 2.9mm x 12mm, 4.0mm Cuff	164.00
4007467	LODI Implant 2.9mm x 14mm, 4.0mm Cuff	164.00

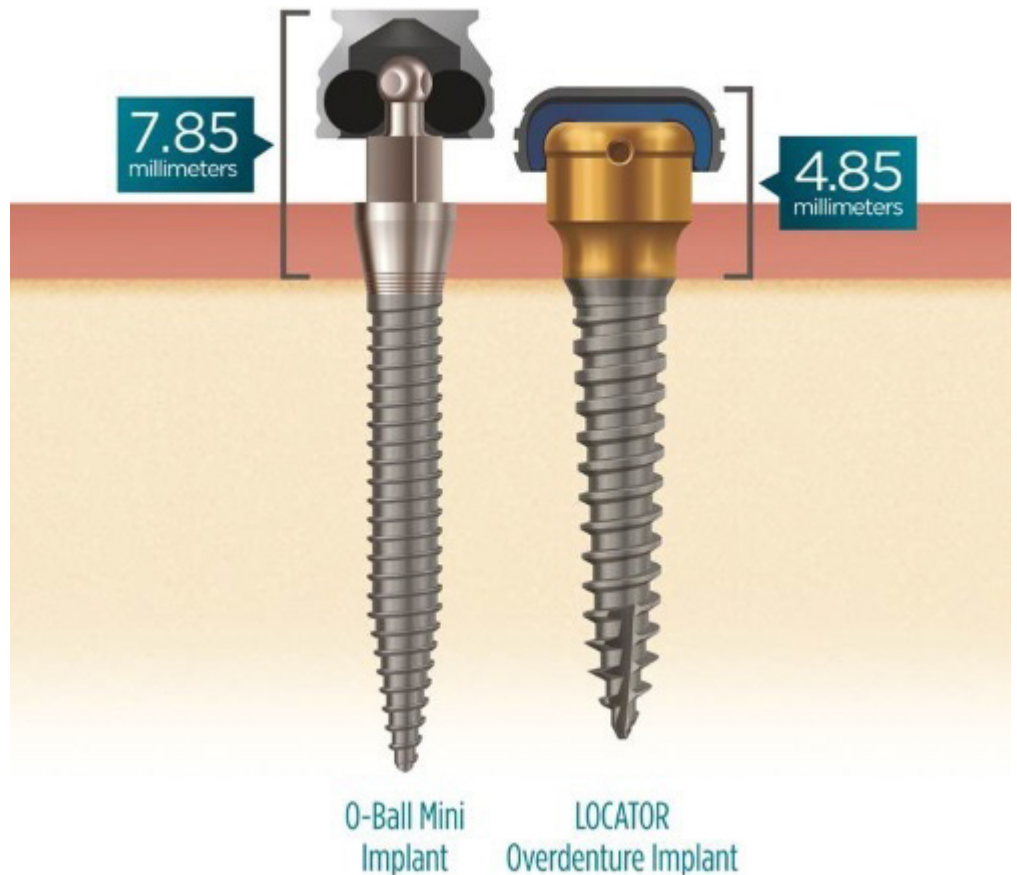

There is a simpler,
more efficient system for FIXED
Full-arch implant restorations.

Welcome to LOCATOR F-Tx[®]

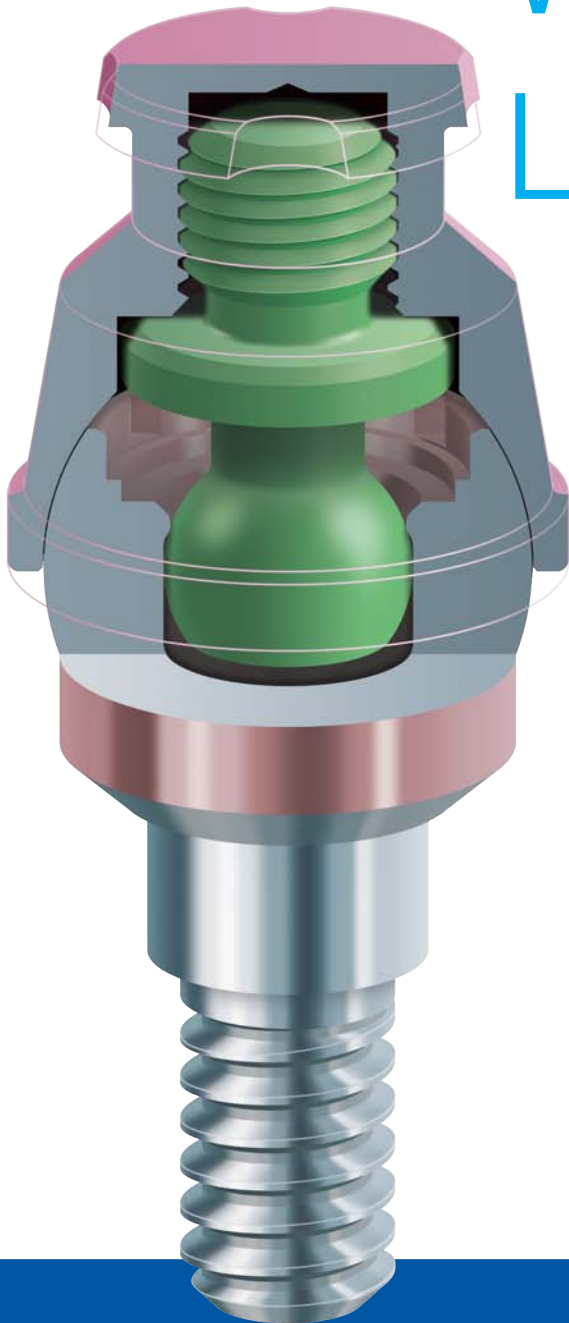

No Screw Holes.

No Cement.

No Problem.

- › Secure snap-fit design
- › Revolutionary prosthesis removal system
- › Unique denture attachment housing
- › All-in-one packaging
- › Simplified angle correction and stress free passive fit
- › Spherical abutment geometry
- › Novel retention balls

IMPLANT ABUTMENTS/ATTACHMENTS



10024



10030



10033



10034



10035



10037



10041



10080

NUMBER	PRODUCT NAME	PRICE
LOCATOR F-Tx® : a revolutionary new solution for FIXED prosthetics. No Screws, No Cement, No Problem!		
10023	F-Tx Attachment System Removal Loop	30.00
10024	F-Tx Attachment System Removal Tool Bar	99.00
10028	F-Tx Attachment System Abutment Driver, Manual	55.00
10029	F-Tx Attachment System Abutment Driver, Latch	55.00
10030	F-Tx Attachment System Processing Cap (2-Pack)	40.00
10032	F-Tx Attachment System Black Processing Ball (2-Pack)	35.00
10033	F-Tx Attachment System Low Retention Ball (Blue) (2-Pack)	35.00
10034	F-Tx Attachment System Medium Retention Ball (Tan) (2-Pack)	35.00
10035	F-Tx Attachment System High Retention Ball (Green) (2-Pack)	35.00
10036	F-Tx Attachment System Healing Cap (2-Pack)	40.00
10037	F-Tx Attachment System Abutment Analog (2-Pack)	40.00
10039	F-Tx Attachment System Polishing Cap (2-Pack)	40.00
10040	F-Tx Attachment System Waxing Cap (2-Pack)	40.00
10041	F-Tx Attachment System Denture Attachment Housing (2-Pack)	80.00
10042	F-Tx Attachment System Retention Ball Hex Driver	55.00
10043	F-Tx Attachment System Impression Coping (2-Pack)	80.00
10044	F-Tx Booster Set, 8mm/6mm/6mm	49.00
10045	F-Tx Attachment System Prosthesis Booster Set, 10mm/8mm/8mm	49.00
10080	F-Tx Attachment System Inflation Device	99.00

F-TX ABUTMENT LISTING



ALL F-Tx ABUTMENTS \$249

R-TX INCLUDES:

- Abutment
- Denture cap
- Spacer
- Three different final retention inserts

IMPLANT ABUTMENT DESCRIPTION	ABUTMENT TISSUE CUFF HEIGHT					
	1.5MM	2.0MM	3.0MM	4.0MM	5.0MM	6.0MM
AB DENTAL						
3.75mmD NP	10200-01	10200-02	10200-03	10200-04	10200-05	10200-06
4.5mmD WP	10201-01	10201-02	10201-03	10201-04	10201-05	10201-06
ACE						
Bone Level NP (Straumann compatible)	10900-01	10900-02	10900-03	10900-04	10900-05	10900-06
Bone Level RP (Straumann compatible)	10901-01	10901-02	10901-03	10901-04	10901-05	10901-06
Tissue Level RN (Straumann compatible)		10906-02	10906-03	10906-04	10906-05	10906-06
BIOHORIZONS						
Internal 3.0mmD		10600-02	10600-03	10600-04	10600-05	10600-06
Internal 3.5mm/3.8mmD	10200-01	10200-02	10200-03	10200-04	10200-05	10200-06
Internal 4.0mm/4.5mm/4.6mmD	10201-01	10201-02	10201-03	10201-04	10201-05	10201-06
BIO-LOK						
4.0mm (Ex Hex & Internal Connection)		10511-02	10511-03	10511-04	10511-05	10511-06
BIOMET (3i)						
Certain 3.4mmD	10300-01	10300-02	10300-03	10300-04	10300-05	10300-06
Certain 4.1mmD	10301-01	10301-02	10301-03	10301-04	10301-05	10301-06
MiniPlant 3.75mmD (Ex Hex)		10511-02	10511-03	10511-04	10511-05	10511-06
Cylindrical 4.0mmD (Ex Hex)		10511-02	10511-03	10511-04	10511-05	10511-06
BLUE SKY BIO						
Internal Hex 3.7mmD	10200-01	10200-02	10200-03	10200-04	10200-05	10200-06
Internal Hex 4.7mmD	10201-01	10201-02	10201-03	10201-04	10201-05	10201-06
Trilobe 3.5mmD (NP)	10500-01	10500-02	10500-03	10500-04	10500-05	10500-06
Trilobe 4.3mmD (RP)	10501-01	10501-02	10501-03	10501-04	10501-05	10501-06
One Stage Regular		10906-02	10906-03	10906-04	10906-05	10906-06
BTI -BIOTECHNOLOGY INSTITUTE SL						
External Hex 4.1mmD		10511-02	10511-03	10511-04	10511-05	10511-06
DENTSPLY / FRIADENT						
Ankylos C/X (Conical Connection)		10715-02	10715-03	10715-04	10715-05	10715-06
EV 3.6mmD	10700-01	10700-02	10700-03	10700-04	10700-05	10700-06
EV 4.2mmD	10701-01	10701-02	10701-03	10701-04	10701-05	10701-06
EV 4.8mmD	10702-01	10702-02	10702-03	10702-04	10702-05	10702-06
TX 3.5mm/4.0mmD (Aqua)	10706-01	10706-02	10706-03	10706-04	10706-05	10706-06
TX 4.5mm/4.0mmD (Lilac)	10707-01	10707-02	10707-03	10707-04	10707-05	10707-06
IMTEC						
Self Tapping 3.75mmD (Ex Hex)		10511-02	10511-03	10511-04	10511-05	10511-06
Universal 3.4mm/4.0mmD (Ex Hex)		10511-02	10511-03	10511-04	10511-05	10511-06

F-TX ABUTMENT LISTING CONT'D

IMPLANT ABUTMENT DESCRIPTION	ABUTMENT TISSUE CUFF HEIGHT					
	1.5MM	2.0MM	3.0MM	4.0MM	5.0MM	6.0MM
IMPLANT DIRECT						
InterActive / SwishActive 3.0mmD (NP)	10506-01	10506-02	10506-03	10506-04	10506-05	10506-06
InterActive / SwishActive 3.4mmD (RP)	10507-01	10507-02	10507-03	10507-04	10507-05	10507-06
Legacy 3.5mmD (Internal Hex)	10200-01	10200-02	10200-03	10200-04	10200-05	10200-06
Legacy 4.5mmD (Internal Hex)	10201-01	10201-02	10201-03	10201-04	10201-05	10201-06
RePlus / RePlant / ReActive 3.5mmD (Trilobe NP)	10500-01	10500-02	10500-03	10500-04	10500-05	10500-06
RePlus / RePlant / ReActive 4.3mmD (Trilobe RP)	10501-01	10501-02	10501-03	10501-04	10501-05	10501-06
SwishTapered / SwishPlus 4.8mmD		10906-02	10906-03	10906-04	10906-05	10906-06
IMZ						
3.3mmD (Ex Hex)		10511-02	10511-03	10511-04	10511-05	10511-06
4.0mmD (Ex Hex)		10511-02	10511-03	10511-04	10511-05	10511-06
INTRA-LOCK SYSTEM INTERNATIONAL						
Threaded 3.75mm/4.0mmD (Ex Hex)		10511-02	10511-03	10511-04	10511-05	10511-06
KEYSTONE / LIFECORE BIOMEDICAL						
3.3mm/4.0mmD (Ex Hex)		10511-02	10511-03	10511-04	10511-05	10511-06
Stage-1 Regular Diameter		10906-02	10906-03	10906-04	10906-05	10906-06
Restore RD 3.75mm/4.0mmD (Ex Hex)		10511-02	10511-03	10511-04	10511-05	10511-06
Sustain 4.2mmD (Ex Hex)		10511-02	10511-03	10511-04	10511-05	10511-06
MEGAGEN / INTEGRATED DENTAL SYSTEMS						
AnyRidge 3.5mmD (Internatl Connection)	12201-01	12201-02	12201-03	12201-04	12201-05	12201-06
MIS - MEDICAL IMPLANT SYSTEM						
Internal Hex 3.75mm/4.2mmD (SP)	10200-01	10200-02	10200-03	10200-04	10200-05	10200-06
Internal Hex 5.0mmD (WP)	10201-01	10201-02	10201-03	10201-04	10201-05	10201-06
External SP (Ex Hex)		10511-02	10511-03	10511-04	10511-05	10511-06
Mistral Internal Octagon (Stage One)		10906-02	10906-03	10906-04	10906-05	10906-06
NEODENT						
Cone Morse		12301-02	12301-03	12301-04	12301-05	12301-06
NOBEL BIOCARE / BRANEMARK / STERIOSS						
Active / Conical Connection NP	10506-01	10506-02	10506-03	10506-04	10506-05	10506-06
Active / Conical Connection RP	10507-01	10507-02	10507-03	10507-04	10507-05	10507-06
Active / Conical Connection WP	10508-01	10508-02	10508-03	10508-04	10508-05	10508-06
Replace Select NP (3.5mmD, Trilobe)	10500-01	10500-02	10500-03	10500-04	10500-05	10500-06
Replace Select RP (4.3mmD, Trilobe)	10501-01	10501-02	10501-03	10501-04	10501-05	10501-06
Replace Select WP (5.0mmD, Trilobe)	10502-01	10502-02	10502-03	10502-04	10502-05	10502-06
Branemark RP (3.75mm/4.0mm/5.0mmD, Ex Hex)		10511-02	10511-03	10511-04	10511-05	10511-06
Nobel Speedy RP (4.3mmD, Ex Hex)		10511-02	10511-03	10511-04	10511-05	10511-06
Replace Ex Hex RP (4.3mmD)		10511-02	10511-03	10511-04	10511-05	10511-06

F-TX ABUTMENT LISTING CONT'D

IMPLANT ABUTMENT DESCRIPTION	ABUTMENT TISSUE CUFF HEIGHT					
	1.5MM	2.0MM	3.0MM	4.0MM	5.0MM	6.0MM
NOBEL BIO CARE / BRANEMARK / STERIOSS cont'd						
Replace Ex Hex RP (4.3mmD)		10511-02	10511-03	10511-04	10511-05	10511-06
Replace Ex Hex WP (5.0mmD)		10512-02	10512-03	10512-04	10512-05	10512-06
Hex-Lock (HL) 3.8mm/4.5mmD (Ex Hex)		10511-02	10511-03	10511-04	10511-05	10511-06
OSSTEM / HIOSSEN USA						
ET Mini Platform (Internal Hex)	11600-01	11600-02	11600-03	11600-04	11600-05	11600-06
ET RP (Internal Hex)	11601-01	11601-02	11601-03	11601-04	11601-05	11601-06
SS RP (Internal Octagon)	11606-01	11606-02	11606-03	11606-04	11606-05	11606-06
SS Internal / HS Regular 4.8mm Diameter		10906-02	10906-03	10906-04	10906-05	10906-06
US Regular/ HU Regular 3.75mm /4.0mm Diameter (Ex Hex)		10511-02	10511-03	10511-04	10511-05	10511-06
OSTEO-IMPLANT CORPORATION						
3.25mm SD, 3.75mm ST, 4.0mm DT		10511-02	10511-03	10511-04	10511-05	10511-06
SYBRON / INNOVA						
Endopore 4.1mm Diameter (0.7mm Ex Hex)		10511-02	10511-03	10511-04	10511-05	10511-06
Endopore 4.1mm/5.0mm Diameter (One Stage)		10906-02	10906-03	10906-04	10906-05	10906-06
Entegra 3.25mm/4.0mm Diameter (0.7mm Ex Hex)		10511-02	10511-03	10511-04	10511-05	10511-06
Pro Series XRT Bone Level 4.8mm Diameter		10906-02	10906-03	10906-04	10906-05	10906-06
Pro Series Tissue Level (TL) 4.1mm/4.8mm Diameter		10906-02	10906-03	10906-04	10906-05	10906-06
Hex Plus 4.1mm Diameter		10511-02	10511-03	10511-04	10511-05	10511-06
SOUTHERN IMPLANT USA						
Tri-Nex 3.5mm Diameter	10500-01	10500-02	10500-03	10500-04	10500-05	10500-06
Tri-Nex 4.3mm Diameter	10501-01	10501-02	10501-03	10501-04	10501-05	10501-06
IT 4.8mm Diameter (Internal Octagon)		10906-02	10906-03	10906-04	10906-05	10906-06
STERNGOLD IMPLAMED						
Hex Cylinder 3.3mm/4.0mm Diameter		10511-02	10511-03	10511-04	10511-05	10511-06
Hex Screw 3.75mm/4.0mm Diameter		10511-02	10511-03	10511-04	10511-05	10511-06
STRAUMANN						
Tissue Level 3.5mmD (NP)		10405-02	10405-03	10405-04	10405-05	10405-06
Tissue Level 4.8mmD (RP)		10406-02	10406-03	10406-04	10406-05	10406-06
Tissue Level 6.5mmD (WP)		10407-02 2.5mm	10407-03	10407-04	10407-05	10407-06
Bone Level 3.5mmD (NP)	10401-01 1.5mm	10401-02	10401-03	10401-04	10401-05	10401-06
Bone Level 4.1mmD (RP)	10402-01 1.5mm	10402-02	10402-03	10402-04	10402-05	10402-06
ZIMMER / CENTERPULSE / CALCITEK / PARAGON						
Screw-Vent/ Tapered Screw Vent 3.3mm/3.7mm/4.1mm Diameter (3.5mm Platform Diameter)	10200-01	10200-02	10200-03	10200-04	10200-05	10200-06
Screw Vent / Tapered Screw Vent 4.7mm Diameter (4.5mm Platform Diameter)	10201-01	10201-02	10201-03	10201-04	10201-05	10201-06

F-TX ABUTMENT LISTING CONT'D

IMPLANT ABUTMENT DESCRIPTION	ABUTMENT TISSUE CUFF HEIGHT					
	1.5MM	2.0MM	3.0MM	4.0MM	5.0MM	6.0MM
ZIMMER / CENTERPULSE / CALCITEK / PARAGON cont'd						
Screw Vent / Tapered Screw Vent 5.7mm (5.5mmD Platform)	10202-01	10202-02	10202-03	10202-04	10202-05	10202-06
Calcitek: Swede-Vent 4.0mm Diameter (External Hex)		10511-02	10511-03	10511-04	10511-05	10511-06
Calcitek: Swede-Vent TL (External Hex)		10511-02	10511-03	10511-04	10511-05	10511-06
Calcitek: Taperlock (External Hex)		10511-02	10511-03	10511-04	10511-05	10511-06
Calcitek: Threadlock 4.0mm (External Hex)		10511-02	10511-03	10511-04	10511-05	10511-06
Paragon: Bio-Vent 3.5mm Diameter (3.5mm Platform Diameter)	10200-01	10200-02	10200-03	10200-04	10200-05	10200-06
Paragon: Bio-Vent 4.5mm Diameter (4.5mm Platform Diameter)	10201-01	10201-02	10201-03	10201-04	10201-05	10201-06
Paragon: Core-Vent 4.3mm Diameter (3.5mm Platform Diameter)	10200-01	10200-02	10200-03	10200-04	10200-05	10200-06
Paragon: Core-Vent 5.3mm Diameter (4.5mm Platform Diameter)	10201-01	10201-02	10201-03	10201-04	10201-05	10201-06
Paragon: Micro-Vent 3.25mmD (3.5mmD Platform)	10200-01	10200-02	10200-03	10200-04	10200-05	10200-06
Paragon: Micro-Vent 4.25mmD (4.5mmD Platform)	10201-01	10201-02	10201-03	10201-04	10201-05	10201-06
Paragon: Swiss Plus 4.8mmD		10906-02	10906-03	10906-04	10906-05	10906-06

IMPLANT ABUTMENTS/ATTACHMENTS

NUMBER	PRODUCT NAME	PRICE
<p>Sphero Flex and Block: a self paralleling ball attachment able to correct up to 15° of divergence between implants.</p>		
0800240	<p>Sphero Flex Implant Abutment <i>Available for nearly all implant systems</i> 4.0mm vertical, 4.8mm Ø 2.5mm ball abutment, Metal Housing, 1 Yellow–1 Pink–1 White Females, blackout spacer, and directional rings</p>	180.00
0800700	<p>Sphero Block 2.5mm Ø Abutment <i>Available for nearly all implant systems</i> 4.0mm vertical, 4.8mm Ø 2.5mm ball abutment, Metal Housing, 1 Yellow–1 Pink–1 White Females, blackout spacer, and directional rings</p>	115.00
0800710	<p>Sphero Block 1.8mm Ø Abutment <i>Available for nearly all implant systems</i> 3.5mm vertical, 4.2mm Ø 1.8mm ball abutment, Metal Housing, 1 Yellow–1 Pink–1 White Females, blackout spacer, and directional rings</p>	115.00
0800161	<p>2.5mm Retention Caps--Light Green (6-Pack) <i>For worn spheres, Rigid Retention (2.2mm)</i></p>	48.00
0800162	<p>2.5mm Retention Caps--Pink (6-Pack) <i>Standard– 1.65lbs</i></p>	48.00
0800163	<p>2.5mm Retention Caps--Green (6-Pack) <i>Soft, gummy for patient comfort</i></p>	48.00
0800164	<p>2.5mm Retention Caps--Yellow (6-Pack) <i>Soft– 1.21lbs</i></p>	48.00
0800166	<p>2.5mm Retention Caps--White (6-Pack) <i>Strong– 2.87lbs</i></p>	48.00
0800167	<p>2.5mm Retention Caps--Orange(6-Pack) <i>For worn spheres, Elastic Retention (2.2mm)</i></p>	48.00

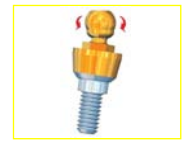

Sphero Flex



Sphero Flex



0800240



0800700



0800710



0800162



0800163



0800164

IMPLANT ABUTMENTS/ATTACHMENTS



0800166



0800167



0800161



0800180

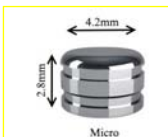

0800280



0800720



0800264



0800262

NUMBER	PRODUCT NAME	PRICE
0800194	Cap Insertion Tool 2.5mm/1.8mm	32.00
0800197	Sphero 2.5mm Analog (2-Pack)	38.00
0800180	2.5mm Stainless Cap Housing (2-Pack)	34.00
0800280	1.8mm Stainless Cap Housing (2-Pack)	34.00
0800720	Sphero 1.8mm Analog (2-Pack)	38.00
0800264	1.8mm Retention Caps--Yellow (6-Pack) ` - Soft - 1.00lbs	48.00
0800262	1.8mm Retention Caps--Pink (6-Pack) - Standard - 1.10lbs	48.00
0800266	1.8mm Retention Caps--White (6-Pack) - Strong - 2.20 lbs	48.00
0800263	1.8mm Retention Caps--Green (6-Pack) <i>Soft, gummy for patient comfort</i>	48.00
0800169	2.5mm Retention Caps--Black (6-Pack) Processing Cap	48.00
0800269	1.8mm Retention Caps--Black (6-Pack) Processing Cap	48.00
0800611	Sphero Flex/Block Driver	80.00
0800267	1.6mm Retention Caps--Orange (6-Pack) <i>For worn spheres, Elastic Retention (1.6mm)</i>	48.00
0800261	1.6mm Retention Caps--Light Green (6-Pack) □ <i>For worn spheres, Rigid Retention (1.6mm)</i>	48.00

IMPLANT ABUTMENTS/ATTACHMENTS

NUMBER	PRODUCT NAME	PRICE
<p>Internal Hex Tube and Screw: used for vertical screw retention of crowns and bridges, fixed prosthesis, implant suprastructures, and telescopic prostheses. All Tube and Screws Include: Tube, countersunk Collar, Fixation screw, and final Hex screw.</p>		
1911702	Hex Tube and Screw 1.2mm Short	99.00
1911703	Hex Tube and Screw 1.4mm Short	99.00
1911802	Hex Tube and Screw 1.2mm Long	99.00
1911803	Hex Tube and Screw 1.4mm Long	99.00
1921732	Hex 1.2mm Tube and Screw Tap	41.00
1921733	Hex 1.4mm Tube and Screw Tap	41.00
1921751	Hex Tube and Screw Socket Key	38.00
1300365	1.6mm Hex Driver (.035)	39.00
1911732	1.2mm Short Screw Only	36.00
1911733	1.4mm Short Screw Only	36.00
1911832	1.2mm Long Screw Only	40.00
1911833	1.4mm Long Screw Only	40.00

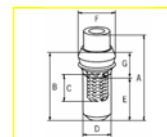

Tube & Screw



1911803



Tube & Screw

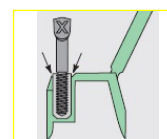

Tube & Screw



Tube & Screw

		A	B	C	D	E	F	G
	Thread	Total length screw/tube	Shortened screw length	Thread length	Sleeve	Sleeve length	Countersunk collar	Countersunk collar
		mm	mm	mm	mm	mm	mm	mm
1.2 short	M1.2	5.20	4.20	1.40	1.80	2.80	2.30	1.50
1.2 long	M1.2	7.20	6.20	3.40	1.80	4.80	2.30	1.50
1.4 short	M1.4	6.20	5.20	1.80	2.00	3.40	2.70	1.90
1.4 long	M1.4	8.10	7.10	3.80	2.00	5.40	2.70	1.90

The demand for partial dentures is expected to grow at 6.8% year to year over the next decade.

REMOVABLE PARTIAL DENTURE ATTACHMENTS

Partner with the company that can help you provide the best patient specific solutions.



AMERICAN MINI

Kennedy Class I semi-precision attachment Mini-Dalbo/Swiss Mini

- 3mm tall, male 2.5mm Ø, female 3.5mm Ø



CEKA REVAX

Kennedy Class I Precision Resilient attachment

- M2 (small): 3.80mm tall, 3.40mm Ø
- M3 (standard): 4.35mm tall, 4.40mm Ø



DSE HINGE

Kennedy Class I



SAGIX

Ideal for Kennedy Class I VKS-SG, OT Strategy, Allegro

- 1.7mm ball: 3.10mm tall, 3.10mm Ø
- 2.2mm ball: 4.10mm tall, 4.20mm Ø



MAYS UNILATERAL

Ideal for Kennedy Class II

- 3mm tall, 2mm Ø



ASC 52

Kennedy Class I

- Mini: 3.15mm tall, 3.15mm Ø
- Standard: 3.40mm tall, 3.40mm Ø



IC ATTACHMENT

Kennedy Class III Hannes Anchor

- male: 5.2mm length, 2mm Ø, 1mm nose.
- female: 2mm Ø, 0.8mm deep



VERTIX

Kennedy Class IV

- 6mm (may be reduced to 3mm) tall, 3.3mm Ø



O-RING DISTAL EXTENSION

Kennedy Class I

- 5.2mm (may be reduced to 2.5mm) tall, 2.00mm Ø



SPHERO RETROFIT

- replacing worn extracoronal attachments, such as the ERA or Ceka
- 1.5mm tall ball, 1.8mm Ø

EXTRACORONAL ATTACHMENTS

NUMBER	PRODUCT NAME	PRICE
<p>Sphero Retrofit Kits: designed to retrofit worn ERA, Ceka, and other worn extracoronar and overdenture attachments Use Ceka Site or metal-to-metal bonding composite. retrofit: 2.7mm* vertical, 4.3mm Ø 2 TiN coated spheres, 1 mandrel/ key, 2 pink females, 2 protector disks. **metal housings 0800280 available separately**</p>		
0800140	Sphero Retrofit Kit	180.00
4007011	ZAAG Retrofit Kit (2-Pack) <i>Retrofit kit for replacing worn extracoronar attachments, such as the ERA or Ceka. Kit of 2 with all necessary components</i>	135.00
<p>Clix Attachment: 2.25mm spherical attachment for partial dentures, overdentures, and implant overdentures. Ideal for 2.25mm ball abutments. The Clix design allows the female to engage all around the ball for an increased area of retention. Besides far greater retention than other spherical systems, the Clix offers the patient security of an audible click. Less wear. Less servicing. Less replacement of worn females.</p>		
0101251	Clix 1251 <i>Plastic castable male and complete female 3.5mm tall, 3.5mm Ø tooth, 4.0mm Ø housing</i>	53.00
01K1251	Clix 1251 Starter Kit (2-Pack) <i>2 1251 attachments, 1 parall. mandrel, 1 insertion tool, 1 cup bur</i>	164.00
0101261	Clix 1261 <i>Precious base ring, threaded male, complete female 4.3mm tall, 4.0mm Ø tooth, 4.0mm Ø housing</i>	118.00
01K1261	Clix 1261 Starter Kit (2-Pack) <i>2 1261 attachments, 1 paralleling mandrel, 1 insertion tool, 1 hex driver, 1 Ceka Bond</i>	366.00
0101271	Clix 1271 <i>4 different Keeper patterns, 1 TI bondable male, complete female 5.5mm tall, 4.0mm Ø tooth, 4.0mm Ø housing</i>	88.00
01K1271	Clix 1271 Starter Kit (2-Pack) <i>2 1271 attachment, Keeper parallel mandrel, Ball parallel mandrel, Ceka Site, 1 insertion tool</i>	366.00



Sphero Retro



ZAAG Retro



Clix

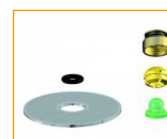

0101251



01k1251



0101261



01k1261



0101271

EXTRACORONAL ATTACHMENTS



01k1271



0101276



01k1276



0101281



01k1281



0101291



0101299



Clix

NUMBER	PRODUCT NAME	PRICE
0101276	Clix 1276 4 different Keeper patterns, 1 TI bondable threaded keeper 1 threaded male, complete female 5.5mm tall, 4.0mm Ø tooth, 4.0mm Ø housing	104.00
01K1276	Clix 1276 Starter Kit (2-Pack) (2) 1276 attachment, threaded parallel mandrel, Hex Driver, Ceka Site, Ceka bond, 1 insertion tool	398.00
0101281	Clix 1281 4 different Keeper patterns, 1 castable male, complete female 5.1mm tall, 3.4mm Ø tooth, 4.0mm Ø housing	78.00
01K1281	Clix 1281 Starter Kit (2-Pack) 2 1281 attachment, Keeper par. mandrel, Cup bur, 1 insertion tool	215.00
0101291	Clix Threaded Post/Ball Complete 1291 Threaded TI post, threaded TI ball, complete female 4.15mm tall, 4.0mm Ø tooth, 4.0mm Ø housing	94.00
0101299	Clix OD DDS Starter Kit 1299 □ (2) 1291 attachments, Clix Bur Set (3), Insertion Tool Hex Driver, Ceka Bond, 2 REH2 Impression Tool, 2 REH14 Analog, Clix female combo pack	360.00
0101293	Clix One piece Ball & Post Complete 1293 One piece TI post and ball, complete female 4.0mm tall, 4.0mm Ø tooth, 4.0mm Ø housing	84.00
0101297	Clix DDS Starter Kit 1297 (2) 1293 attachments, Clix Bur Set (3), Insertion Tool, (2) 1201D analogs, 1 Clix female combo pack	295.00
0101298	Clix Lab Tool Kit Female paralleling Mandrel, Keeper Mandrel, Ball Mandrel, Cup Burr, Insertion Tool	88.00

EXTRACORONAL ATTACHMENTS

NUMBER	PRODUCT NAME	PRICE
0112260	Clix R-Bur set (3-Pack) <i>Set of 3 burs to prepare root for cementation of Clix attachment</i>	82.00
0101291C	Clix Threaded Post Only	36.00
0101293C	Clix One piece Ball & Post Only	60.00
0101274	Universal Threaded Ball 2.2mm <i>Thread: M2 x .040</i> <i>Use with 4009102 and 4009104</i>	40.00
0101224	Preci Ball/Clix Thread Male LONG	49.00
0101238	Preci Ball/Call Hex driver	48.00
01004TI	Clix Male Plastic Keeper Patterns (4-Pack)	60.00
0101220	Preci Ball 22 Castable Male Only	12.00
0101271C	Clix Male TI (bondable male)	40.00
0101281C	Clix Castable Male Pattern	21.00
0112300	Cup Burr (2-Pack) to finish cast spheres	30.00
0101232	Preci Ball/Clix Ball Paralleling Mandrel 3	37.00
0101211	Preci Ball/Clix Female Parallel Mandrel	46.00
0101230	Preci Ball/Clix Analogue (2-Pack)	44.00
0101251B	Clix Space Maintainer (6-Pack)	12.00
011222	Clix Female Insertion Tool	34.00
0101235-6	Clix Metal Housing (6-Pack)	126.00
0101236D-6	Clix Duplicating Female (6-Pack)	52.00



0101293



0101297



0101274



0101238



0101220



0112300



0101271c



0101232

EXTRACORONAL ATTACHMENTS



0101240



0101232W



011222



0101233



0112340



Sagix



0101301



0101303

NUMBER	PRODUCT NAME	PRICE
0101240	Clix Complete Female <i>T1 housing and yellow female</i>	45.00
0101232W-6	Clix White Females- Reduced (6-Pack) <i>white = 1.7lbs retention</i>	36.00
0101232W-50	Clix White Females- Reduced (50-Pack)	200.00
0101231-6	Clix Yellow Females- Standard (6-Pack) <i>yellow = 2.5 lbs retention</i>	36.00
0101231-50	Clix Yellow Females- Standard (50-Pack)	200.00
0101233-6	Clix Red Females - Increased (6-Pack) <i>red = 3.3 lbs retention</i>	36.00
0101233-50	Clix Red Females- Increased (50-Pack)	200.00
0112340	Clix Combi Females <i>2 white, 2 yellow, 2 red Clix Females</i>	36.00

Sagix Attachment: Sagital 1.7 and 2.2mm Ball attachment with female that engages the full sphere for maximum retention. Unique female engages entire sphere for more retention and less attachment wear. Compatible with Bredent VKS-SG 1.7 and 2.2mm balls. 1.7mm: 3.1mm vertical, 3.1mm Ø. 2.2mm: 4.1mm vertical, 4.2mm Ø.

0101301	Sagix Starter Kit Plastic Male (4-Pack) <i>2 1.7mm plastic males, 8 1.7 females (2 white, 2 yellow, 2 red, 2 pink processing), Paralleling Mandrel</i> <i>2 2.2mm plastic males, 8 2.2 females (2 white, 2 yellow, 2 red, 2 pink processing), Sagix Insertion Tool</i> <i>1.7mm: 3.1mm vertical, 3.1mm Ø 2.2mm: 4.1mm vertical, 4.2mm Ø</i>	190.00
0101303	Sagix Starter Kit Cast-to Metal Male (4-Pack) <i>2 1.7mm metal males, 8 1.7 females (2 white, 2 yellow, 2 red, 2 pink processing), Paralleling Mandrel</i> <i>2 2.2mm metal males, 8 2.2 females (2 white, 2 yellow, 2 red, 2 pink processing), Sagix Insertion Tool</i> <i>1.7mm: 3.1mm vertical, 3.1mm Ø 2.2mm: 4.1mm vertical, 4.2mm Ø</i>	285.00

EXTRACORONAL ATTACHMENTS

NUMBER	PRODUCT NAME	PRICE	
0101305	Sagix 1.7 Complete Plastic w/ housing <i>1 plastic male, 1 each yellow, white and red females, 1 processing pink female, 1 metal housing</i>	66.00	 0101305
0101306	Sagix 1.7 Complete Plastic <i>1 plastic male, 1 each yellow, white and red females, 1 processing pink female.</i>	39.00	 0101306
0101356	Sagix 1.7 Complete Metal w/ housing <i>1 metal male, 1 each yellow, white and red females, 1 processing pink female, 1 metal housing</i>	80.00	 0101356
0101357	Sagix 1.7 Complete Metal <i>1 metal male, 1 each yellow, white and red females, 1 processing pink female</i>	53.00	 0101357
0101321	Sagix 1.7 Plastic Castable Male	10.00	 0101321
0101322	Sagix 1.7 Noprax Cast-to Male (2-Pack)	64.00	 0101322
0101325	Sagix 1.7 Metal Housing (2-Pack) CoCr	68.00	 0101325
0101331	Sagix 1.7 Model Analog (2-Pack)	27.00	 0101331
0101316-6	Sagix 1.7 Female Dupl Dummy (6-Pack)	36.00	 0101316-6
0101316-50	Sagix 1.7 Female Dupl Dummy (50-Pack)	200.00	
0101312-6	Sagix 1.7 White Female- Reduced (6-Pack) <i>white = 1.5lbs retention</i>	36.00	
0101312-50	Sagix 1.7 White Female- Reduced (50-Pack)	200.00	
0101311-6	Sagix 1.7 Yellow Female- Standard (6-Pack) <i>yellow = 2.3lbs retention</i>	36.00	
0101311-50	Sagix 1.7 Yellow Female- Standard (50-Pack)	200.00	
0101313-6	Sagix 1.7 Red Female- Increased (6-Pack) <i>red = 3.1lbs retention</i>	36.00	

EXTRACORONAL ATTACHMENTS



0101313



0101314



0101300P



0101323



0101307



0101308



0101358



0101359

NUMBER	PRODUCT NAME	PRICE
0101313-50	Sagix 1.7 Red Female- Increased (50-Pack)	200.00
0101314	Sagix 1.7 Female Combo pack <i>2 white, 2 yellow, 2 red 1.7mm females</i>	36.00
0101300P	Sagix Universal Parallel Mandrel	50.00
0101323	Sagix Universal Insertion Tool	38.00
0101307	Sagix 2.2 Complete Plastic w/ housing <i>1 plastic male, 1 each yellow, white and red females, 1 processing pink female, 1 metal housing.</i>	66.00
0101308	Sagix 2.2 Complete Plastic <i>1 plastic male, 1 each yellow, white and red females, 1 processing pink female</i>	39.00
0101358	Sagix 2.2 Complete Metal w/ housing <i>1 metal male, 1 each yellow, white and red females, 1 processing pink female, 1 metal housing</i>	80.00
0101359	Sagix 2.2 Complete Metal <i>1 metal male, 1 each yellow, white and red females, 1 processing pink female</i>	53.00
0101386	Sagix Complete Threaded Male with Housing <i>1 threaded male, 1 each yellow, white and red females, 1 processing pink female, 1 metal housing</i>	80.00
0101385	Sagix Complete Threaded Male <i>1 threaded male, 1 each yellow, white and red females, 1 processing pink female</i>	55.00
0101371	Sagix 2.2 Plastic Castable Male	10.00
0101372	Sagix 2.2 Noprax Cast-to Male (2-Pack)	64.00
0101373	Sagix 2.2 Threaded Male	42.00

EXTRACORONAL ATTACHMENTS

NUMBER	PRODUCT NAME	PRICE
0101274	Universal Threaded Ball 2.2mm (M2 x .040)	40.00
0101379	Sagix Base Ring Precious 2.2mm	90.00
0101380	Sagix Base Ring Non-Precious 2.2mm	86.00
0101375	Sagix 2.2 Metal Housing (2-Pack) CoCr	68.00
0101381	Sagix 2.2 Model Analog (2-Pack)	27.00
0101366-6	Sagix 2.2 Female Dupl Dummy (6-Pack)	36.00
0101366-50	Sagix 2.2 Female Dupl Dummy (50-Pack)	200.00
0101362-6	Sagix 2.2 White Female- Reduced (6-Pack) white = 1.7lbs retention	36.00
0101362-50	Sagix 2.2 White Female- Reduced (50-Pack)	200.00
0101361-6	Sagix 2.2 Yellow Female- Standard (6-Pack) yellow = 2.5lbs retention	36.00
0101361-50	Sagix 2.2 Yellow Female- Standard (50-Pack)	200.00
0101363-6	Sagix 2.2 Red Female- Increased (6-Pack) red = 3.3lbs retention	36.00
0101363-50	Sagix 2.2 Red Female- Increased (50-Pack)	200.00
0101364	Sagix 2.2 Female Combo pack	36.00



0101274



0101375



0101362



0101361



0101363



0101364

EXTRACORONAL ATTACHMENTS



0101805



0101803



0101840



0101752



0101753



0101754



0101755



0101705

NUMBER	PRODUCT NAME	PRICE
<p>Vertex Attachment: extracoronar slide attachment providing limited resilience and excellent lateral stability and esthetics with castable housing: 3.0mm vertical, 3.3mm Ø with metal housing: 3.0mm vertical, 4.1mm Ø</p>		
0101799	Vertex P Combo Kit (2-Pack) 2 castable P males, 2 castable housings, 1 insertion tool, 1 paralleling mandrel, 6 female riders (2 white, 2 yellow, 2 red)	71.00
0101800	Vertex P Kit (6-Pack) 6 castable P males, 6 yellow female riders, 1 insertion tool, 1 Paralleling Mandrel	83.00
0101801	Vertex Kit (6-Pack) 6 castable males, 6 yellow female riders, 1 insertion tool	83.00
0101805-6	Vertex P Males (6-Pack)	42.00
0101805-50	Vertex P Males (50-Pack)	350.00
0101803-6	Vertex Males (6-Pack) <i>with built in Paralleling Mandrel</i>	42.00
0101803-50	Vertex Males (50-Pack) <i>with built in Paralleling Mandrel</i>	275.00
0101819	Vertex Profile Analogue (2-Pack)	54.00
0101765	Hader White Delrin Analog (2-Pack)	36.00
0101820	Vertex Metal Hood <i>Printed cobalt chrome with SLM retentive surface</i>	27.00
0101820-6	Vertex Metal Hood (6-Pack)	145.00
0101820-12	Preci-Vertex Metal Hood (12-Pack)	260.00
0101840-6	Preci-Vertex Castable Hood (6-Pack)	48.00
0101840-50	Preci Vertex Castable Hood (50-Pack)	312.50
0101752-6	Hader Yellow Riders- Standard (6-Pack)	36.00
0101753-6	Hader White Riders- Reduced (6-Pack)	36.00
0101754-6	Hader Red Riders- Increased (6-Pack)	36.00

EXTRACORONAL ATTACHMENTS

NUMBER	PRODUCT NAME	PRICE
0101755	Hader Combo Pack	36.00
0101705	Hader Insertion Tool	11.00

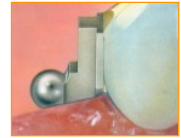

American Mini



Preci 52

American Mini (Mini Dalbo): extracoronal attachment allowing hinge movements with excellent stability
mini: 3.0mm vertical, male 2.5mm Ø, female 3.5mm Ø

1800000	American Mini Complete <i>Stainless Female and Delrin Male</i>	65.00
1800010	American Mini Male only <i>Delrin male may be used as castable pattern (new cases) or as a processing analog (reline, remake, etc)</i>	22.00
1800020	American Mini Female only	45.00



0101551



0101561

Preci 52: resilient, small, universal joint connector allowing vertical and hinge movements. Compatible with
ASC52 mini: 3.15mm vertical, 3.15mm Ø standard: 3.4mm vertical, 3.4mm Ø

0101551	Preci 52 Mini Complete Attachment <i>Ball diameter on mini = 1.55mm</i>	78.00
0101561	Preci 52 Mini Female Only	30.00
0101563	Preci 52 Mini Replacement Male Only	52.00
0101551P	Preci 52 Mini Parallel Mandrel	37.00
0101556	Preci 52 Standard Complete Attachment <i>ball diameter on standard = 1.70mm</i>	78.00
0101566	Preci 52 Standard Female Only	30.00
0101568	Preci 52 Standard Replacement Male Only	52.00
0101556P	Preci 52 Standard Parallel Mandrel	37.00



0101563



0101551P



0101556



0101566

EXTRACORONAL ATTACHMENTS



0101564



0101571



O-Ring



1500150



Mays



IC



IC



DSE Hinge

NUMBER	PRODUCT NAME	PRICE
0101564	Preci 52 Processing Plug (standard & mini)	8.00
0101571	Preci 52 Screw Driver (standard & mini)	90.00

O-Ring Distal Extension: provides free movement in all planes for maximum abutment protection. A proven retentive system utilizing an easily replaceable rubber O ring. Resilient attachment with vertical and hinge stress-breaking action for free-end and bounded partials.

1500150	O-Ring Distal Extension Attachment #3 <i>Burn-out plastic pattern, 3 white o-rings, 1 red o-ring</i>	48.00
1500157	O-Ring Distal Extension Analog #3	24.00
1500153	O-Ring Distal Ext. Paralleling Mandrel #3	18.00
1500502	O-Ring Metal Retainer Standard #3	18.00

Mays Unilateral: designed specifically for the unilateral distal extension. Does not require a lingual or palatal arm. Metal framework is not required; parallelism is not necessary, even on bilateral cases. Requires: 3mm tall, 2mm Ø

0200060	Mays Unilateral Attach UR/LL	154.00
0200061	Mays Unilateral Attach UL/LR	154.00

IC Attachment: a popular spring loaded plunger attachment that provides resilient movement for abutment protection without requiring an abutment crown. The IC attachment requires a 180 degree reciprocal lingual arm if free end. Universal Male: 5.2mm length, 2mm Ø, 1mm nose Universal Female: 2mm Ø, 0.8mm deep

1200112	Universal IC Attachment	62.00
---------	-------------------------	-------

DSE Hinge: bilateral clasp retained free end removable partial dentures designed to reduce loading or torquing of abutments. The unique design provides for easy freeing after casting and provides total lateral stability.

0700006-6	DSE Hinges (6-Pack)	45.00
0700006-12	DSE Hinges (12-Pack)	84.00

EXTRACORONAL ATTACHMENTS

NUMBER	PRODUCT NAME	PRICE
0700006-24	DSE Hinges (24-Pack)	156.00
0700006-100	DSE Hinges (100-Pack)	560.00



Ceka



2R700TI



2R161NP



2R175IR



2R175TI



2R185IR



2R761TI



2R785TI

Ceka and Ceka Revax: adjustable precision attachment allowing vertical, hinge, & rotational movements M2 Revax: 3.8mm vertical, 3.4mmØ M3 Revax: 4.35mm vertical, 4.4mmØ M3 Classic: 3.55mm vertical, 4.3mmØ M2 female attachments only

2R100IR	M2 Red Complete Female IR	72.00
2R100NP	M2 Blue Complete Female NP	72.00
2R100TI	M2 Green Complete Female TI	72.00
2R700TI	M2 Inverted Axial TI	72.00

M2 Complete Extracoronar Attachments

2R161IR	Red M2 Revax Solder IR	126.00
2R161NP	Blue M2 Revax Solder NP	126.00
2R161TI	Green M2 Revax Solder TI	126.00
2R165TI	Green M2 Revax Laser TI	124.00
2R175IR	Red M2 Revax Acrylic IR	126.00
2R175NP	Blue M2 Revax Acrylic NP	126.00
2R175TI	Green M2 Revax Acrylic TI	126.00
2R185IR	Red M2 Revax Spacer IR	126.00
2R185NP	Blue M2 Revax Spacer NP	126.00
2R185TI	Green M2 Revax Spacer TI	126.00

EXTRACORONAL ATTACHMENTS



2R761TI



2RPAX63



2RQ0091



2RP0061



2RP0075



2RP0085



2RP0095



2RQ0031

NUMBER	PRODUCT NAME	PRICE
--------	--------------	-------

Complete M2 Overdenture Attachments

2R761TI	M2 Inverted Axial Solder	126.00
2R785TI	M2 Inverted Axial Spacer	126.00
2R795TI	M2 Inverted Axial Acrylic	126.00
2RPAX61	M2 Axial Pallax Solder	126.00
2RPAX63	M2 Axial Irax Cast-to w/TI	165.00

M2 Axial Overdenture Parts

2RQ0061	M2 Axial Base Ring Pallax	50.00
2RQ0063	M2 Axial Base Ring Irax	94.00
2RQ0091	M2 Axial Female TI	60.00
2RQ0093	M2 Axial Female Irax	92.00

M2 Retention Caps

2RP0061	M2 Pallax Solder Cap (2-Pack)	66.00
2RP0065	M2 TI Laser Caps (2-Pack)	66.00
2RP0075	M2 Acrylic Retention Caps (2-Pack)	66.00
2RP0085	M2 Spacer Retention Caps (2-Pack)	66.00
2RP0095	M2 Axial Acrylic Retention Cap (2-Pack)	66.00

M2 Male Spring Pins

2RQ0031	M2 Spring Pins Standard (2-Pack)	96.00
2RQ0032	M2 Spring Pins 195 (2-Pack)	96.00

EXTRACORONAL ATTACHMENTS

NUMBER	PRODUCT NAME	PRICE
2RQ0033	M2 Spring Pins 202 (2-Pack)	96.00
2RQ031L	M2 Spring Pins Long (2-Pack)	96.00
2RT00H1	M2 Working Spring Pin (2-Pack)	40.00
2RP0096	M2 Space Maintainer	5.00

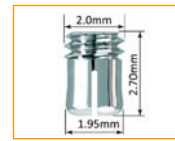

2RQ0032



2RT00H1

M2 Attachment Tools

2RT00A1	A1 Activating Tool & Driver	65.00
2RT00H2	M2 Axial Impression Piece (2-Pack)	58.00
2RT00H4	M2 Axial Solder Accessory (2-Pack)	64.00
2RT00H5	RE H5 Revax Lab Key	64.00
2RT0H10	M2 Spacer Carbide bur	78.00
2RT0H12	M2 Thread Cutter	64.00
2RT0H13	M2 Female Lab Analogue (2-Pack)	63.00
2RT0H14	M2 Impression Tool (2-Pack)	62.00
2RT0H16	M2 Extracoronral Solder Accessory (2-Pack)	66.00
2RT0H20	M2 Spacer Diamond (2-Pack)	64.00
2RT0P25	M2/M3 Universal Paralleling Mandrel	66.00
2RT00P4	M2 Axial/Clix Mandrel	64.00
2RT00P7	Green Revax/Clix Mandrel	30.00



2RT00A1



2RT00H5



2RT0H13



2RT0H14



2RT0H16



2RT00P7

EXTRACORONAL ATTACHMENTS



30200IR



3X0694D



30261IR



30261TI



30275IR



30275NP



30285NP



30285TI

NUMBER	PRODUCT NAME	PRICE
--------	--------------	-------

M3 Female Attachments Only

30200IR	M3 Red Complete Female IR	78.00
30200NP	M3 Blue Complete Female NP	78.00
30200TI	M3 Green Complete Female TI	78.00
30800TI	M3 Inverted Green Female	78.00
3X0694D	OL 694 D Irax Female Bar	108.00
3X0694N	OL 694 D NP Female Bar	108.00

M3 Complete Extracoronol Attachments

30261IR	M3 Revax Red Solder IR	114.00
30261NP	M3 Revax Blue Solder NP	114.00
30261TI	M3 Revax Green Solder TI	114.00
30265TI	M3 Revax Green Laser TI	112.00
30275IR	M3 Revax Red Acrylic IR	114.00
30275NP	M3 Revax Blue Acrylic NP	114.00
30275TI	M3 Revax Green Acrylic TI	114.00
30285IR	M3 Revax Red Spacer IR	114.00
30285NP	M3 Revax Blue Spacer NP	114.00
30285TI	M3 Revax Green Spacer TI	114.00

M3 Classic Complete Extracoronol Attachments

30694KI	Ceka OL 694 KS Irax (2-Pack)	230.00
---------	------------------------------	--------

EXTRACORONAL ATTACHMENTS

NUMBER	PRODUCT NAME	PRICE
30694KN	Ceka OL 694 KS Noprax (2-Pack)	230.00
30694KS	Ceka OL 694 KS Platirax (696 KS PL) (2-Pack)	265.00
30694RI	Ceka OL 694 R Irax	230.00
30694RN	Ceka OL 694 R Noprax (2-Pack)	230.00
30694RX	Ceka OL 694 R Platirax (2-Pack)	265.00
30694SI	Ceka OL 694 S Irax (2-Pack)	230.00
30694SN	Ceka OL 694 S Noprax (2-Pack)	230.00
30694SX	Ceka OL 694 S Platirax (2-Pack)	265.00



30694KN



30694RI



30694SX



30861TI



30895TI



3696P00

Complete M3 Overdenture Attachments

30861TI	M3 Invert Axial Solder TI	114.00
30885TI	M3 Invert Axial Spacer TI	114.00
30895TI	M3 Invert Axial Acrylic TI	114.00
3693I00	M3 691 Axial PA/TI	114.00
3696P00	M3 693 Axial IR/TI	162.00

M3 Axial Overdenture Parts

3X691AP	691 A Axial Female Titanium	56.00
3X691DP	691 D Pallax Base Ring	48.00
3X693AI	693 A Axial Female Irax	80.00
3X693DI	693 D Irax Base Ring	92.00



3X691AP



3X691DP

EXTRACORONAL ATTACHMENTS



3X694C2



3694C19



3694C20



3694C29

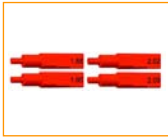

3694CL8



3TL03H1



3694KS2



3X694AR

NUMBER	PRODUCT NAME	PRICE
M3 Male Spring Pins		
3X694C2	M3 694C Standard Spring Pin (2-Pack)	96.00
3694C19	M3 694C Spring Pin 195 (2-Pack)	96.00
3694C20	M3 694C Spring Pin 202 (2-Pack)	96.00
3694C29	M3 694C Spring Pin 209 (2-Pack)	96.00
3694CL0	M3 694C Spring Pin Long (2-Pack)	96.00
3X724C2	M3 724 C Rigid Pin (2-Pack)	76.00
3694CL8	Ceka Sizer	35.00
3TL03H1	M3 Working Dummy Pin (2-Pack)	40.00
3X694B0	M3 Space Maintainer 694B	5.00

M3 Retention Caps		
3694KS2	M3 Acrylic Retention Cap (2-Pack) 694 AKS	66.00
3X694A2	M3 Solder Retention Cap (2-Pack) 694 AS	66.00
3X694AL	M3 TI Laser Caps (2-Pack) 694 AL	66.00
3X694AR	M3 Spacer Retention Cap (2-Pack) 694 AR	66.00
3X6AKS2	M3 694 AKS2 Acrylic Retention (2-Pack)	66.00

M3 Attachment Tools		
3TL00H2	M3 Axial Impression Tool (2-Pack)	58.00
3TL00H4	M3 Axial Soldering Tool (2-Pack)	64.00
3TL0H14	M3 Impression Tool (2-Pack) H14	58.00

EXTRACORONAL ATTACHMENTS

NUMBER	PRODUCT NAME	PRICE
3TLOH16	M3 Extracoronol soldering accessory (2-Pack)	66.00
3TLH13	M3 Female Lab Analogue (2-Pack) H13	63.00
3TLP700	M3 Green Keeper Paralleling Mandrel	30.00
3Z20000	Ceka Site <i>Anaerobic metal-to-metal bonding composite</i>	124.00
3Z1000	Ceka Bond <i>Non-water soluble dental thread locker</i> <i>Great for implant abutments, screws, and ortho appliances</i>	37.00
3Z1000-3	Ceka Bond (3-Units)	90.00
3Z1000-12	Ceka Bond (12-Units)	300.00



3TLH13



3Z20000



3Z1000



0808698



0808699



0805056



0805055



0804400

CSA (Strategy): 1.8mm Castable Resilient Spherical Attachment for extracoronol partial dentures and overdenture bars. standard male: 3.0mm vertical, 4.3mm Ø high male: 3.1mm vertical, 4.3mm Ø

0808698	CSA Standard Male Starter Kit (2-Pack) 2 complete Standard Male attachments, 1 Paralleling Mandrel, 1 Insertion Tool	136.00
0808699	CSA High Male Starter Kit (2-Pack) 2 complete High Male attachments, 1 Paralleling Mandrel, 1 Insertion Tool	136.00
0805056	CSA Standard Male Complete 1 standard male, 1 metal housing, 2 white females and 1 yellow female	62.00
0805055	CSA High Male Complete 1 high male, 1 metal housing, 2 white females and 1 yellow female	62.00
0800805	CSA Laser Male (2-Pack) TI	115.00
0804400	CSA Processing Analog (2-Pack)	50.00

EXTRACORONAL ATTACHMENTS



0807500



0808610



0804501



0804502



0804500



0804505



0805054



0805154

NUMBER	PRODUCT NAME	PRICE
0804600	CSA Stainless Steel Housing (2-Pack)	38.00
0807500	CSA Paralleling Mandrel	27.00
0808610	CSA Cap Insertion Tool	27.00
0804501-4	CSA Yellow Caps- Proc./Soft Retention (4-Pack)	36.00
0804502-4	CSA Pink Caps- Standard Retention (4-Pack)	36.00
0804500-4	CSA White Caps- High Retention (4-Pack)	36.00
0804505-4	CSA Light Green Caps- Strong Retention (4-Pack)	36.00
0805054-4	CSA High Male (4-Pack)	32.00
0805154-4	CSA Standard Male (4-Pack)	32.00

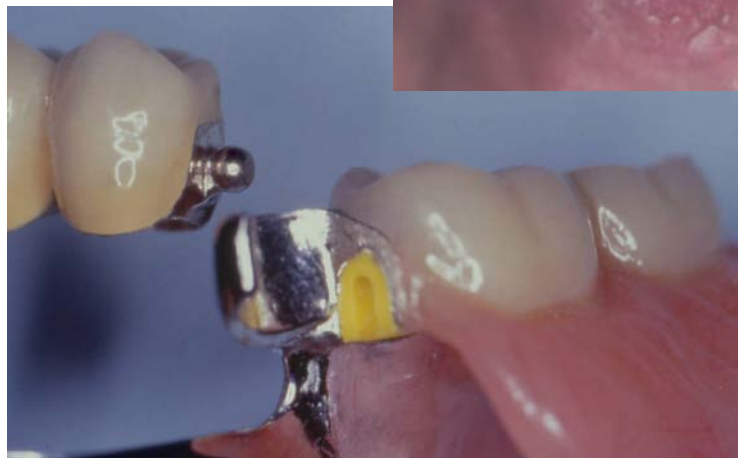

CROWN & BRIDGE SPECIALTY

NUMBER	PRODUCT NAME	PRICE
<p>Splintastik: a very simple plastic male and female rod and tube for use in anterior segmented bridgework. The female features a smooth ceramic insert to assure accurate castings. Small 0.8mm diameter Large 1.2mm diameter.</p>		
0200001	Splintastik Starter Kit <i>2 each: Large Male, Female, and ceramic insert</i> <i>2 each: Small Male, Female, and ceramic insert</i> <i>1 each: Small and Large Mandrels, and Precision Reamers</i>	66.00
0200002	Splintastik Refill SM (6-Pack) <i>Small Male, Female, and Ceramic insert, size 0.8mm Ø</i>	60.00
0200003	Splintastik Refill LG (6-Pack) <i>Large Male, Female, and Ceramic insert, size 1.2mm Ø</i>	60.00
0200004	Splintastik Small Reamer	10.00
0200005	Splintastik Large Reamer	10.00
0200006	Splintastik Small Paralleling Mandrel	7.00
0200007	Splintastik Large Ceramic Insert	7.00
0200008	Splintastik Small Ceramic Insert	7.00
0200009	Splintastik Large Paralleling Mandrel	7.00



Splintastik



0200001



200003



200005



200007

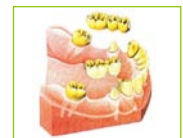

BPD

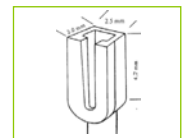

BPD Female



BPD Male

Better Plastic Dovetail (BPD): precision stress breaker ideal for posterior bridges as well as Intracoronal semi-precision slide attachment. Rigid attachment (always use a retentive clasp arm) with friction (not adjustable) retention. Ideal for nonparallel abutments and segmented units. Inside of female rounded to facilitate devesting and avoid attachment wear. Built in paralleling mandrels for both male and female.

0200040-6	BPD (Better Plastic Dovetail) (6-Pack)	30.00
0200040-12	BPD (Better Plastic Dovetail) (12-Pack)	54.00
0200040-50	BPD (Better Plastic Dovetail) (50-Pack)	200.00

CROWN & BRIDGE SPECIALTY

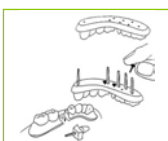

Pozi



0200020



Preci Post



Preci Post



Preci Post



0102001



0102005



01012006

NUMBER	PRODUCT NAME	PRICE
0200040-100	BPD (Better Plastic Dovetail) (100-Pack)	350.00
0200020	Pozi Pins (1000-Pack) <i>Pozi Pins are an inexpensive, easy way to work with twin dowel pin systems. The Pin has a taper for easy seating and removal while reducing wear, micro ribs to provide excellent retention even after multiple removals, and the top has a flat head to save space and prevent rotation.</i>	20.00
0200020-5	Pozi Pins 1000 (5-Pack)	85.00
0200020-10	Pozi Pins 1000 (10-Pack)	140.00
0200020-25	Pozi Pins 1000 (25-Pack)	225.00

Preci Post: a simplified color coded system of tapered reamers, impression posts, and burn out posts for cast endodontic post restorations. A great communication tool between Dentist and Lab.

0102001	Preci Post Kit <i>25 yellow DDS, 25 yellow Lab, 25 blue DDS, 25 blue Lab, Yellow Reamer, Blue Reamer</i>	104.00
0102002	Preci Post DDS refill <i>50 Yellow: 14.4mm length, 0.8mm tip diameter 50 Blue: 16.97mm length, 1.0mm tip diameter</i>	54.00
0102003	Preci Post Lab refill <i>50 Yellow: 14.5mm length, 0.8mm tip diameter 50 Blue: 16.82mm length, 1.0mm tip diameter</i>	52.00
0102005	Preci Post Reamer Yellow	36.00
0102006	Preci Post Reamer Blue	36.00
0101400	Preci Profile Straight 50mm	52.00

CROWN & BRIDGE SPECIALTY

NUMBER	PRODUCT NAME	PRICE
0101410	Preci Profile Curved 50mm <i>Height: 2.9mm Length: 50mm Width: 2.0mm Vickers Hardness: 210</i>	52.00
1100001	Fiberglass Pencil <i>Ideal for removal of oxidation from castings and pre-cleaning of solder joint areas. Always use these pencils in front of a suction or vacuum system</i>	30.00
1100003	Fiberglass Pencil Refill	12.00
1100004	Brass Brush Pencil <i>Intended for the removal of investment from small, difficult to reach areas. Always use these pencils in front of a suction or vacuum system</i>	30.00
1100005	Brass Brush Pencil Refill	12.00

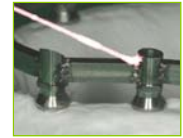

Preci Profile



Preci Profile



1100001



1100004



FR Attachment



FR Attachment



FR Attachment



0702000

FR Attachment: Intracoronar, Extracoronar, or Segmented Bridgework Precision stress breaker ideal for bridges as well as partial dentures. Male fabricated from CoCr

0702000	FR Intro Kit (6 attachments) <i>4 Self Cure Males, 2 Direct Cast Males, 6 females, 4 Silicone Males, 1 Center Punch, 1 Male Mandrel, 1 Female Mandrel</i>	230.00
0702010	FR Self Cure Complete <i>Self Cure Male with Plastic Female</i>	27.00
0702020	FR Direct Cast Complete <i>Direct Cast Male, Casting Sleeve, Plastic Female</i>	27.00
0702030	FR Female Only	9.00

CROWN & BRIDGE SPECIALTY

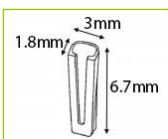

0702030



0702040



0702070



0702071



Pin Screw



1300300



1300320



1300333

NUMBER	PRODUCT NAME	PRICE
0702040	FR Silicone Male	9.00
0702050	FR Male Parallel Mandrel	22.00
0702060	FR Female Parallel Mandrel	22.00
0702070	FR Slotted Center Punch	75.00
0702071	FR Punch Tip Only	22.00
0702010-12	FR Self Cure Complete (12-Pack)	246.00
0702010-6	FR Self Cure Complete (6-Pack)	150.00
0702020-12	FR Direct Cast Complete (12-Pack)	246.00
0702020-6	FR Direct Cast Complete (6-Pack)	150.00
0702040-6	FR Silicone Male (6-Pack)	48.00
0702040-12	FR Silicone Male (12-Pack)	84.00

Internal Hex Pin Screw: set screw or locking screw for horizontal dentist-only removable crown, bridge, or removable prosthesis over implant suprastructures or telescopic castings.

1300300	Pin Screw 1.6mm Master Kit (6-Pack) <i>Contents Include: (6-Pack) 1.60mm Hex Pin Screws, (1) 1.20mm Center Drill, (1) 1.40mm Twist Drill, (2-Pack) 1.60mm Thread Cutter, (1) Socket Key, (1) Hex driver (0.35mm)</i>	455.00
1300320	Pin Screw 1.6mm Starter Kit (3-Pack) <i>Contents Include: (3) 1.60mm Hex Pin Screws, (1) 1.20mm Center Drill, (1) 1.40mm Twist Drill, (1) 1.60mm Thread Cutter, (1) Socket Key, (1) Hex driver (0.35mm)</i>	280.00
1300333	Pin Screw 1.6mm Internal Hex	49.00
1300340	Pin Screw 1.0mm Center Drill	13.00

CROWN & BRIDGE SPECIALTY

NUMBER	PRODUCT NAME	PRICE
1300342	Pin Screw 1.2mm Center drill	13.00
1300344	Pin Screw 1.4mm Center Drill	13.00
1300346	Pin Screw 1.2mm Twist drill	17.00
1300348	Pin Screw 1.4mm Twist drill	17.00
1300350	Pin Screw 1.4mm Thread Cutter	41.00
1300352	Pin Screw 1.6mm Thread Cutter	41.00
1300360	Pin Screw Socket Key	39.00
1300365	1.6mm Hex Driver (.035)	39.00



1300342



1300344



1300346



1300348



1300350



1300352



0702010

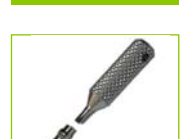

0702020

NEW

TriLor **HIGH PERFORMANCE POLYMER**

- **LIGHTWEIGHT AND ESTHETIC**
- **FULL COVALENT BOND**
- **TIME AND COST SAVINGS**



TriLor has improved workflow in my laboratory and chairside while still achieving a very esthetic outcome.

—EUGENE ROYZENGURT, Owner of Apple Dental Lab

Predictable outcome is predictable income. I use TriLor as a tool to make my implant retained cases predictable.

—JEREMY WOHLERS, CDT, Owner of Esthetics in Function Dental Lab

It's your choice

Fabricated at the bench in **under 30 minutes with a handpiece!**

DIGITAL
TRILOR 98 AND 95
CAD CAM PUCKS



16mm, 20mm or 25mm

ANALOG
TRILOR ARCH
3 DIFFERENT THICKNESSES



NUMBER	PRODUCT NAME	PRICE
<p>TriLor® is a millable fiber-reinforced resin material designed for suprastructures for full arch restorations and bridge frameworks. This super-strong resin flexes and bends under stress, transferring less energy to the implants, making it an ideal support material for implant restorations. The TriLor® Arch uniquely allows the Dental Professional to design the framework using a lathe or handpiece. CAD/CAM TriLor® Pucks are also available.</p>		
50000-35	TriLor® Arch, 3.5mm (3-Pack)	259.95
50000-55	TriLor® Arch, 5.5mm (3-Pack)	279.95
50000-75	TriLor® Arch, 7.5mm (3-Pack)	299.95
50000-16	TriLor® 98 CAD Puck, 16mm	249.95
50000-20	TriLor® 98 CAD/CAM Puck, 20mm	259.95
50000-25	TriLor® 98 CAD/CAM Puck, 25mm	299.95
50005-16	TriLor® 95 CAD/CAM Puck, 16mm	249.95
50005-20	TriLor® 95 CAD/CAM Puck, 20mm	259.95
50005-25	TriLor® 95 CAD/CAM Puck, 25mm	299.95



3.5mm Arch



5.5mm Arch



7.5mm Arch



Arch Model



TriLor



TriLor



TriLor 95 Puck



TriLor 98 Puck

TriLor HIGH PERFORMANCE POLYMER

TRILOR INDICAITONS FOR SUPRASTRUCTURE DESIGN

- A. Minimum must be 7mm² (3.5mm x 2mm)
- B. Minimum thickness around cylinders is 0.8mm
- C. Maximum cantilever is 10mm

TRILOR MATERIAL COMPARISON

Properties	TriLor®	Trinia™	PEKKTON®	JUVORA® PEEK	Zirconia + Ittrio	CrCo
Tensile Strength	380 MPa	169 MPa	115 MPa	100 MPa	348 MPa	695 MPa
Flexural Strength	540 MPa	393 MPa	200 MPa	170 MPa	1200 MPa	600 MPa
Tensile Elongation	2%	2.7%	4.4%	20%	–	8%
Flexural Modulus	26 GPa	18.8 GPa	5.0 GPa	4.0 GPa	210 GPa	175 GPa
Compressive Strength	530 MPa	347 MPa	246 MPa	118 MPa	2000 MPa	448 MPa

YOUR RESTORATION IS YOUR REPUTATION



FEATURES OF THE EFIBER AND MESH STARTER KIT

- Translucent for maximum esthetics and optimal positioning
- Easy to adjust, grind and polish
- Bis-GMA and PMMA impregnated e-glass fibers
- Use with all composite and acrylic resins
- Easy to handle—improve productivity
- No special tools needed



Fiber Space Maintainer

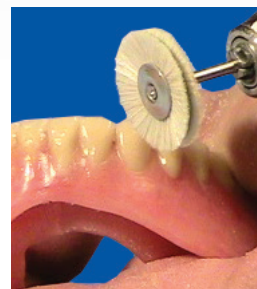

In Office Repairs



Intra Oral Splinting



New Case / Superdenture



Mesh Denture Repair

WE OFFER FREE TECH VIDEOS



Single Tooth Provisional

STEP 1



Reinforced Overdenture Attachments



eFiber Denture Repair



STEP 2

FIBER TECHNOLOGY

NUMBER	PRODUCT NAME	PRICE
<p>eFiber and Mesh: BisGMA and PMMA impregnated E-glass fibers. Use fiber to prevent Stress Cracks from starting before they begin. Increase fatigue resistance. Increase flexural strength. Improve Esthetics--the fibers are translucent; no ugly metal wires. Happy patients--eliminate broken prostheses and non-revenue chairside time. Easy to grind and finish-stop breakage before it begins. Bonds to all composite and acrylic resins. Easy to handle; no special tools needed--Improve productivity</p>		
7009050	<p>eFiber Starter Kit</p> <p>45cm of Perma Mesh, 10cm eFiber 1.6mm, 10cm eFiber 1.2mm, Bonding Adhesive (white bottle), Wetting Agent (black bottle)</p> <p>Flowable Composite with extra tips, Goats Hair Polishing Wheel, 244 Blue Polishing Paste, F8 Silicone Cutter/Polisher</p> <p><i>The Dentist's Must Have Toolbox!</i></p>	325.00
7009052	<p>eFiber Perio Kit</p> <p>(2-Pack) 10cm units of eFiber 1.2mm, (1) silicone tool, an instructional DVD, and user instructions</p>	170.00
7009055	<p>eFiber Ortho Kit</p> <p>(2-Pack) 10cm units of eFiber 1.2mm, (1) 2mL syringe of flowable composite, (1) silicone tool, an instructional DVD, and user instructions</p>	180.00
7009060	<p>eFiber 1.2mm</p> <p>10 cm long narrow diameter translucent polishable e-glass fiber for direct bonded ortho and perio splints</p>	92.00
7009060-2	eFiber 1.2mm (2 units)	170.00
7009060-3	eFiber 1.2mm (3 units)	225.00
7009060-5	eFiber 1.2mm (5 units)	350.00
7009060-10	eFiber 1.2mm(10 units)	575.00
7009070	<p>eFiber 1.6mm</p> <p>10 cm long wider diameter translucent polishable e-glass fiber for reinforced dentures, repairs, Maryland bridges, and more!</p>	92.00



Fiber Splint



Fiber Denture



7009050



Fiber Ortho



Maryland Bridge



Space Maintainer



7009060



eFiber & Mesh

FIBER TECHNOLOGY



eFiber & Mesh



New Fiber Denture



New Fiber Denture

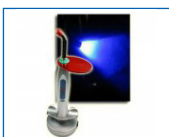

7009080



7009011

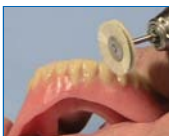

Perma Mesh



Perma Mesh



7009012

NUMBER	PRODUCT NAME	PRICE
7009070-2	eFiber 1.6mm (2 units)	170.00
7009070-3	eFiber 1.6mm (3 units)	225.00
7009070-5	eFiber 1.6mm (5 units)	350.00
7009070-10	eFiber 1.6mm (10 units)	575.00
7009030	Bonding Agent 5ml	38.00
7009035	Wetting Agent 5ml	38.00
7009040	Easy Flowable Composite 2ml	38.00
7009071	Stepper Tool	24.00
7009072	Placement Tool	24.00
7009080	Hand Held Curing Light	90.00
7009011	Perma Mesh (45cm) <i>Pmma-impregnated polishable multi-directional e-glass mesh ideal for repairs and reinforcement</i>	100.00
7009011-2	Perma Mesh (2 Units)	180.00
7009011-6	Perma Mesh (6 Units)	480.00
7009011-12	Perma Mesh (12 Units)	780.00
7009010	PREAT Perma Fiber <i>Pmma-impregnated e-glass fiber. Technique sensitive. We recommend 2nd Generation eFiber</i>	100.00
7009010-3	PREAT Perma Fiber	270.00
7009012	Perma Fiber/Mesh Intro Kit <i>One stick of Perma Fiber and one sheet of Perma Mesh</i>	190.00
7009006	Everstick Intro Kit □ 1 x 5 cm Everstick C&B, 1 x 5cm Everstick Perio	240.00

Attachments
FIBER TECHNOLOGY

NUMBER	PRODUCT NAME	PRICE
7009004	Everstick Ortho (2-Pack) • 2 x 12cm Everstick Ortho 0.75mm	365.00
7009005	Everstick C&B (2-Pack) • 2 x 12cm Everstick C&B 1.6mm	365.00
7009007	Everstick Perio Kit (2-Pack) • 2 x 12cm Everstick Perio 1.2mm	365.00
7009008	Everstick Mesh	365.00



70090630



7009035



7009040

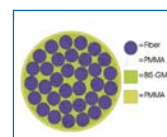

Everstick



7009005



7009007



7009008

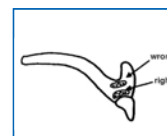

Reinforcement



4009566



4009566



4009566

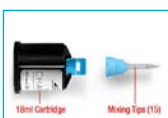

4009565



5851000



Perma Block



Implantlink



7008001

NUMBER	PRODUCT NAME	PRICE
<p>Chairside: pink dual-cure Bis-Acryl chairside attachment pickup material, odorless and tasteless. Working time 2 minutes and 15 seconds, curing time 7 minutes (self cure). 4mL syringe enables the pickup of about 30 attachments</p>		
4009566	CHAIRSIDE Pickup Material 4mL <i>Syringe and Plunger , 15 Mixing Tips, 15 Angled Tips</i>	79.50
4009565	CHAIRSIDE Pickup Material 18mL <ul style="list-style-type: none"> • Syringe and Plunger • 10 Mixing Tips • 10 Angled Tips <i>Low viscosity provides excellent control during chairside pickup. Ideal for picking up Temporary Cylinders in hybrid dentures!</i> <i>Optimal handling characteristics:</i> <ul style="list-style-type: none"> • Tissue-colored material bonds to itself. • Dual cure – self or light cure. • Will set in approximately 5 minutes. The working time is approximately 2 minutes and 15 seconds. • The material will self cure in approximately 7 minutes. Curing time can be shortened by light curing. <i>Learn more at preat.com</i>	229.00
4009549	Denture Removal Tool (10-Pack) Simple prostheses removal tool, ideal for overdentures	49.99
5851000	Perma Block Kit (4) 1.2mL syringes with 20 tips	50.00
0907500	Implantlink Temporary Cement	89.00
0907510	Implantlink Tips (25-Pack) <i>The first removable semi-permanent cement designed specifically for implant restorations.</i> <ul style="list-style-type: none"> * Dual cure for quick and easy application * Light cure allows for easy to remove excess cement to maintain periimplant health * Strong enough to provided stability, yet easy to remove without damage 	41.25
7008001	Wagner Impression Tray Mandibular	21.00
7008002	Wagner Impression Tray Maxillary <i>Create a custom tray quality impression in just one short appointment.</i> <i>The Wagner Tray is ready in just minutes. A Wagner Tray is customized chairside and in your patient's mouth, eliminating the need for a second appointment.</i>	21.00

Implant Buddy

SERVICE 99% OF IMPLANT CASES WITH ONE HANDY SET

#9000000

NEW

The Omega Torque Wrench



• Works hand in hand with the Implant Buddy

• High Precision Calibrated Torque

• Adjust from 10 to 70 Ncm!!

9000020

EASY STERILIZATION

EITHER THE INDIVIDUAL DRIVER(S) OR THE ENTIRE BUDDY!

TAPERED BITS

FOR A STRONGER CONNECTION

SHORT & LONG BITS

FOR EACH PROSTHETIC SCREW CONNECTION

SHORT & LONG DRIVER

SMART THUMB KNOB

GOES DIRECTLY INTO TORQUE DRIVER

COLOR CODED BITS

FOR EASY VISIBILITY

SMALL SIZE
PROVIDES MORE WORKING SPACE

MAGNETIC BASE

ALL COMPONENTS STAY IN PLACE AND ON THE SURGICAL TRAY

SERVICEABLE DESIGN

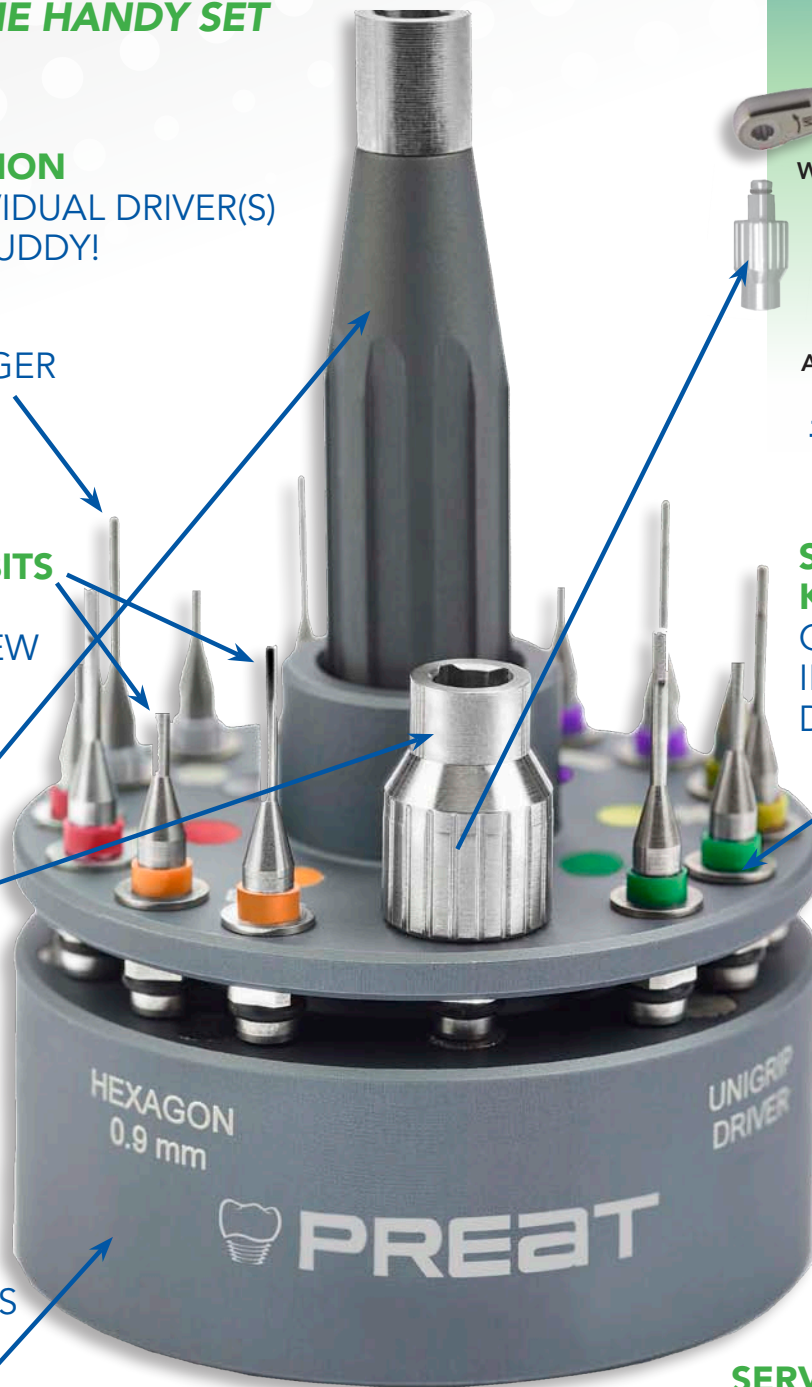

Prosthetic Connections Included:

Straight, SCS, UniGrip, Hex 1.3mm/.050 inch, Hex 1.2mm/.048 inch, Hex 0.9mm/.035 inch, and Square 1.3mm/.050 inch

PREAT.com

 **PREAT**

1-800-232-7732

REMOVABLE PROSTHETIC SPECIALTY



Perma Ret



0109000



Perma Ret

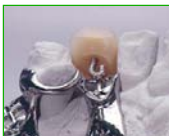

Perma Ret



6000005



Gingivamoll



Gingivamoll



Gingivamoll

NUMBER	PRODUCT NAME	PRICE
--------	--------------	-------

Perma Ret: a simple solution for Permanent Retention of acrylic and composite denture teeth in both full and partial dentures. Simply drill a small hole in the tooth with the provided twist drill. Cut a length of silver wire and insert in the wire holder. Thread the wire into the tooth. Bend the wire into desired position. Then process the denture base material.

0109000	Perma Ret Kit 3 twist drills, 1 wire holder, and 13 pieces of 80mm long threaded silver wire	172.00
0109002	Perma Ret Wire Refill 13 pieces of 80mm long threaded silver wire	140.00
0109002-6	Perma Ret Wire Refill (6-Pack)	720.00
0109004	Perma Ret Twist Drills (3)	28.00
0109006	Perma Ret Tool	34.00
6000005	Denture Stippling Mandrel <i>The 1/4 inch shaft will fit most standard chucks on a dental lathe. The user should place 4 of either a #2, #4, or #6 round straight handpiece or FG steel or carbide burs into the stippling mandrel and tighten securely with the Allen wrench that is included with the stippling mandrel. Best results are achieved using dull or used burs. *Burs are not included with the mandrel*</i>	45.00

Gingivamoll: a soft, flexible, silicone rubber removable gingival mask that esthetically replaces lost tissue and provides increased thermal comfort. This removable prosthesis is produced from surgical grade silicone rubber. The mask is very thin, fits comfortably, and is virtually undetectable in the mouth, blending with vital tissue.

0900001	Gingivamoll Starter Kit <i>Opaque material 4g, pink material 2.5g, stain 4g, light pink material 2.5g</i> <i>Stain liquid 5ml, red and blue dye, protective lacquer 5ml</i>	310.00
0906402	Gingivamoll Light Pink 5g	149.00
0906403	Gingivamoll Pink 5g	149.00
0906405	Gingivamoll Repair Material 15g	44.00

REMOVABLE PROSTHETIC SPECIALTY

NUMBER	PRODUCT NAME	PRICE
0906407	Gingivamoll Stain Liquid 15ml	24.00
0906411	Gingivamoll Protective Lacquer 15ml	46.00
0906412	Gingivamoll Opaque 10gram	380.00



0900001



0906402



0906403

Pro Blue: The finest single step polishing compound available. Water soluble for easy cleaning and a high shine on acrylic, composites, thermoplastics, and all alloys.

0601251	Pro Blue NTR Polishing Compound 150g	40.00
---------	--------------------------------------	-------

Unmounted Goat Hair Brush: soft goat hair Polishing Wheel with chamois insert. 51mm diameter. Excellent for final polishing of acrylics, composites, thermoplastics

0604066-3	Unmounted Goat Hair Brush (3-Pack)	39.00
0604066-12	Unmounted Goat Hair Brush (12-Pack)	138.00



0906411

Mounted Goad Hair Brush: 22mm diameter, 2.34mm length of shank. Excellent for final polishing of acrylics, composites, thermoplastics

0604068-6	Mounted Goat Hair Brush (6-Pack)	39.00
0604068-12	Mounted Goat Hair Brush (12-Pack)	72.00
0604068-36	Mounted Goat Hair Brush (36-Pack)	189.00
0604068-72	Mounted Goat Hair Brush (72-Pack)	378.00



0906412



0601251



0604066

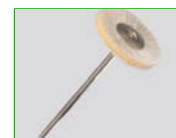

0604068

REMOVABLE PROSTHETIC SPECIALTY



Polishers



Polishers



06000F8



06000F9



0600F10



0600F11



0600F12



0600F13

NUMBER	PRODUCT NAME	PRICE
--------	--------------	-------

Silicone Cutter/Polishers: for final adjustment of acrylic denture base resins, eliminating mess and leaving a smooth surface. Use in either a handpiece or lathe at low to moderate speeds with light pressure to ensure efficient polishing of acrylic resin.

DESCIRPTION	ITEM NUMBER	6 - PACK	10 - PACK	25 - PACK	125 - PACK
F8 Silicone Cutters	06000F8	45.00	70.00	162.50	575.00
F9 Silicone Cutters	06000F9	45.00	70.00	162.50	575.00
F10 Silicone Cutters	06000F10	45.00	70.00	162.50	575.00
F11 Silicone Cutters	06000F11	45.00	70.00	162.50	575.00
F12 Silicone Cutters	06000F12	45.00	70.00	162.50	575.00
F13 Silicone Cutters	06000F13	45.00	70.00	162.50	575.00
F14 Silicone Cutters	06000F14	45.00	70.00	162.50	575.00
F15 Silicone Cutters	06000F15	45.00	70.00	162.50	575.00
F16 Silicone Cutters	06000F16	45.00	70.00	162.50	575.00

REMOVABLE PROSTHETIC SPECIALTY

NUMBER	PRODUCT NAME	PRICE
<p>Ceka Sol: Unique solder that contains its own flux and will solder any combination of precious, non-precious, chrome cobalt, or stainless steel alloys. Available in white or gold color.</p>		
3ZCS000	Ceka Sol	290.00
3ZCS200	Ceka Sol Gold	310.00
3ZCS210	Ceka Sol Light Gold	310.00
0604068-72	Ceka Sol White	310.00
3ZCS230	Ceka Sol Chrome	290.00
3ZCS310	Ceka Sol Titanium/Laser Strips (8-Pack)	310.00
3ZCS320	Ceka Sol Orax/Laser Strips (2-Pack)	85.00
3ZCS330	Ceka Sol Pallax/Laser Strips (2-Pack)	60.00



0600F14



0600F15



0600F16



Ceka Sol Solder

CEKA SOL							
	ORDER #	Composition in %	Melting Range	Color	Precious and Palladium-based alloys	Non-precious Alloys	Chrome-cobalt Alloys
CEKA SOL	CS00	Au-80 Cu-13 In-5 Zn-2	780° - 820° C	Yellow	X	X	
CEKA SOL W	CS22	Au-76.5 Cu-0.4 Zn-6.5 Ni-16.6	865° - 930° C	White	X	X	X
CEKA SOL L	CS21	Au-42 Ag-38.5 Zn-11 In-8.5	615° - 630° C	Light Yellow	X		X
CEKA SOL G	CS20	Au-68 Ag-13 Cu-13 Sn-2 Zn-5	755° - 820° C	Yellow	X		
CEKA SOL CR	CS23	Au-10 Ag-37 Pd-37 Cu-12 Zn-4	1000° - 1030° C	White			X



4008589



4008028



0101702



1776000



0101274



0101380



0101280

NUMBER	PRODUCT NAME	PRICE
4008589	Locator Bar Female (2) threaded 2mm	87.50
4008589-10	Locator Bar Female (10) threaded 2mm	415.00
4008028	Locator Bar Processing Package (2)	63.50
4008028-10	Locator Bar Processing Package (10)	284.00
0101702	Milled Hader Bar Attachment	30.00
1776000	Universal Plunger Loc Attachment	68.00
0101274	Universal Threaded Ball 2.2mm <i>Based on the universally accepted thread: M2 x .040 Our existing drill (4009102) and tap (4009104) may be used with the Universal Threaded Ball. Our existing drill (4009102) and tap (4009104) may be used with the Universal Threaded Ball</i>	40.00
0101380	Milled Bar Sagix Complete Attachment	72.00
0101280	Milled Bar Clix Complete Attachment	60.00
0101107	Dolder Bar Mini Gold Female 50mm*	225.00
0101111	Dolder Bar Mini Pallax Female 50mm	140.00
0101106	Dolder Bar Mini Pallax Female 50mm	310.00
0101109	Dolder Bar Standard Pallax Female 50mm	160.00
2R795TI	M2 Inverted Axial Acrylic	126.00
30895TI	M3 Invert Axial Acrylic TI	114.00

ALLOY CHART

Alloy Chart	
PALLAX	STAINLESS STEEL
White - Au 2 - Ag 37 - Pt 9.5 - Pd 37 - Cu 12.5 - Co 2 Melting range: 1055-1130 °C (1931-2066 °F)	White - Fe 66 - Cr 17 - Ni 11 - Mo 2 - other 4 - Do not heat!
IRAX - Precious	POLYPROPYLENE
White - Au 60 - Pt 24 - Pd 15 - Ir 1 Melting range: 1400-1460 °C (2552-2660 °F)	Hader Clips
NOPRAX - Non-precious	POLYACETAL
White - Au 2 - Ag 37 - Pt 9.5 - Pd 37 - Cu 12.5 - Co 2 Melting range: 1055-1130 °C (1931-2066 °F)	Clix, Sagix Females
ORAX	THERMOPLASTIC ELASTOMER
Yellow - Au 67 - Pt 8.6 - Ag 13.2 - Cu 11 - Zn 0.Y 2 Melting range: 910-995 °C (1670-1823°F) Heat treatment: 60 min at 400 °C (752 °F)	# 1201 B
PLATIRAX	TITANAX
White - Pt 85 - Ir 15 Melting range: 1790-1820 °C (3254-3308°F)	White - Ti 90 - Al 6 - V 4 - Do not heat!

SCREW IT IN, NOT UP!

45°

30°

20°

15°

10°

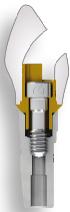

A FULL DIGITAL SYSTEM FOR ALL YOUR FULL ARCH RESTORATIONS:

Ti Base



Scanalog



Driver



ScAnalog
DYNAMIC ABUTMENT[®] SOLUTIONS

exocad

3shape

dental wings

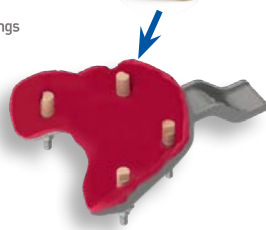

Digital Library

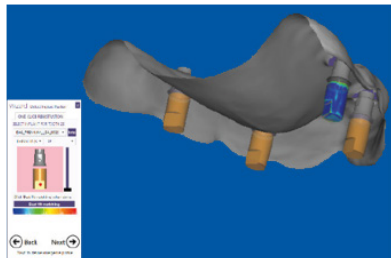
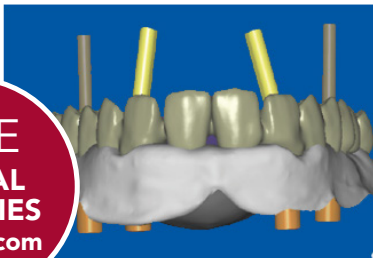

FREE DIGITAL LIBRARIES at Preat.com



FDA APPROVED

5 scan flags, 1 driver, 200+ platforms for Ti Bases

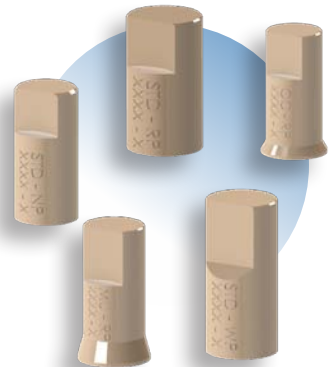

200+ PLATFORMS!

DYNAMIC ABUTMENT SOLUTION

NUMBER	PRODUCT NAME	PRICE
--------	--------------	-------

DRIVERS

800038	Dynamic Hexalobular 18mm Driver	80.00
800039	Dynamic Hexalobular 24mm Driver	80.00
800040	Dynamic Hexalobular 32mm Driver	80.00



8000039



8003765

SCAN BODY

8000197	Dynamic NP Compatible Scan Body For Titanium Base	51.00
8000198	Dynamic RP Compatible Scan Body For Titanium Base	51.00
8000196	Dynamic WP Compatible Scan Body For Titanium Base	51.00
8000199	Dynamic Straumann Tissue Level RN Scan Body For Titanium Base	51.00
8003765	Dynamic Nobel Multi-Unit Scan Body for Titanium Base	51.00



0906403



8004512

ZIMMER/TSV NP

8000112	Dynamic Zimmer TSV NP Engaging Tilite Abutment	118.00
8000113	Dynamic Zimmer TSV NP Engaging CrCo Abutment	118.00
8004512	Dynamic Zimmer TSV NP Non-Engaging CrCo Abutment	118.00
8004516	Dynamic Zimmer TSV NP Engaging Plastic UCLA	92.00
8000116	Dynamic Zimmer TSV NP Non-Engaging Plastic UCLA	92.00
8000154	Dynamic Zimmer TSV Screw M1.7 L7.1mm Torque 25Ncm	31.00
8004563	Dynamic Zimmer TSV NP Engaging Titanium Base	72.00
8000163	Dynamic Zimmer TSV NP Non-Engaging Titanium Base	72.00



8004516



8000154



8004563



8000163

ZIMMER/TSV RP

8000212	Dynamic Zimmer TSV RP Engaging Tilite Abutment	118.00
---------	--	--------

DYNAMIC ABUTMENT SOLUTION



8000363



8000411



8000412



8000416



8000417



8000454



8000463



8000464

NUMBER	PRODUCT NAME	PRICE
--------	--------------	-------

ZIMMER/TSV RP (cont'd)

8000113	Dynamic Zimmer TSV RP Engaging CrCo Abutment	118.00
8000216	Dynamic Zimmer TSV RP Non-Engaging Plastic Abutment	92.00
8004616	Dynamic Zimmer TSV RP Engaging Plastic UCLA	92.00
8004663	Dynamic Zimmer TSV RP Engaging Titanium Base	72.00
8000263	Dynamic Zimmer TSV RP Non-Engaging Titanium Base	72.00

ZIMMER/TSV WP

8000363	Dynamic Zimmer TSV WP Engaging Titanium Base	72.00
8000364	Dynamic Zimmer TSV WP Non-Engaging Titanium Base	72.00

NOBEL TRI-LOBE NP

8000411	Dynamic Nobel Tri-Lobe NP Engaging Plastic Abutment	92.00
8000412	Dynamic Nobel Tri-Lobe NP Engaging Tilite Abutment	92.00
8000416	Dynamic Nobel Tri-Lobe NP Non-Engaging Plastic Abutment	92.00
8000417	Dynamic Nobel Tri-Lobe NP Non-Engaging Tilite Abutment	92.00
8000454	Dynamic Nobel Tri-Lobe NP Screw M1.8 L7.5mm Torque 25Ncm	31.00
8000463	Dynamic Nobel Tri-Lobe NP Engaging Titanium Base	72.00
8000464	Dynamic Nobel Tri-Lobe NP Non-Engaging Titanium Base	72.00

NOBEL TRI-LOBE RP

8000511	Dynamic Nobel Tri-Lobe RP Engaging Plastic Abutment	92.00
8000512	Dynamic Nobel Tri-Lobe RP Engaging Tilite Abutment	118.00

DYNAMIC ABUTMENT SOLUTION

NUMBER	PRODUCT NAME	PRICE
8000513	Dynamic Nobel Tri-Lobe RP Engaging CrCo Abutment	118.00
8000554	Dynamic Nobel Tri-Lobe RP/WP Screw M2 L8.2mm Torque 25Ncm	31.00
8000516	Dynamic Nobel Tri-Lobe RP Non-Engaging Plastic Abutment	92.00
8000517	Dynamic Nobel Tri-Lobe RP Non-Engaging Tilite Abutment	118.00
8000563	Dynamic Nobel Tri-Lobe RP Engaging Titanium Base	72.00
8000564	Dynamic Nobel Tri-Lobe RP Non-Engaging Titanium Base	72.00

NOBEL TRI-LOBE WP

8000663	Dynamic Nobel Tri-Lobe WP Engaging Titanium Base	72.00
8000664	Dynamic Nobel Tri-Lobe WP Non-Engaging Titanium Base	72.00

NOBEL ACTIVE NP

8000811	Dynamic Nobel Active/Conical NP Engaging Plastic Abutment	92.00
8000812	Dynamic Nobel Active/Conical NP Engaging Tilite Abutment	118.00
8000813	Dynamic Nobel Active/Conical NP Engaging CrCo Abutment	118.00
8000814	Dynamic Nobel Active/Conical NP Non-Engaging CrCo Abutment	118.00
8000816	Dynamic Nobel Active/Conical NP Non-Engaging Plastic Abutment	92.00
8000817	Dynamic Nobel Active/Conical NP Non-Engaging Tilite Abutment	118.00
8000854	Dynamic Nobel Active/Conical NP Screw M1.6 L7.3mm Torque 20Ncm	31.00
8000863	Dynamic Nobel Active/Conical NP Engaging Titanium Base	72.00
8000864	Dynamic Nobel Active/Conical NP Non-Engaging Titanium Base	72.00



8000663



8000664



8000811



8000812



8000817



8000854



8000863



8000864

DYNAMIC ABUTMENT SOLUTION

110



8000911



8000912



8000913



8000916



8000917



8000954



8000963



8000964

NUMBER	PRODUCT NAME	PRICE
--------	--------------	-------

NOBEL ACTIVE RP

8000911	Dynamic Nobel Active/Conical RP Engaging Plastic Abutment	92.00
8000912	Dynamic Nobel Active/Conical RP Engaging Tilite Abutment	118.00
8000913	Dynamic Nobel Active/Conical RP Engaging CrCo Abutment	118.00
8000916	Dynamic Nobel Active/Conical RP Non-Engaging Plastic Abutment	92.00
8000917	Dynamic Nobel Active/Conical RP Non-Engaging Tilite Abutment	118.00
8000954	Dynamic Nobel Active/Conical RP/WP Screw M2 L7.5mm Torque 25Ncm	31.00
8000963	Dynamic Nobel Active/Conical RP Engaging Titanium Base	72.00
8000964	Dynamic Nobel Active/Conical RP Non-Engaging Titanium Base	72.00

NOBEL ACTIVE WP

8004963	Dynamic Active WP Engaging Titanium Base	72.00
8004964	Dynamic Active WP Non Engaging Titanium Base	72.00

BRANEMARK RP

8001011	Dynamic Branemark RP Non-Engaging Plastic Abutment	92.00
8001012	Dynamic Branemark RP Non-Engaging Tilite Abutment	118.00
8001013	Dynamic Branemark RP Engaging CrCo Abutment	118.00
8001016	Dynamic Branemark RP Engaging Plastic Abutment	92.00
8001017	Dynamic Branemark RP Engaging Tilite Abutment	118.00
8001053	Dynamic Branemark RP Screw M2 L6mm Torque 25Ncm	31.00
8001063	Dynamic Branemark RP Engaging Titanium Base	72.00
8001064	Dynamic Branemark RP Non-Engaging Titanium Base	72.00

DYNAMIC ABUTMENT SOLUTION

NUMBER	PRODUCT NAME	PRICE
STRAUMANN TL RN		
8001254	Dynamic Straumann Tissue Level RN Screw M2 L6.7 Mm Torque 25Ncm	31.00
8001263	Dynamic Straumann Tissue Level RN Engaging Titanium Base	72.00
8001264	Dynamic Straumann Tissue Level RN Non-Engaging Titanium Base	72.00



8001411



8001412

STRAUMANN BL RC

8001411	Dynamic Straumann Bone Level RC Engaging Plastic Abutment	92.00
8001412	Dynamic Straumann Bone Level RC Engaging Tilite Abutment	118.00
8001413	Dynamic Straumann Bone Level RC Non-Engaging CrCo	118.00
8001414	Dynamic Straumann Bone Level RC Engaging UCLA w/ CrCo	118.00
8001416	Dynamic Straumann Bone Level RC Non-Engaging Plastic Abutment	92.00
8001417	Dynamic Straumann Bone Level RC Non-Engaging Tilite Abutment	118.00
8001554	Dynamic Straumann Bone Level NC/RC Screw M1.6 L7.8 Mm Torque 20Ncm	31.00
8001463	Dynamic Straumann Bone Level RC Engaging Titanium Base	72.00
8001464	Dynamic Straumann Bone Level RC Non-Engaging Titanium Base	72.00



8001413



8001414



8001416



8001417

STRAUMANN BL NC

8001511	Dynamic Straumann Bone Level NC Engaging Plastic Abutment	92.00
8001512	Dynamic Straumann Bone Level NC Engaging Tilite Abutment	118.00
8001513	Dynamic Straumann Bone Level NC Engaging CrCo Abutment	118.00
8001514	Dynamic Straumann Bone Level NC Non-Engaging CrCo Abutment	118.00
8001516	Dynamic Straumann Bone Level NC Non-Engaging Plastic Abutment	92.00



8001554



8001463

DYNAMIC ABUTMENT SOLUTION



8001611



8001612



8001616



8001654



8001663



8001664



8001863



8001864

NUMBER	PRODUCT NAME	PRICE
--------	--------------	-------

STRAUMANN BL NC (cont'd)

8001517	Dynamic Straumann Bone Level NC Non-Engaging Tilite Abutment	118.00
8001563	Dynamic Straumann Bone Level NC Engaging Titanium Base	72.00
8001564	Dynamic Straumann Bone Level NC Non-Engaging Titanium Base	72.00

3i CERTAIN NP

8001611	Dynamic 3i Certain NP Engaging Plastic Abutment	92.00
8001612	Dynamic 3i Certain NP Engaging CrCo Abutment	118.00
8001616	Dynamic 3i Certain NP Non-Engaging Plastic UCLA	92.00
8001654	Dynamic 3i Certain NP/RP/5.0mm Screw M1.6 L8.4mm Torque 20Ncm	31.00
8001663	Dynamic 3i Certain NP Engaging Titanium Base	72.00
8001664	Dynamic 3i Certain NP Non-Engaging Titanium Base	72.00

3i CERTAIN RP

8001711	Dynamic 3i Certain RP Engaging Plastic Abutment	92.00
8001712	Dynamic 3i Certain RP Engaging CrCo Abutment	118.00
8001714	Dynamic 3i Certain RP Non-Engaging CrCo Abutment	118.00
8001716	Dynamic 3i Certain RP Non-Engaging Plastic Abutment	92.00
8001763	Dynamic 3i Certain RP Engaging Titanium Base	72.00
8001764	Dynamic 3i Certain RP Non-Engaging Titanium Base	72.00

3i CERTAIN 5.0

8001863	Dynamic 3i Certain 5.0 Engaging Titanium Base	72.00
8001864	Dynamic 3i Certain 5.0 Non Engaging Titanium Base	72.00

DYNAMIC ABUTMENT SOLUTION

NUMBER	PRODUCT NAME	PRICE
ASTRA 3.0		
8002054	Dynamic Astra 3.0 Screw M1.4 L7.0mm Torque 15Ncm	31.00
8002063	Dynamic Astra 3.0 Engaging Titanium Base	72.00
8002064	Dynamic Astra Aqua 3.0 Non-Engaging Titanium Base	72.00



8002054



8002111

ASTRA 3.5/4.0 (AQUA)

8002111	Dynamic Astra Aqua 3.5/4.0mm Engaging Plastic Abutment	92.00
8002112	Dynamic Astra Aqua 3.5/4.0mm Engaging CrCo Abutment	118.00
8002116	Dynamic Astra Aqua 3.5/4.0mm Non-Engaging Plastic Abutment	92.00
8002117	Dynamic Astra Aqua 3.5/4.0 Non-Engaging CrCo Dynamic Abutment	118.00
8002152	Dynamic Astra Aqua 3.5/4.0 Screw M1.6 L7.6mm Torque 20Ncm	31.00
8002163	Dynamic Astra Aqua 3.5/4.0 Engaging Titanium Base	72.00
8002164	Dynamic Astra Aqua 3.5/4.0 Non-Engaging Titanium Base	72.00



8002112



8002116



8002117

ASTRA 4.5/5.0 (LILAC)

8002254	Dynamic Astra Lilac 4.5/5.0 WP Screw M2 L9.0mm Torque 20Ncm	31.00
8002263	Dynamic Astra Lilac 4.5/5.0mm WP Engaging Titanium Base	72.00
8002264	Dynamic Astra Lilac 4.5/5.0mm WP Non-Engaging Titanium Base	72.00



8002152



8002163

3i OSSEOTITE NP

8002712	Dynamic 3i Osseotite NP Engaging Tilite Abutment	118.00
8002716	Dynamic 3i Osseotite NP Non-Engaging Plastic Abutment	92.00
8002717	Dynamic 3i Osseotite NP Non-Engaging Tilite Abutment	118.00



8002165

DYNAMIC ABUTMENT SOLUTION



8003363



8003364



8003463



8003464



8003716



8003717



8003754



8003764

NUMBER	PRODUCT NAME	PRICE
--------	--------------	-------

3i OSSEOTITE NP (cont'd)

8002754	Dynamic 3i Osseotite NP Screw M2 L 6.5mm Torque 25Ncm	31.00
8002763	Dynamic 3i Osseotite NP Engaging Titanium Base	72.00
8002764	Dynamic 3i Osseotite NP Non-Engaging Titanium Base	72.00

CAMLOG 3.8

8003354	Dynamic CAMLOG Screw-Line 3.8/4.3mm Screw M1.6 L 9.4mm Torque 20Ncm	31.00
8003363	Dynamic CAMLOG Screw-Line 3.8mm Engaging Titanium Base	72.00
8003364	Dynamic CAMLOG Screw-Line 3.8mm Non-Engaging Titanium Base	72.00

CAMLOG 4.3

8003463	Dynamic CAMLOG Screw-Line 4.3mm Engaging Titanium Base	72.00
8003464	Dynamic CAMLOG Screw-Line 4.3mm Non-Engaging Titanium Base	72.00

MULTI-UNIT

8003716	Dynamic Nobel Multi-Unit Non-Engaging Plastic Abutment	92.00
8003717	Dyanmic Nobel Multi-Unit Non-Engaging Tilite Abutment	118.00
8003754	Dynamic Nobel Multi Unit Screw M1.4 L4mm Torque 15Ncm	31.00
8003764	Dynamic Nobel Multi-Unit Non-Engaging Titanium Base	72.00

ASTRA EV 3.6

8003812	Dynamic Astra EV 3.6mm Engaging CrCo Abutment	118.00
8003816	Dynamic Astra EV 3.6mm Non-Engaging Plastic Abutment	92.00
8003854	Dynamic Astra EV 3.6 Screw M1.6 L 7.2mm Torque 20Ncm	31.00

DYNAMIC ABUTMENT SOLUTION

NUMBER	PRODUCT NAME	PRICE
ASTRA EV 3.6 (cont'd)		
8003863	Dynamic Astra EV 3.6mm Engaging Titanium Base	72.00
8003864	Dynamic Astra EV 3.6mm Non-Engaging Titanium Base	72.00



8003812



8003816

ASTRA EV 4.2

8003912	Dynamic Astra EV 4.2mm Engaging CrCo Abutment	118.00
8003916	Dynamic Astra EV 4.2mm Non-Engaging Plastic Abutment	92.00
8003954	Dynamic Astra EV 4.2mm Screw M1.8 L7.4mm Torque 25Ncm	31.00
8003963	Dynamic Astra EV 4.2mm Engaging Titanium Base	72.00
8003964	Dynamic Astra EV 4.2mm Non-Engaging Titanium Base	72.00



8003854



8003863

NEOSS

8004154	Dynamic Neoss Screw M,2 L 7,4mm 25n.Cm	31.00
8004163	Dynamic Neoss 4.1mm Engaging Titanium Base	72.00
8004164	Dynamic Neoss 4.1mm Non-Engaging Titanium Base	72.00



8003864



8004154

BRANEMARK NP

8002712	Dynamic Branemark NP Engaging Tilite Abutment	118.00
8004216	Dynamic Branemark NP Non-Engaging Plastic Abutment	92.00
8004217	Dynamic Branemark NP Non-Engaging Tilite Abutment	118.00
8004253	Dynamic Branemark NP Screw M1.6 L6mm Torque 20Ncm	31.00
8004263	Dynamic Branemark NP Engaging Titanium Base	72.00
8004264	Dynamic Branemark NP Non-Engaging Titanium Base	72.00



8004163



8004164

DYNAMIC ABUTMENT SOLUTION



8004354



8004363



8004364



8005111



8005113



8005114



8005116



8004454

NUMBER	PRODUCT NAME	PRICE
--------	--------------	-------

HIOSSSEN MINI

8005063	Dynamic Hiossen Mini NP Engaging Titanium Base	72.00
8005064	Dynamic Hiossen Mini NP Non-Engaging Titanium Base	72.00
8005055	Dynamic Hiossen NP Screw M1.6 L9.4mm Toque 20Ncm	31.00

HIOSSSEN STD/MEGAGEN ANYONE

8005111	Dynamic Hiossen HG Standard Engaging Plastic Abutment	92.00
8005113	Dynamic Hiossen HG Standard Engaging CrCo Abutment	118.00
8005114	Dynamic Hiossen HG Standard Non-Engaging CrCo Abutment	118.00
8005116	Dynamic Hiossen HG Standard Non-Engaging Plastic Abutment	92.00
8004354	Dynamic Megagen Anyone RP Screw	31.00
8004363	Dynamic Megagen Anyone RP Engaging Titanium Base	72.00
8004364	Dynamic Megagen Anyone RP Non-Engaging Titanium Base	72.00

MEGAGEN ANYRIDGE

8004412	Dynamic Megagen Anyridge Engaging CrCo Abutment	118.00
8004454	Dynamic Megagen Anyridge RP Titanium Screw M1.8 L7.5mm Torque 25Ncm	92.00
8004463	Dynamic Megagen Anyridge RP Engaging Titanium Base	72.00
8004464	Dynamic Megagen Anyridge RP Non-Engaging Titanium Base	72.00

DYNAMIC ABUTMENT SOLUTION

NUMBER	PRODUCT NAME	PRICE
--------	--------------	-------

BIOHORIZONS 3.0

8005254	Dynamic Biohorizons 3.0 Scew M1.7 L6.5mm Torque 25Ncm	31.00
8005263	Dynamic Biohorizons 3.0 Engaging Titanium Base w/screw	72.00
8005264	Dynamic Biohorizons 3.0 Non-Engaging TI Base w/screw	72.00



8005063



8005064

KEYSTONE PRIMA CONNEX 3.5

8005754	Dynamic Prima 3.5/4.1/5.0 Screw M1.8 L6.5mm Torque 25Ncm	31.00
8005763	Dynamic Prima 3.5mm Engaging Titanium Base w/screw	72.00
8005764	Dynamic Prima 3.5mm Non-Engaging Titanium Base	72.00



8005055



8005254

KEYSTONE PRIMA CONNEX 4.1

8005863	Dynamic Prima 4.1mm Engaging Titanium Base w/screw	72.00
8005864	Dynamic Prima 4.1mm Non-Engaging Titanium Base w/screw	72.00



8005263

KEYSTONE PRIMA CONNEX 5.0

8005963	Dynamic Prima 5.0mm Engaging Titanium Base w/screw	72.00
8005964	Dynamic Prima 5.0mm Non-Engaging Titanium Base w/screw	72.00



8005264



8005963



8005964

DYNAMIC ABUTMENT SOLUTIONS WORKFLOW

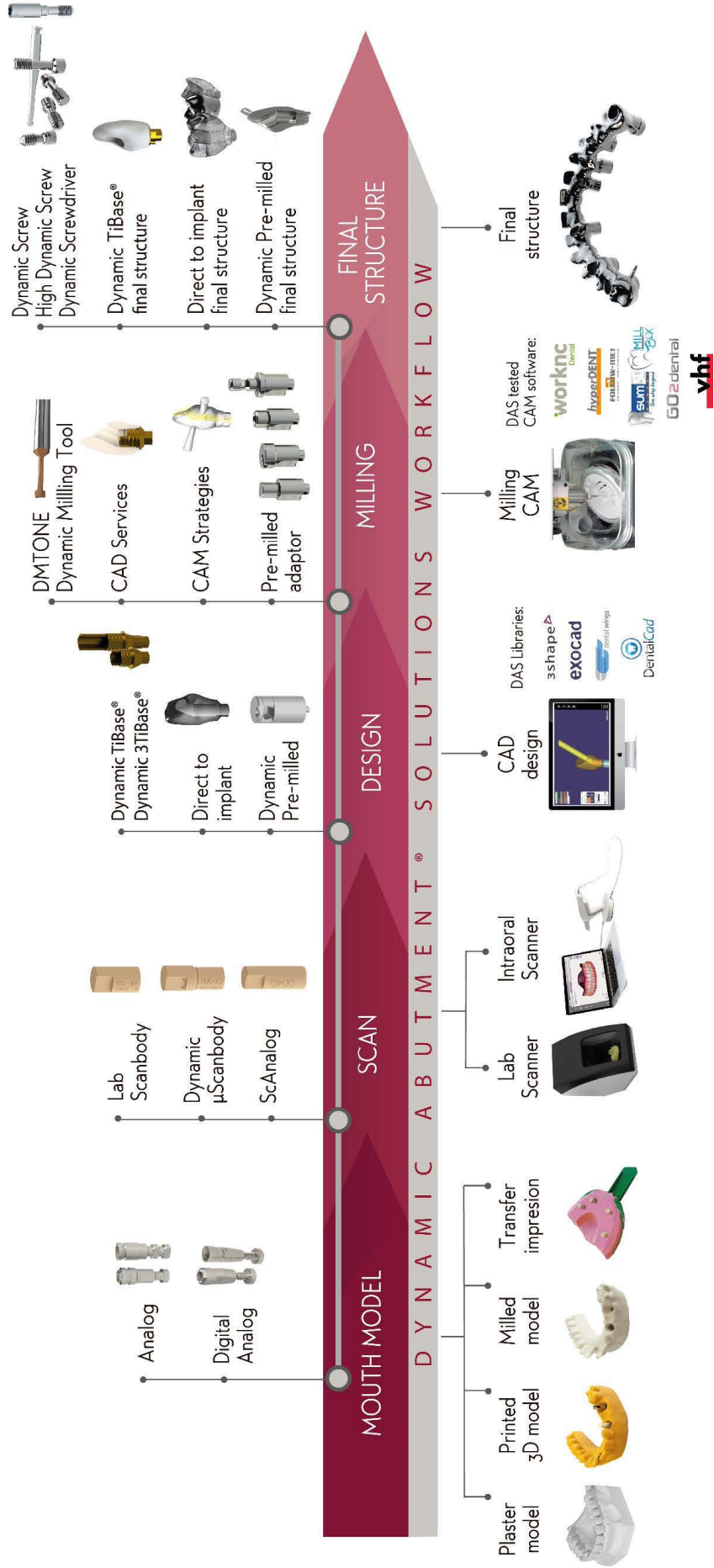

MULTI-UNIT COMPONENTS

NUMBER	PRODUCT NAME	PRICE
<p>PREAT Multi-Unit Components are compatible with the following Multi-Unit abutments: 3i Low Profile, Biohorizons Multi-Unit, Keystone Multi-Unit (new version), Blue Sky Bio Multi-Unit, Glidewell Inclusive/Hahn, Ace, Straumann SRA (4.6mm Only), Hiossen Multi-Unit, and Nobel Biocare</p>		
4008909-2	LOCATOR for Multi-Unit Abutment TI (2-Pack)	260.00
9003700	Multi-Unit Analog	16.00
9003700-10	Multi-Unit Analog (10-Pack)	140.00
9003701	Multi-Unit Open Tray Impression Coping	28.00
8003702	Multi-Unit Closed Tray Impression Coping	28.00
9003730	Multi-Unit Non-Engaging Verification Cylinder	38.00
9003730-10	Multi-Unit Non-Engaging Verification Cylinder	340.00
8003750	Multi-Unit Titanium Screw (Unigrip)	16.00
8003750-10	Multi-Unit Titanium Screw (Unigrip) (10-Pack)	130.00
9003751	Multi-Unit Titanium Screw (.050 Hex)	16.00
9003751-10	Multi-Unit Titanium Screw (.050 Hex) (10-Pack)	130.00
8003754	Multi-Unit Dynamic Titanium Screw	30.00
9003753	Multi-Unit Guide Pin 20mm	16.00
8003740	Multi-Unit Abutment Blue Light Scan Body	25.00
8003760	Multi-Unit Non-Engaging Titanium Base	50.00
8003764	Multi-Unit Non-Engaging Dynamic Titanium Base	72.00
8003705	Multi-Unit Driver	40.00
8003720	Multi-Unit Gold/Plastic Coping	115.00
8003725	Multi-Unit Gold Bar Coping	115.00



4008909



9003700



8003701



9003730



8003750

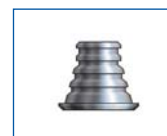

8003751



8003764



8003720

NUMBER	PRODUCT NAME	PRICE
8003710	Multi-Unit Abutment Plastic Coping	48.00
9003704	Bidra Conversion Smart Polishing Cap (Long)	30.00
9003704-4	Bidra Conversion Smart Polishing Cap (Long) (4-Pack)	100.00
9003705	Bidra Conversion Smart Polishing Cap (Short)	30.00
9003705-4	Bidra Conversion Smart Polishing Cap (Short) (4-Pack)	100.00

THE BIDRA CONVERSION SMART POLISHING CAP

With an extended metal rim, the Bidra Conversion Smart Polishing Cap fully protects both the inside and outside of the metal coping, preventing damage to the coping when setting the acrylic, and while trimming, polishing and finishing the prosthesis.

External rough areas attract bacteria and may lead to soft tissue inflammation and bone loss around the implants. Existing polishing caps only protect the inside of the coping, not the outside.

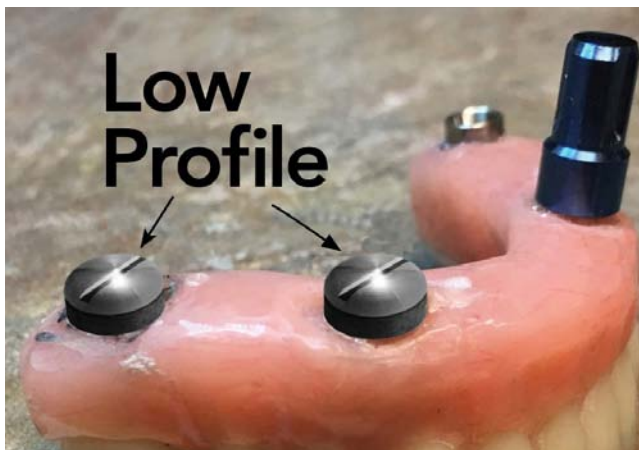

PROTECT YOUR NEXT FULL ARCH IMPLANT CONVERSION.



Images courtesy of:

Dr. Avinash S. Bidra, BDS, MS, FACP
Dr. E. Armand Bedrossian, DDS, MSD

NUMBER	PRODUCT NAME	PRICE
--------	--------------	-------

Certain 3.4mm NP Internal Connection

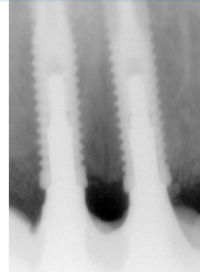
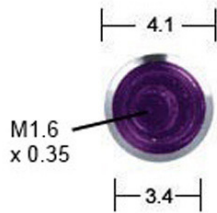

9001600

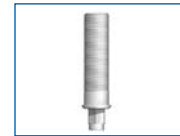

8001610



8001615



8001650



8001651



9001630



9001635v



8001661

9001600	3i Certain 3.4mm Analog	15.00
9001600-10	3i Certain 3.4mm Analog (10-Pack)	130.00
9001600-25	3i Certain 3.4mm Analog (25-Pack)	300.00
8001610	3i Certain 3.4mm Engaging Plastic UCLA	42.00
8001610-10	3i Certain 3.4mm Engaging Plastic UCLA (10-Pack)	350.00
8001615	3i Certain 3.4mm Non-Engaging Plastic UCLA	42.00
8001615-10	3i Certain 3.4mm Non-Engaging Plastic UCLA (10-Pack)	350.00
9001650	3i Certain 3.4mm/4.1mm/5mm/6mm Titanium Screw	15.00
9001650-10	3i Certain 3.4mm/4.1mm/5mm/6mm Titanium Screw (10-Pack)	130.00
9001651	3i Certain 3.4mm/4.1mm/5mm/6mm Guide Pin 20mm	15.00
9001630	3i Certain 3.4mm Engaging Verification Cylinder	42.00
9001630-10	3i Certain 3.4mm Engaging Verification Cylinder (10-Pack)	350.00
9001635	3i Certain 3.4mm Non-Engaging Verification Cylinder	42.00
9001635-10	3i Certain 3.4mm Non-Engaging Verification Cylinder (10-Pack)	350.00
8001661	3i Certain 3.4mm x 4.5mm Engaging Titanium Base	50.00



8001662



8001670



8001640



8001671



8001676



8001680



8001676



1601604C

NUMBER	PRODUCT NAME	PRICE
8001662	3i Certain 3.4mm x 6mm Engaging Titanium Base	50.00
8001659	3i Certain 3.4mm x 4.5mm Non-Engaging Titanium Base	50.00
8001640	3i Certain 3.4mm Blue Light Scan Body	25.00
8001670	3i Certain 3.4mm Esthetic Abutment 15° Angle, Anterior	105.00
8001671	3i Certain 3.4mm Esthetic Abutment Straight, Anterior	105.00
8001675	3i Certain 3.4mm Straight Multi-Unit Abutment x 1mm	125.00
8001676	3i Certain 3.4mm Straight Multi-Unit Abutment x 2mm	125.00
8001677	3i Certain 3.4mm Straight Multi-Unit Abutment x 3mm	125.00
8001680	3i Certain 3.4mm 17° Multi-Unit Abutment x 2mm	125.00
8001681	3i Certain 3.4mm 17° Multi-Unit Abutment x 3mm	125.00
8001789	3i Certain 3.4/4.1/5.0/6.0mm Multi-Unit Titanium Screw	16.00
8001659	3i Certain 3.4mm Non-Engaging Titanium Base	50.00
1601602C	Clix Complete Ball Abutment for 3i Certain 3.4mm x 2mm	95.00
1601604C	Clix Complete Ball Abutment for 3i Certain 3.4mm x 4mm	95.00



8001789



1601604C

NUMBER	PRODUCT NAME	PRICE
--------	--------------	-------

Certain 4.1mm RP Internal Connection



9001700	3i Certain 4.1mm Analog	15.00
9001700-10	3i Certain 4.1mm Analog (10-Pack)	130.00
9001700-25	3i Certain 4.1mm Analog (25-Pack)	300.00
8001710	3i Certain 4.1mm Engaging Plastic UCLA	42.00
8001710-10	3i Certain 4.1mm Engaging Plastic UCLA (10-Pack)	350.00
8001715	3i Certain 4.1mm Non-Engaging Plastic UCLA	42.00
8001715-10	3i Certain 4.1mm Non-Engaging Plastic UCLA (10-Pack)	350.00
9001650	3i Certain 3.4mm/4.1mm/5mm/6mm Titanium Screw	15.00
9001650-10	3i Certain 3.4mm/4.1mm/5mm/6mm Titanium Screw (10-Pack)	130.00
9001651	3i Certain 3.4mm/4.1mm/5mm/6mm Guide Pin 20mm	15.00
9001730	3i Certain 4.1mm Engaging Verification Cylinder	42.00
9001730-10	3i Certain 4.1mm Engaging Verification Cylinder (10-Pack)	350.00
9001735	3i Certain 4.1mm Non-Engaging Verification Cylinder	42.00
9001735-10	3i Certain 4.1mm Non-Engaging Verification Cylinder (10-Pack)	350.00
8001761	3i Certain 4.1mm x 4.5mm Engaging Titanium Base	50.00



9001700



8001710



8001715



9001650



9001651



9001730



9001735



8001761



8001762



8001740



8001770



8001771



8001772



8001776



8001771



1601702C



1601702C



1601702C

NUMBER	PRODUCT NAME	PRICE
8001762	3i Certain 4.1mm x 6mm Engaging Titanium Base	50.00
8001759	3i Certain 4.1mm x 4.5mm Non-Engaging Titanium Base	50.00
8001740	3i Certain 4.1mm Blue Light Scan Body	25.00
8001770	3i Certain 4.1mm Esthetic Abutment 15° Angle, Anterior	105.00
8001771	3i Certain 4.1mm Esthetic Abutment Straight, Anterior	105.00
8001772	3i Certain 4.1mm Esthetic Abutment 15° Angle, Posterior	105.00
8001773	3i Certain 4.1mm Esthetic Abutment Straight, Posterior	105.00
8001775	3i Certain 4.1mm Straight Multi-Unit Abutment x 1mm	125.00
8001776	3i Certain 4.1mm Straight Multi-Unit Abutment x 2mm	125.00
8001777	3i Certain 4.1mm Straight Multi-Unit Abutment x 3mm	125.00
8001779	3i Certain 4.1mm Straight Multi-Unit Abutment x 5mm	125.00
8001780	3i Certain 4.1mm 17° Multi-Unit Abutment x 2mm	125.00
8001781	3i Certain 4.1mm 17° Multi-Unit Abutment x 3mm	125.00
8001786	3i Certain 4.1mm 30° Multi-Unit Abutment x 4mm	125.00
8001787	3i Certain 4.1mm 30° Multi-Unit Abutment x 5mm	125.00
8001789	3i Certain 3.4/4.1/5.0/6.0mm Multi-Unit Titanium Screw	16.00
1601702C	Clix Complete Ball Abutment for 3i Certain 4.1mm x 2mm	95.00
1601704C	Clix Complete Ball Abutment for 3i Certain 4.1mm x 4mm	95.00

NUMBER	PRODUCT NAME	PRICE
--------	--------------	-------

Certain 5.0mm WP Internal Connection

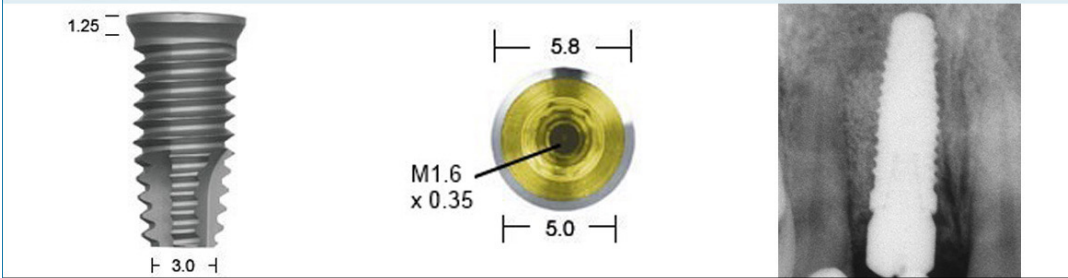

9001800	3i Certain 5.0mm Analog	15.00
9001800-10	3i Certain 5.0mm Analog (10-Pack)	130.00
9001800-25	3i Certain 5.0mm Analog (25-Pack)	300.00
8001810	3i Certain 5.0mm Engaging Plastic UCLA	42.00
8001810-10	3i Certain 5.0mm Engaging Plastic UCLA (10-Pack)	350.00
8001815	3i Certain 5.0mm Non-Engaging Plastic UCLA	42.00
8001815-10	3i Certain 5.0mm Non-Engaging Plastic UCLA (10-Pack)	350.00
9001650	3i Certain 3.4mm/4.1mm/5mm/6mm Titanium Screw	15.00
9001650-10	3i Certain 3.4mm/4.1mm/5mm/6mm Titanium Screw (10-Pack)	130.00
9001651	3i Certain 5.0mm Guide Pin 20mm	15.00
9001830	3i Certain 5.0mm Engaging Verification Cylinder	42.00
9001830-10	3i Certain 5.0mm Engaging Verification Cylinder (10-Pack)	350.00
9001865	3i Certain 5.0mm Non-Engaging Verification Cylinder	42.00
9001865-10	3i Certain 5.0mm Non-Engaging Verification Cylinder (10-Pack)	350.00
8001859	3i Certain 5.0mm Non-Engaging Titanium Base	50.00



9001800

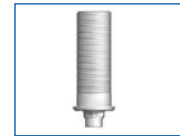

8001810



8001815



9001650



9001651



9001830



9001865



8001859



8001840



8001870



8001871



8001873



8001875



8001880



8001789



8001900

NUMBER	PRODUCT NAME	PRICE
8001861	3i Certain 5.0mm x 4.5mm Engaging Titanium Base	50.00
8001862	3i Certain 5.0mm x 6mm Engaging Titanium Base	50.00
8001840	3i Certain 5.0mm Blue Light Scan Body	25.00
8001870	3i Certain 5.0mm Esthetic Abutment 15° Angle, Anterior	105.00
8001871	3i Certain 5.0mm Esthetic Abutment Straight, Anterior	105.00
8001872	3i Certain 5.0mm Esthetic Abutment 15° Angle, Posterior	105.00
8001873	3i Certain 5.0mm Esthetic Abutment Straight, Posterior	105.00
8001875	3i Certain 5.0mm Straight Multi-Unit Abutment x 1mm	125.00
8001876	3i Certain 5.0mm Straight Multi-Unit Abutment x 2mm	125.00
8001877	3i Certain 5.0mm Straight Multi-Unit Abutment x 3mm	125.00
8001880	3i Certain 5.0mm 17° Multi-Unit Abutment x 2mm	125.00
8001881	3i Certain 5.0mm 17° Multi-Unit Abutment x 3mm	125.00
8001789	3i Certain 3.4/4.1/5.0/6.0mm Multi-Unit Titanium Screw	16.00



8001880



8001789



8001900

Certain 6.0mm WP Internal Connection		
8001900	3i Certain 6.0mm Analog	15.00
8001900-10	3i Certain 6.0mm Analog (10-Pack)	130.00

NUMBER	PRODUCT NAME	PRICE
8001900-25	3i Certain 6.0mm Analog (25-Pack)	300.00
8001910	3i Certain 6.0mm Engaging Plastic UCLA	42.00
8001910-10	3i Certain 6.0mm Engaging Plastic UCLA (10-Pack)	350.00
8001915	3i Certain 6.0mm Non-Engaging Plastic UCLA	42.00
8001915-10	3i Certain 6.0mm Non-Engaging Plastic UCLA (10-Pack)	350.00
9001650	3i Certain 3.4mm/4.1mm/5mm/6mm Titanium Screw	15.00
9001650-10	3i Certain 3.4mm/4.1mm/5mm/6mm Titanium Screw (10-Pack)	130.00
8001930	3i Certain 6.0mm Engaging Verification Cylinder	42.00
8001930-10	3i Certain 6.0mm Engaging Verification Cylinder (10-Pack)	350.00
8001935	3i Certain 6.0mm Non-Engaging Verification Cylinder	42.00
8001935-10	3i Certain 6.0mm Non-Engaging Verification Cylinder (10-Pack)	350.00
8001961	3i Certain 6.0mm x 4.5mm Engaging Titanium Base	50.00
8001962	3i Certain 6.0mm x 6mm Engaging Titanium Base	50.00
8001959	3i Certain 6.0mm x 4.5mm Non-Engaging Titanium Base	50.00
8001940	3i Certain 6.0mm Blue Light Scan Body	25.00
8001973	3i Certain 6.0mm Esthetic Abutment Straight, Posterior	105.00



8001910



8001915



9001650



8001930



8001935



8001962



8001940



8001973

NUMBER	PRODUCT NAME	PRICE
--------	--------------	-------

3.25mm & 3.3mm MicroMiniplant

3.75/4.0mm External Hex (Branemark compatible)

Please see page 159 for Branemark RP Compatible

3i External Hex Wide Platform (5.0)

Ace Surgical Implant Systems

ACE Infinity Internal 3.7/4.1 (3.5mmD)	Please see Zimmer TSV 3.5mm
ACE Infinity Internal 4.7/5.1 (4.5mmD)	Please see Zimmer TSV 4.5mm
ACE Infinity TRI-CAM 3.5mm	Please see Nobel Tri-Lobe NP
ACE Infinity TRI-CAM 4.3mm	Please see Nobel Tri-Lobe RP
ACE Infinity TRI-CAM 5.0mm	Please see Nobel Tri-Lobe WP
ACE Infinity X-hex 3.7/4.0	Please see Nobel Branemark RP
ACE Infinity X-hex 4.75	Please see Nobel Branemark WP
ACE Octagon Bone Level 3.3mm	Please see Nobel Tri-Active/Conical NP
ACE Octagon Bone Level 4.1mm	Please see Nobel Tri-Active/Conical RP

NUMBER	PRODUCT NAME	PRICE
Ankylos CX (indexed) Implant 3.5mm / 4.5mm / 5.5mm		

Ankylos C (non-indexed) Implant 3.5mm / 4.5mm / 5.5mm		

8004800	Ankylos C/X 3.5mm Analog	15.00
8004800-10	Ankylos C/X 3.5mm Analog (10-Pack)	130.00
8004800-25	Ankylos C/X 3.5mm Analog (25-Pack)	300.00
8004805	Ankylos C/X 4.5mm Analog	15.00
8004805-10	Ankylos C/X 4.5mm Analog (10-Pack)	130.00
8004805-25	Ankylos C/X 4.5mm Analog (25-Pack)	300.00
8004806	Ankylos C/X 5.5mm Analog	15.00
8004806-10	Ankylos C/X 5.5mm Analog (10-Pack)	130.00
8004806-25	Ankylos C/X 5.5mm Analog (25-Pack)	300.00
8004850	Ankylos C/X Titanium Screw	15.00
8004851	Ankylos C/X Guide Pin	15.00



Implants
ANKYLOS



8004840



8004857



8004861



8004870



8004871



8004872



8004875



8004878

NUMBER	PRODUCT NAME	PRICE
8004840	Ankylos C/X Blue Light Scan Body	25.00
8004857	Ankylos C/ 3.5mm x 4.5mm Non-Engaging Titanium Base	50.00
8004858	Ankylos C/ 4.5mm x 4.5mm Non-Engaging Titanium Base	50.00
8004859	Ankylos C/ 5.5mm x 4.5mm Non-Engaging Titanium Base	50.00
8004861	Ankylos /X 3.5mm X 4.5mm Titanium Base	50.00
8004863	Ankylos /X 3.5mm X 6mm Titanium Base	50.00
8004815	Ankylos C/ Non-Engaging Plastic UCLA	42.00
8004830	Ankylos /X Engaging Verification Cylinder	42.00
8004835	Ankylos C/ Non- Engaging Verification Cylinder	42.00
8004870	Ankylos /X Esthetic Abutment 15° Angle, Anterior	105.00
8004871	Ankylos /X Esthetic Abutment Straight, Anterior	105.00
8004872	Ankylos /X Esthetic Abutment 15° Angle, Posterior	105.00
8004873	Ankylos /X Esthetic Abutment Straight, Posterior	105.00
8004875	Ankylos /X Straight Multi-Unit Abutment x 1.5mm	125.00
8004876	Ankylos /X Straight Multi-Unit Abutment x 2.5mm	125.00
8004877	Ankylos /X Straight Multi-Unit Abutment x 3.5mm	125.00
8004878	Ankylos /X Straight Multi-Unit Abutment x 4.5mm	125.00

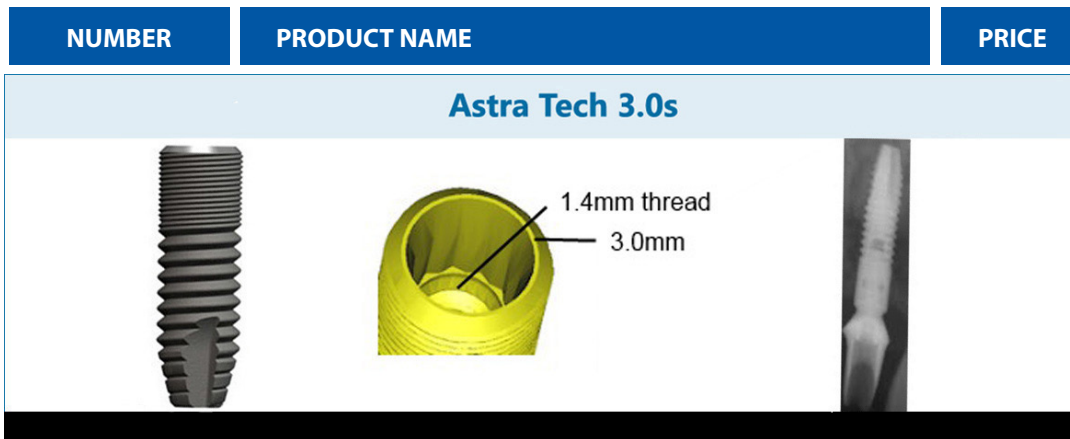

9002000	Astra 3.0mm Analog	15.00
9002000-10	Astra 3.0mm Analog (10-Pack)	130.00
9002000-25	Astra 3.0mm Analog (25-Pack)	300.00
8002010	Astra 3.0mm Engaging Plastic UCLA	42.00
8002010-10	Astra 3.0mm Engaging Plastic UCLA (10-Pack)	350.00
8002015	Astra 3.0mm Non-Engaging Plastic UCLA	42.00
8002015-10	Astra 3.0mm Non-Engaging Plastic UCLA (10-Pack)	350.00
8002030	Astra 3.0mm Engaging Verification Cylinder	42.00
8002030-10	Astra 3.0mm Engaging Verification Cylinder (10-Pack)	350.00
8002050	Astra 3.0mm Titanium Screw	15.00
8002050-10	Astra 3.0mm Titanium Screw (10-Pack)	130.00
8002051	Astra 3.0mm Guide Pin 20mm	15.00
8002061	Astra 3.0mm x 4.5mm Engaging Titanium Base	50.00
8002062	Astra 3.0mm x 6mm Engaging Titanium Base	50.00
8002040	Astra 3.0mm Blue Light Scan Body	25.00



9002000



8002010



8002015



8002030



8002050



8002051



8002062



8002040

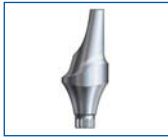

8002070



8002071



9002100



8002110



8002115



8002130



8002135



8002150

NUMBER	PRODUCT NAME	PRICE
8002070	Astra 3.0mm Esthetic Abutment 15° Angle, Anterior	105.00
8002071	Astra 3.0mm Esthetic Abutment Straight, Anterior	105.00

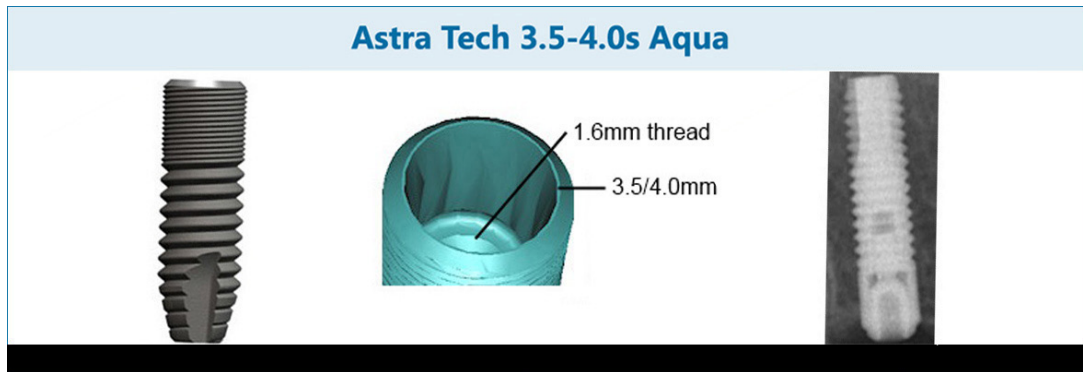

9002100	Astra Aqua 3.5/4.0mm Analog	15.00
9002100-10	Astra Aqua 3.5/4.0mm Analog (10-Pack)	130.00
9002100-25	Astra Aqua 3.5/4.0mm Analog (25-Pack)	300.00
8002110	Astra Aqua 3.5/4.0mm Engaging Plastic UCLA	42.00
8002110-10	Astra Aqua 3.5/4.0mm Engaging Plastic UCLA (10-Pack)	350.00
8002115	Astra Aqua 3.5/4.0mm Non-Engaging Plastic UCLA	42.00
8002115-10	Astra Aqua 3.5/4.0mm Non-Engaging Plastic UCLA (10-Pack)	350.00
8002130	Astra Aqua 3.5/4.0mm Engaging Verification Cylinder	42.00
8002130-10	Astra Aqua 3.5/4.0mm Engaging Verification Cylinder (10-Pack)	350.00
8002135	Astra Aqua 3.5/4.0mm Non-Engaging Verification Cylinder	42.00
8002135-10	Astra Aqua 3.5/4.0mm Non-Engaging Verification Cylinder (10-Pack)	350.00
8002150	Astra Aqua 3.5/4.0mm Titanium Screw	15.00
8002150-10	Astra Aqua 3.5/4.0mm Titanium Screw (10-Pack)	130.00

NUMBER	PRODUCT NAME	PRICE
8002151	Astra Aqua 3.5/4.0mm Guide Pin 20mm	15.00
8002161	Astra Aqua 3.5/4.0mm x 4.5mm Engaging Titanium Base	50.00
8002162	Astra Aqua 3.5/4.0mm x 6mm Engaging Titanium Base	50.00
8002159	Astra Aqua 3.5/4.0mm x 4.5mm Non-Engaging Titanium Base	50.00
8002140	Astra Aqua 3.5/4.0mm Blue Light Scan Body	25.00
8002170	Astra Aqua 3.5/4.0mm Esthetic Abutment 15° Angle, Anterior	105.00
8002171	Astra Aqua 3.5/4.0mm Esthetic Abutment Straight, Anterior	105.00
8002172	Astra Aqua 3.5/4.0mm Esthetic Abutment 15° Angle, Posterior	105.00
8002173	Astra Aqua 3.5/4.0mm Esthetic Abutment Straight, Posterior	105.00
8002175	Astra Aqua 3.5/4.0mm Straight Multi-Unit Abutment x 1.5mm	125.00
8002176	Astra Aqua 3.5/4.0mm Straight Multi-Unit Abutment x 2.5mm	125.00
8002177	Astra Aqua 3.5/4.0mm Straight Multi-Unit Abutment x 3.5mm	125.00
8002180	Astra Aqua 3.5/4.0mm 17° Multi-Unit Abutment x 2.5mm	125.00
8002181	Astra Aqua 3.5/4.0mm 17° Multi-Unit Abutment x 3.5mm	125.00
8002185	Astra Aqua 3.5/4.0mm 30° Multi-Unit Abutment x 3.5mm	125.00
8002186	Astra Aqua 3.5/4.0mm 30° Multi-Unit Abutment x 4.5mm	125.00
8002189	Astra Aqua 3.5/4.0 Multi-Unit Titanium Screw	16.00
1602102C	Clix Complete Ball Abutment Astra Aqua 3.5/4.0mm x 2mm	95.00
1602104C	Clix Complete Ball Abutment Astra Aqua 3.5/4.0mm x 4mm	95.00



8002161



8002140



8002170



8002171



8002175



8002181



8002186



8002189



9002200



8002210



8002215



8002230



8002235



8002250



8002251



8002261

NUMBER	PRODUCT NAME	PRICE
--------	--------------	-------



NUMBER	PRODUCT NAME	PRICE
9002200	Astra Lilac 4.5/5.0mm Analog	15.00
9002200-10	Astra Lilac 4.5/5.0mm Analog (10-Pack)	130.00
9002200-25	Astra Lilac 4.5/5.0mm Analog (25-Pack)	300.00
8002210	Astra Lilac 4.5/5.0mm Engaging Plastic UCLA	42.00
8002210-10	Astra Lilac 4.5/5.0mm Engaging Plastic UCLA (10-Pack)	350.00
8002215	Astra Lilac 4.5/5.0mm Non-Engaging Plastic UCLA	42.00
8002215-10	Astra Lilac 4.5/5.0mm Non-Engaging Plastic UCLA (10-Pack)	350.00
8002230	Astra Lilac 4.5/5.0mm Engaging Verification Cylinder	42.00
8002230-10	Astra Lilac 4.5/5.0mm Engaging Verification Cylinder (10-Pack)	350.00
8002235	Astra Lilac 4.5/5.0mm Non-Engaging Verification Cylinder	42.00
8002235-10	Astra Lilac 4.5/5.0mm Non-Engaging Verification Cylinder (10-Pack)	350.00
8002250	Astra Lilac 4.5/5.0mm Titanium Screw	15.00
8002250-10	Astra Lilac 4.5/5.0mm Titanium Screw (10-Pack)	130.00
8002251	Astra Lilac 4.5/5.0mm Guide Pin 20mm	15.00
8002261	Astra Lilac 4.5/5.0mm x 4.5mm Engaging Titanium Base	50.00

NUMBER	PRODUCT NAME	PRICE
8002262	Astra Lilac 4.5/5.0mm x 6mm Engaging Titanium Base	50.00
8002259	Astra Lilac 4.5/5.0mm x 4.5mm Non-Engaging Titanium Base	50.00
8002240	Astra Lilac 4.5/5.0mm Blue Light Scan Body	25.00
8002270	Astra Lilac 4.5/5.0mm Esthetic Abutment 15° Angle, Anterior	105.00
8002271	Astra Lilac 4.5/5.0mm Esthetic Abutment Straight, Anterior	105.00
8002272	Astra Lilac 4.5/5.0mm Esthetic Abutment 15° Angle, Posterior	105.00
8002273	Astra Lilac 4.5/5.0mm Esthetic Abutment Straight, Posterior	105.00
8002275	Astra Lilac 4.5/5.0mm Straight Multi-Unit Abutment x 1.5mm	125.00
8002276	Astra Lilac 4.5/5.0mm Straight Multi-Unit Abutment x 2.5mm	125.00
8002277	Astra Lilac 4.5/5.0mm Straight Multi-Unit Abutment x 3.5mm	125.00
8002278	Astra Lilac 4.5/5.0mm Straight Multi-Unit Abutment x 4.5mm	125.00
8002280	Astra Lilac 4.5/5.0mm 17° Multi-Unit Abutment x 2.5mm	125.00
8002281	Astra Lilac 4.5/5.0mm 17° Multi-Unit Abutment x 3.5mm	125.00
8002285	Astra Lilac 4.5/5.0mm 30° Multi-Unit Abutment x 3.5mm	125.00
8002286	Astra Lilac 4.5/5.0mm 30° Multi-Unit Abutment x 4.5mm	125.00
8002289	Astra Lilac 4.5/5.0mm Multi-Unit Titanium Screw	16.00
1602202C	Clix Complete Ball Abutment Astra Lilac 4.5/5.0mm x 2mm	95.00
1602204C	Clix Complete Ball Abutment Astra Lilac 4.5/5.0mm x 4mm	95.00



8002259



8002240



8002270



8002271



8002272



8002273



8002275



8002276



8002277

8002278

8002280

8002281

8002285

8002286

8002289

1602202C

1602204C

NUMBER	PRODUCT NAME	PRICE
--------	--------------	-------

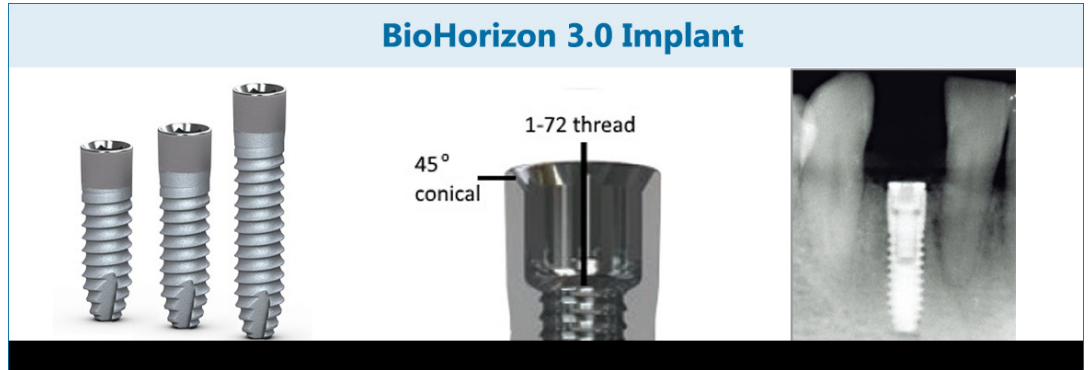

Coming Soon!

BioHorizons Implant Systems

BioHorizons 3.5	Please see Zimmer TSV 3.5mm
BioHorizons 4.5	Please see Zimmer TSV 4.5mm

BIO-LOK Implant Systems

BIO-LOK External Hex	Please see Nobel Branemark RP
----------------------	-------------------------------

Blue Sky Bio Implant Systems

Blue Sky Bio Internal Hex 3.5mm Green	Please see Zimmer TSV 3.5mm
Blue Sky Bio Internal Hex 4.5mm Purple	Please see Zimmer TSV 4.5mm
Blue Sky Bio Tri-Lobe NP	Please see Nobel Tri-Lobe NP
Blue Sky Bio Tri-Lobe RP	Please see Nobel Tri-Lobe RP
Blue Sky Bio Tri-Lobe WP	Please see Nobel Tri-Lobe WP
Blue Sky Bio Tri-Lobe 6.0	Please see Nobel Tri-Lobe 6.0
Blue Sky Bio MAX	Please see Nobel Active/Conical NP
Blue Sky Bio Three	Please see Astra 3.0mm
Blue Sky Bio CONUS 12 3.5/4.0	Please see Astra Aqua 3.5/4.0mm
Blue Sky Bio CONUS 12 4.5/5.0	Please see Astra Lilac 4.5/5.0mm
Blue Sky Bio One Stage RN (4.1mm)	Please see Straumann Tissue Level RN

NEW

FREE PREAT APP

FOR IOS AND ANDROID DEVICES

Download
for
FREE
in your
device
app store



iOS
Devices



ANDROID
Devices

Submit a photo
of an implant
X-ray and we will
identify it for you!

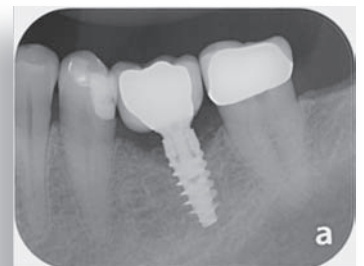



8003200



8003215



8003230



8003235



8003250



8003251



8003262



8003240

NUMBER	PRODUCT NAME	PRICE
--------	--------------	-------

3.3mm Screw Line



8003200	CAMLOG Screw-Line 3.3mm Analog	15.00
8003200-10	CAMLOG Screw-Line 3.3mm Analog (10-Pack)	130.00
8003200-25	CAMLOG Screw-Line 3.3mm Analog (25-Pack)	300.00
8003215	CAMLOG Screw-Line 3.3mm Non-Engaging Plastic UCLA	42.00
8003215-10	CAMLOG Screw-Line 3.3mm Non-Engaging Plastic UCLA (10-Pack)	350.00
8003230	CAMLOG Screw-Line 3.3mm Engaging Verification Cylinder	42.00
8003230-10	CAMLOG Screw-Line 3.3mm Engaging Verification Cylinder (10-Pack)	350.00
8003235	CAMLOG Screw-Line 3.3mm Non-Engaging Verification Cylinder	42.00
8003235-10	CAMLOG Screw-Line 3.3mm Non-Engaging Verification Cylinder (10-Pack)	350.00
8003250	CAMLOG Screw-Line 3.3/3.8/4.3 Titanium Screw	15.00
8003250-10	CAMLOG Screw-Line 3.3/3.8/4.3 Titanium Screw (10-Pack)	130.00
8003251	CAMLOG Screw-Line 3.3/3.8/4.3 Guide Pin 20mm	15.00
8003261	CAMLOG Screw-Line 3.3mm x 4.5mm Engaging Titanium Base	50.00
8003262	CAMLOG Screw-Line 3.3mm x 6mm Engaging Titanium Base	50.00
8003259	CAMLOG Screw-Line 3.3mm x 4.5mm Non-Engaging Titanium Base	50.00
8003240	CAMLOG Screw-Line 3.3mm Blue Light Scan Body	25.00

NUMBER	PRODUCT NAME	PRICE
8003270	CAMLOG Screw-Line 3.3mm Esthetic Abutment 15° Angle, Anterior	105.00
8003271	CAMLOG Screw-Line 3.3mm Esthetic Abutment Straight, Anterior	105.00



8003271



8003300

3.8mm Root, Screw, and Cylinder Line



8003315



8003330



8003335



8003250



8003251



8003361

8003300	CAMLOG Screw-Line 3.8mm Analog	15.00
8003300-10	CAMLOG Screw-Line 3.8mm Analog (10-Pack)	130.00
8003300-25	CAMLOG Screw-Line 3.8mm Analog (25-Pack)	300.00
8003315	CAMLOG Screw-Line 3.8mm Non-Engaging Plastic UCLA	42.00
8003315-10	CAMLOG Screw-Line 3.8mm Non-Engaging Plastic UCLA (10-Pack)	350.00
8003330	CAMLOG Screw-Line 3.8mm Engaging Verification Cylinder	42.00
8003330-10	CAMLOG Screw-Line 3.8mm Engaging Verification Cylinder (10-Pack)	350.00
8003335	CAMLOG Screw-Line 3.8mm Non-Engaging Verification Cylinder	42.00
8003335-10	CAMLOG Screw-Line 3.8mm Non-Engaging Verification Cylinder (10-Pack)	350.00
8003250	CAMLOG Screw-Line 3.3/3.8/4.3 Titanium Screw	15.00
8003250-10	CAMLOG Screw-Line 3.3/3.8/4.3 Titanium Screw (10-Pack)	130.00
8003251	CAMLOG Screw-Line 3.3/3.8/4.3 Guide Pin 20mm	15.00
8003361	CAMLOG Screw-Line 3.8mm x 4.5mm Engaging Titanium Base	50.00



8003362



8003340



8003370



8003371



8003375



8003376



8003377



8003380



8003381

8003385

8003387

8003489

NUMBER	PRODUCT NAME	PRICE
8003362	CAMLOG Screw-Line 3.8mm x 6mm Engaging Titanium Base	50.00
8003359	CAMLOG Screw-Line 3.8mm x 4.5mm Non-Engaging Titanium Base	50.00
8003340	CAMLOG Screw-Line 3.8mm Blue Light Scan Body	25.00
8003370	CAMLOG Screw-Line 3.8mm Esthetic Abutment 15° Angle, Anterior	105.00
8003371	CAMLOG Screw-Line 3.8mm Esthetic Abutment Straight, Anterior	105.00
8003375	CAMLOG Screw-Line 3.8mm Straight Multi-Unit Abutment x 1mm	125.00
8003376	CAMLOG Screw-Line 3.8mm Straight Multi-Unit Abutment x 2mm	125.00
8003377	CAMLOG Screw-Line 3.8mm Straight Multi-Unit Abutment x 3mm	125.00
8003380	CAMLOG Screw-Line 3.8mm 17° Multi-Unit Abutment x 2mm	125.00
8003381	CAMLOG Screw-Line 3.8mm 17° Multi-Unit Abutment x 3mm	125.00
8003385	CAMLOG Screw-Line 3.8mm 30° Multi-Unit Abutment x 3mm	125.00
8003387	CAMLOG Screw-Line 3.8mm 30° Multi-Unit Abutment x 5mm	125.00
8003489	CAMLOG Screw-Line 3.8/4.3mm Multi-Unit Titanium Screw	16.00

4.3mm Root, Screw, and Cylinder Line

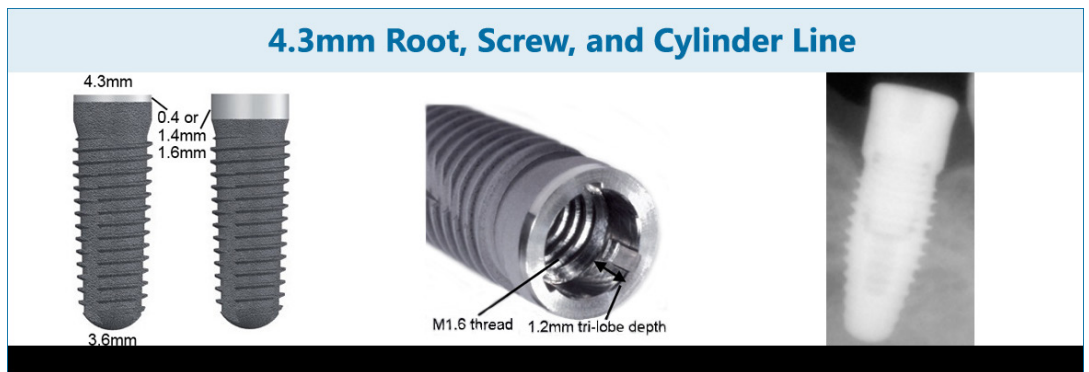

8003400	CAMLOG Screw-Line 4.3mm Analog	15.00
8003400-10	CAMLOG Screw-Line 4.3mm Analog (10-Pack)	130.00

Screw-Line 3.8mm

140

Screw-Line 4.3mm

NUMBER	PRODUCT NAME	PRICE
8003400-25	CAMLOG Screw-Line 4.3mm Analog (25-Pack)	300.00
8003415	CAMLOG Screw-Line 4.3mm Non-Engaging Plastic UCLA	42.00
8003415-10	CAMLOG Screw-Line 4.3mm Non-Engaging Plastic UCLA (10-Pack)	350.00
8003430	CAMLOG Screw-Line 4.3mm Engaging Verification Cylinder	42.00
8003430-10	CAMLOG Screw-Line 4.3mm Engaging Verification Cylinder (10-Pack)	350.00
8003435	CAMLOG Screw-Line 4.3mm Non-Engaging Verification Cylinder	42.00
8003435-10	CAMLOG Screw-Line 4.3mm Non-Engaging Verification Cylinder (10-Pack)	350.00
8003250	CAMLOG Screw-Line 3.3/3.8/4.3 Titanium Screw	15.00
8003250-10	CAMLOG Screw-Line 3.3/3.8/4.3 Titanium Screw (10-Pack)	130.00
8003251	CAMLOG Screw-Line 3.3/3.8/4.3 Guide Pin 20mm	15.00
8003461	CAMLOG Screw-Line 4.3mm x 4.5mm Engaging Titanium Base	50.00
8003462	CAMLOG Screw-Line 4.3mm x 6mm Engaging Titanium Base	50.00
8003459	CAMLOG Screw-Line 4.3mm x 4.5mm Non-Engaging Titanium Base	50.00
8003440	CAMLOG Screw-Line 4.3mm Blue Light Scan Body	25.00
8003470	CAMLOG Screw-Line 4.3mm Esthetic Abutment 15° Angle, Anterior	105.00
8003471	CAMLOG Screw-Line 4.3mm Esthetic Abutment Straight, Anterior	105.00
8003472	CAMLOG Screw-Line 4.3mm Esthetic Abutment 15° Angle, Posterior	105.00
8003473	CAMLOG Screw-Line 4.3mm Esthetic Abutment Straight, Posterior	105.00
8003475	CAMLOG Screw-Line 4.3mm Straight Multi-Unit Abutment x 1mm	125.00
8003476	CAMLOG Screw-Line 4.3mm Straight Multi-Unit Abutment x 2mm	125.00



8003415



8003430



8003435



8003250



8003462



8003440



8003470



8003471



8003477



8003479



8003481



8003487



8003489



8003500



8003515



8003530

NUMBER	PRODUCT NAME	PRICE
8003477	CAMLOG Screw-Line 4.3mm Straight Multi-Unit Abutment x 3mm	125.00
8003479	CAMLOG Screw-Line 4.3mm Straight Multi-Unit Abutment x 5mm	125.00
8003480	CAMLOG Screw-Line 4.3mm 17° Multi-Unit Abutment x 2mm	125.00
8003481	CAMLOG Screw-Line 4.3mm 17° Multi-Unit Abutment x 3mm	125.00
8003483	CAMLOG Screw-Line 4.3mm 17° Multi-Unit Abutment x 5mm	125.00
8003485	CAMLOG Screw-Line 4.3mm 30° Multi-Unit Abutment x 3mm	125.00
8003487	CAMLOG Screw-Line 4.3mm 30° Multi-Unit Abutment x 5mm	125.00
8003489	CAMLOG Screw-Line 3.8/4.3mm Multi-Unit Titanium Screw	16.00

5.0mm Root, Screw, and Cylinder Line



8003500	CAMLOG Screw-Line 5.0mm Analog	15.00
8003500-10	CAMLOG Screw-Line 5.0mm Analog (10-Pack)	130.00
8003500-25	CAMLOG Screw-Line 5.0mm Analog (25-Pack)	300.00
8003515	CAMLOG Screw-Line 5.0mm Non-Engaging Plastic UCLA	42.00
8003515-10	CAMLOG Screw-Line 5.0mm Non-Engaging Plastic UCLA (10-Pack)	350.00
8003530	CAMLOG Screw-Line 5.0mm Engaging Verification Cylinder	42.00
8003530-10	CAMLOG Screw-Line 5.0mm Engaging Verification Cylinder (10-Pack)	350.00

NUMBER	PRODUCT NAME	PRICE
8003535	CAMLOG Screw-Line 5.0mm Non-Engaging Verification Cylinder	42.00
8003535-10	CAMLOG Screw-Line 5.0mm Non-Engaging Verification Cylinder (10-Pack)	350.00
8003551	CAMLOG Screw-Line 5.0/6.0 Guide Pin 20mm	15.00
8003555	CAMLOG Screw-Line 5.0/6.0 Titanium Screw	15.00
8003555-10	CAMLOG Screw-Line 5.0/6.0 Titanium Screw (10-Pack)	130.00
8003561	CAMLOG Screw-Line 5.0mm x 4.5mm Engaging Titanium Base	50.00
8003562	CAMLOG Screw-Line 5.0mm x 6mm Engaging Titanium Base	50.00
8003559	CAMLOG Screw-Line 5.0mm x 4.5mm Non-Engaging Titanium Base	50.00
8003540	CAMLOG Screw-Line 5.0mm Blue Light Scan Body	25.00
8003571	CAMLOG Screw-Line 5.0mm Esthetic Abutment 15° Angle, Posterior	105.00
8003573	CAMLOG Screw-Line 5.0mm Esthetic Abutment Straight, Posterior	105.00
8003575	CAMLOG Screw-Line 5.0mm Straight Multi-Unit Abutment x 1mm	125.00
8003576	CAMLOG Screw-Line 5.0mm Straight Multi-Unit Abutment x 2mm	125.00
8003577	CAMLOG Screw-Line 5.0mm Straight Multi-Unit Abutment x 3mm	125.00



8003535



8003551



8003555



8003561



8003559



8003540



8003573



8003577



8003600



8003615



8003630



8003635



8003661



8003662



8003659



8003640

NUMBER	PRODUCT NAME	PRICE
--------	--------------	-------

6.0mm Root, Screw, and Cylinder Line



8003600	CAMLOG Screw-Line 6.0mm Analog	15.00
8003600-10	CAMLOG Screw-Line 6.0mm Analog (10-Pack)	130.00
8003600-25	CAMLOG Screw-Line 6.0mm Analog (25-Pack)	300.00
8003615	CAMLOG Screw-Line 6.0mm Non-Engaging Plastic UCLA	42.00
8003615-10	CAMLOG Screw-Line 6.0mm Non-Engaging Plastic UCLA (10-Pack)	350.00
8003630	CAMLOG Screw-Line 6.0mm Engaging Verification Cylinder	42.00
8003630-10	CAMLOG Screw-Line 6.0mm Engaging Verification Cylinder (10-Pack)	350.00
8003635	CAMLOG Screw-Line 6.0mm Non-Engaging Verification Cylinder	42.00
8003635-10	CAMLOG Screw-Line 6.0mm Non-Engaging Verification Cylinder (10-Pack)	350.00
8003661	CAMLOG Screw-Line 6.0mm x 4.5mm Engaging Titanium Base	50.00
8003662	CAMLOG Screw-Line 6.0mm x 6mm Engaging Titanium Base	50.00
8003659	CAMLOG Screw-Line 6.0mm x 4.5mm Non-Engaging Titanium Base	50.00
8003640	CAMLOG Screw-Line 6.0mm Blue Light Scan Body	25.00

Glidewell Laboratories Implant Systems

Glidewell Inclusive 3.5mm	Please see Zimmer TSV 3.5mm
Glidewell Inclusive 4.5mm	Please see Zimmer TSV 4.5mm
Glidewell Hahn Tapered 3.0	Please see Nobel Tri-Active/Conical 3.0
Glidewell Hahn Tapered 3.5/4.3	Please see Nobel Tri-Active/Conical NP
Glidewell Hahn Tapered 5.0	Please see Nobel Tri-Active/Conical RP
Glidewell Hahn Tapered 7.0	Please see Nobel Tri-Active/Conical WP

NUMBER	PRODUCT NAME	PRICE
GS II Mini 3.5mm		
9005100	Hiossen HG Mini Analog	15.00
9005100-10	Hiossen HG Mini Analog (10-Pack)	130.00
9005100-25	Hiossen HG Mini Analog (25-Pack)	300.00
9005030	Hiossen HG Mini Engaging Verification Cylinder	42.00
9005030-10	Hiossen HG Mini Engaging Verification Cylinder (10-Pack)	350.00
9005035	Hiossen HG Mini Non-Engaging Verification Cylinder	42.00
9005035-10	Hiossen HG Mini Non-Engaging Verification Cylinder (10-Pack)	350.00
9005050	Hiossen HG Mini Titanium Screw	15.00
9005050-10	Hiossen HG Mini Titanium Screw (10-Pack)	130.00
9005051	Hiossen HG Mini Guide Pin 20mm	15.00
8005059	Hiossen HG Mini x 4.5mm Non-Engaging Titanium Base	50.00
8005061	Hiossen HG Mini X 4.5mm Titanium Base	50.00
8005062	Hiossen HG Mini X 6mm Titanium Base	50.00
8005040	Hiossen HG Mini Blue Light Scan Body	25.00
8005075	Hiossen HG Mini Straight Multi-Unit Abutment x 1.5mm	125.00
8005076	Hiossen HG Mini Straight Multi-Unit Abutment x 2.5mm	125.00



9005100



9005030



9005035



9005050



8005051



8005061



8005059



8005076



8005077



8005081



8005085



8005010



9005000



9005130



9005135



8005150

NUMBER	PRODUCT NAME	PRICE
8005077	Hiossen HG Mini Straight Multi-Unit Abutment x 3.5mm	125.00
8005080	Hiossen HG Mini 17° Multi-Unit Abutment x 2.5mm	125.00
8005081	Hiossen HG Mini 17° Multi-Unit Abutment x 3.5mm	125.00
8005085	Hiossen HG Mini 30° Multi-Unit Abutment x 3.5mm	125.00
8005086	Hiossen HG Mini 30° Multi-Unit Abutment x 4.5mm	125.00
8005010	Hiossen HG Mini Engaging Plastic UCLA	42.00
8005015	Hiossen HG Non-Mini Engaging Plastic UCLA	42.00

GS II Standard 4.0/4.5/5.0mm

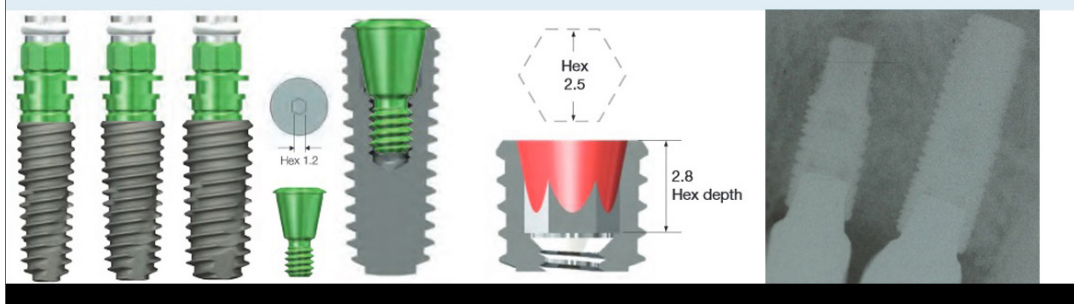

9005000	Hiossen HG Standard Analog	15.00
9005000-10	Hiossen HG Standard Analog (10-Pack)	130.00
9005000-25	Hiossen HG Standard Analog (25-Pack)	300.00
9005130	Hiossen HG Standard Engaging Verification Cylinder	42.00
9005130-10	Hiossen HG Standard Engaging Verification Cylinder (10-Pack)	350.00
9005135	Hiossen HG Standard Non-Engaging Verification Cylinder	42.00
9005135-10	Hiossen HG Standard Non-Engaging Verification Cylinder (10-Pack)	350.00
9005150	Hiossen HG Standard Titanium Screw	15.00

NUMBER	PRODUCT NAME	PRICE
9005150-10	Hiossen HG Standard Titanium Screw (10-Pack)	130.00
9005151	Hiossen HG Standard Guide Pin	15.00
8005159	Hiossen HG Standard x 4.5mm Non-Engaging Titanium Base	50.00
8005161	Hiossen HG Standard Titanium Base x 4.5mm	50.00
8005162	Hiossen HG Standard Titanium Base x 6mm	50.00
8005140	Hiossen HG Standard Blue Light Scan Body	25.00
8005175	Hiossen HG Standard Straight Multi-Unit Abutment x 1.5mm	125.00
8005176	Hiossen HG Standard Straight Multi-Unit Abutment x 2.5mm	125.00
8005177	Hiossen HG Standard Straight Multi-Unit Abutment x 3.5mm	125.00
8005178	Hiossen HG Standard Straight Multi-Unit Abutment x 4.5mm	125.00
8005180	Hiossen HG Standard 17° Multi-Unit Abutment x 2.5mm	125.00
8005181	Hiossen HG Standard 17° Multi-Unit Abutment x 3.5mm	125.00
8005185	Hiossen HG Standard 30° Multi-Unit Abutment x 3.5mm	125.00
8005186	Hiossen HG Standard 30° Multi-Unit Abutment x 4.5mm	125.00
8005110	Hiossen HG Standard Engaging Plastic UCLA	42.00
8005115	Hiossen HG Standard Non-Engaging Plastic UCLA	42.00



8005151



8005159



8005140



8005175



8005176



8005177



8005178



8005180

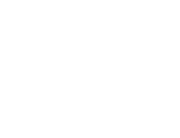

8005181

8005185

8005186

8005110

8005115

Hiossen Implant Systems

Hiossen Plus Wide 5.1mm
Hiossen Regular 4.1mm
Hiossen SS Regular 4.8mm

Please see Nobel Branemark WP
Please see Nobel Branemark RP
Please see Straumann Tissue Level RN



8003200



8003215



8003230



8003235



8003250



8003251



8003262



8003240

NUMBER	PRODUCT NAME	PRICE
--------	--------------	-------

Hi-Tec Implant Systems

Hi-Tec Tapered 3.5mm	Please see Zimmer TSV 3.5mm
Hi-Tec Tapered 4.5mm	Please see Zimmer TSV 4.5mm
Hi-Tec Vision 3.5mm	Please see Nobel Tri-Lobe NP
Hi-Tec Vision 4.3mm	Please see Nobel Tri-Lobe RP
Hi-Tec Vision 5.0mm	Please see Nobel Tri-Lobe WP
Hi-Tec Logic 3.5mm	Please see Nobel Tri-Active/Conical NP
Hi-Tec Logic 4.3/5.0mm	Please see Nobel Tri-Active/Conical RP
Hi-Tec Tapered Tite Fit 4.8	Please see Straumann Tissue Level RN
Hi-Tec Implex / Summitt 4.1mm	Please see Nobel Branemark RP

Imtec Implant Systems

Imtec 3.40 / 3.75 / 4.0 External Hex	Please see Nobel Branemark RP
--------------------------------------	-------------------------------

IMZ Implant Systems

IMZ 3.3 / 4.0 External Hex	Please see Nobel Branemark RP
Innova Endopore 4.1mm	Please see Nobel Branemark RP

LEGACY 2/3/4 3.2mm (3.0mm platform)

Coming Soon!

Implant Direct Implant Systems

Implant Direct InterActive NP	Please see Nobel Tri-Active/Conical NP
Implant Direct InterActive RP	Please see Nobel Tri-Active/Conical RP
Implant Direct Legacy 3.5mm	Please see Zimmer TSV 3.5mm
Implant Direct Legacy 4.5mm	Please see Zimmer TSV 4.5mm
Implant Direct Legacy 5.7mm	Please see Zimmer TSV 5.7mm
Implant Direct RePlant / RePlus / ReActive NP	Please see Nobel Tri-Lobe NP
Implant Direct RePlant / RePlus / ReActive RP	Please see Nobel Tri-Lobe RP
Implant Direct RePlant / RePlus / ReActive WP	Please see Nobel Tri-Lobe WP
Implant Direct SwishPlant/SwishPlus (4.8mmD)	Please see Straumann Tissue Level RN

Lifecore Implant Systems

Lifecore Stage One 3.3/4.1/4.8mm (RDS)	Please see Straumann Tissue Level RN
--	--------------------------------------

Hi-Tec

Imtec

IMZ

148

Legacy 3.0

Implant Direct

Lifecore

NUMBER	PRODUCT NAME	PRICE
Megagen Anyridge		
9004400	MegaGen Anyridge Analog	15.00
9004400-10	MegaGen Anyridge Analog (10-Pack)	130.00
9004400-25	MegaGen Anyridge Analog (25-Pack)	300.00
8004410	MegaGen AnyRidge Engaging Plastic UCLA	42.00
8004410-10	MegaGen AnyRidge Engaging Plastic UCLA (10-Pack)	350.00
8004415	MegaGen AnyRidge Non-Engaging Plastic UCLA	42.00
8004415-10	MegaGen AnyRidge Non-Engaging Plastic UCLA (10-Pack)	350.00
9004430	MegaGen Anyridge Engaging Verification Cylinder	42.00
9004430-10	MegaGen Anyridge Engaging Verification Cylinder (10-Pack)	350.00
9004435	MegaGen Anyridge Non-Engaging Verification Cylinder	42.00
9004435-10	MegaGen Anyridge Non-Engaging Verification Cylinder (10-Pack)	350.00
9004450	MegaGen Anyridge Titanium Screw	15.00
9004450-10	MegaGen Anyridge Titanium Screw (10-Pack)	130.00
9004451	MegaGen Anyridge Guide Pin 20mm	15.00
8004461	MegaGen Anyridge Engaging Titanium Base	50.00



9004400



8004410



8004415



9004430



9004435



9004450



9004451



8004461

Implants
MEGAGEN



8004459



8004440



8004470



8004471



8004472



8004476



8004480



8004488

NUMBER	PRODUCT NAME	PRICE
8004459	MegaGen Anyridge Non-Engaging Titanium Base	50.00
8004440	MegaGen Anyridge Blue Light Scan Body	25.00
8004470	MegaGen Anyridge Esthetic Abutment 15° Anterior	105.00
8004471	MegaGen Anyridge Esthetic Abutment Straight Anterior	105.00
8004472	MegaGen Anyridge Esthetic Abutment 15° Angle, Posterior	105.00
8004473	MegaGen Anyridge Esthetic Abutment Straight, Posterior	105.00
8004475	MegaGen Anyridge Straight Multi-Unit Abutment x 2mm	125.00
8004476	MegaGen Anyridge Straight Multi-Unit Abutment x 3mm	125.00
8004477	MegaGen Anyridge Straight Multi-Unit Abutment x 4mm	125.00
8004478	MegaGen Anyridge Straight Multi-Unit Abutment x 5mm	125.00
8004480	MegaGen Anyridge 17° Multi-Unit Abutment x 3.5mm	125.00
8004481	MegaGen Anyridge 17° Multi-Unit Abutment x 4.5mm	125.00
8004482	MegaGen Anyridge 17° Multi-Unit Abutment x 5.5mm	125.00
8004482	MegaGen Anyridge 17° Multi-Unit Abutment x 5.5mm	125.00
8004485	MegaGen Anyridge 30° Multi-Unit Abutment x 3.5mm	125.00
8004486	MegaGen Anyridge 30° Multi-Unit Abutment x 4.5mm	125.00
8004487	MegaGen Anyridge 30° Multi-Unit Abutment x 5.5mm	125.00
8004488	MegaGen Anyridge 30° Multi-Unit Abutment x 6.5mm	125.00

MegaGen Implant Systems

MegaGen ExFeel External Hex
MegaGen ExFeel 4.8

Please see Nobel Branemark RP
Please see Straumann Tissue Level RN

NUMBER	PRODUCT NAME	PRICE
MIS Implant Systems		
MIS C4 3.75/4.20mm		Please see Zimmer TSV 3.5mm
MIS SEVEN 3.75/4.20mm		Please see Zimmer TSV 3.5mm
MIS Lance External Hex 4.1mm		Please see Nobel Branemark RP
MIS Mistral Internal Morse Taper One Stage RN		Please see Straumann Tissue Level RN

Neoss Regular Platform 3.5 / 4.0 / 4.5 / 5.0 / 5.5mm

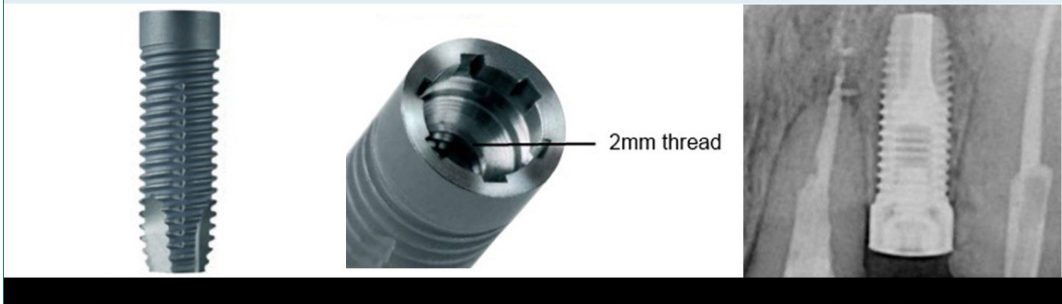

8004175	Neoss 3.5-6.0mm Straight Multi-Unit Abutment x 1mm	125.00
8004176	Neoss 3.5-6.0mm Straight Multi-Unit Abutment x 2mm	125.00
8004177	Neoss 3.5-6.0mm Straight Multi-Unit Abutment x 3mm	125.00
8004178	Neoss 3.5-6.0mm Straight Multi-Unit Abutment x 4mm	125.00



8004175



8004176



8004177



8004178



9004700



8004710

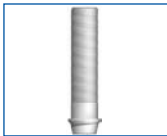

8004715



8004730



8004735



8004750



8004751



8004740

NUMBER	PRODUCT NAME	PRICE
--------	--------------	-------

Active / Conical Connection 3.0mm

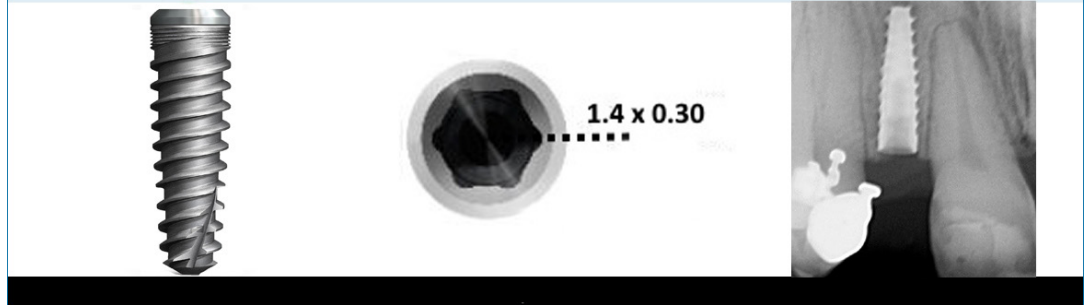

9004700	Nobel Active/Conical 3.0mm Analog	15.00
9004700-10	Nobel Active/Conical 3.0mm Analog (10-Pack)	130.00
9004700-25	Nobel Active/Conical 3.0mm Analog (25-Pack)	300.00
8004710	Nobel Active/Conical 3.0mm Engaging Plastic UCLA	42.00
8004715	Nobel Active/Conical 3.0mm Non-Engaging Plastic UCLA	42.00
8004730	Nobel Active/Conical 3.0mm Engaging Verification Cylinder	42.00
8004730-10	Nobel Active/Conical 3.0mm Engaging Verification Cylinder (10-Pack)	350.00
8004735	Nobel Active/Conical 3.0mm Non-Engaging Verification Cylinder	42.00
8004735-10	Nobel Active/Conical 3.0mm Non-Engaging Verification Cylinder (10-Pack)	350.00
8004750	Nobel Active/Conical 3.0mm Titanium Screw	15.00
8004750-10	Nobel Active/Conical 3.0mm Titanium Screw (10-Pack)	130.00
8004751	Nobel Active/Conical 3.0mm Long Guide Pin	15.00
8004762	Nobel Active/Conical 3.0 x 6mm Engaging Titanium Base	50.00
8004759	Nobel Active/Conical 3.0 x 4.5mm Non-Engaging Titanium Base	50.00
8004740	Nobel Active/Conical 3.0mm Blue Light Scan Body	25.00

NUMBER	PRODUCT NAME	PRICE
8004770	Nobel Active/Conical 3.0mm Esthetic Abutment 15° Anterior	105.00
8004771	Nobel Active/Conical 3.0mm Esthetic Abutment Straight Anterior	105.00
8004776	Nobel Active/Conical 3.0mm Straight Multi-Unit Abutment x 2	125.00
8004786	Nobel Active/Conical 3.0mm Straight Multi-Unit Abutment x 2.5mm	125.00
8004787	Nobel Active/Conical 3.0mm Straight Multi-Unit Abutment x 3.5mm	125.00
8004701	Nobel Active/Conical 3.0mm Open Tray Impression Coping	40.00
8004704	Nobel Active/Conical 3.0mm Closed Tray Impression Coping	40.00



8004770



8004771



8004776



8004787



8004701



8004704



9000800



8000815

Active / Conical Connection NP 3.5mm

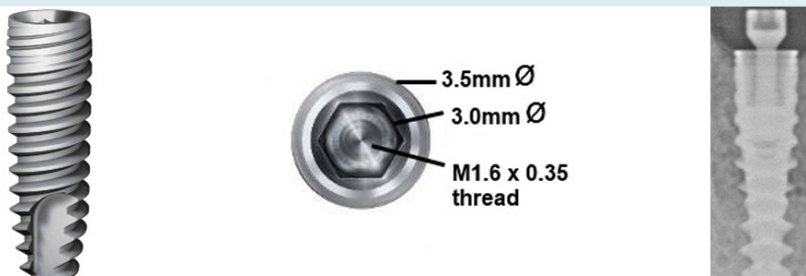

9000800	Nobel Active/Conical NP Analog	15.00
9000800-10	Nobel Active/Conical NP Analog (10-Pack)	130.00
9000800-25	Nobel Active/Conical NP Analog (25-Pack)	300.00
8000810	Nobel Active/Conical NP Engaging Plastic UCLA	42.00
8000810-10	Nobel Active/Conical NP Engaging Plastic UCLA (10-Pack)	350.00
8000815	Nobel Active/Conical NP Non-Engaging Plastic UCLA	42.00
8000815-10	Nobel Active/Conical NP Non-Engaging Plastic UCLA (10-Pack)	350.00
8000825	Nobel Active/Conical NP Engaging Gold/Plastic UCLA	170.00



9000830



9000835



9000850



9000851



8000861



8000859



8000840



8000870

NUMBER	PRODUCT NAME	PRICE
8000820	Nobel Active/Conical NP Non-Engaging Gold Plastic UCLA	170.00
9000830	Nobel Active/Conical NP Engaging Verification Cylinder	42.00
9000830-10	Nobel Active/Conical NP Engaging Verification Cylinder (10-Pack)	350.00
9000835	Nobel Active/Conical NP Non-Engaging Verification Cylinder	42.00
9000835-10	Nobel Active/Conical NP Non-Engaging Verification Cylinder (10-Pack)	350.00
9000850	Nobel Active/Conical NP Titanium Screw	15.00
9000850-10	Nobel Active/Conical NP Titanium Screw (10-Pack)	130.00
9000851	Nobel Active/Conical NP Guide Pin 20mm	15.00
8000861	Nobel Active/Conical NP x 4.5mm Engaging Titanium Base	50.00
8000862	Nobel Active/Conical NP x 6mm Engaging Titanium Base	50.00
8000859	Nobel Active/Conical NP x 4.5mm Non-Engaging Titanium Base	50.00
8000840	Nobel Active/Conical NP Blue Light Scan Body	25.00
8000870	Nobel Active/Conical NP Esthetic Abutment 15° Angle, Anterior	105.00
8000871	Nobel Active/Conical NP Esthetic Abutment Straight, Anterior	105.00
8000875	Nobel Active/Conical NP Straight Multi-Unit Abutment x 1.5mm	125.00
8000876	Nobel Active/Conical NP Straight Multi-Unit Abutment x 2.5mm	125.00
8000877	Nobel Active/Conical NP Straight Multi-Unit Abutment x 3.5mm	125.00
8000880	Nobel Active/Conical NP 17° Multi-Unit Abutment x 2.5mm	125.00
8000881	Nobel Active/Conical NP 17° Multi-Unit Abutment x 3.5mm	125.00
8000885	Nobel Active/Conical NP 30° Multi-Unit Abutment x 3.5mm	125.00

NUMBER	PRODUCT NAME	PRICE
8000886	Nobel Active/Conical NP 30° Multi-Unit Abutment x 4.5mm	125.00
8000889	Nobel Active/Conical NP Multi-Unit Prosthetic Screw	16.00
1608001C	Clix Complete Ball Abutment Nobel Active/Conical NP x 1mm	95.00
1608002C	Clix Complete Ball Abutment Nobel Active/Conical NP x 2mm	95.00
1608003C	Clix Complete Ball Abutment Nobel Active/Conical NP x 3mm	95.00
1608004C	Clix Complete Ball Abutment Nobel Active/Conical NP x 4mm	95.00
1608005C	Clix Complete Ball Abutment Nobel Active/Conical NP x 5mm	95.00
1608006C	Clix Complete Ball Abutment Nobel Active/Conical NP x 6mm	95.00
8000801	Nobel Active/Conical NP Open Tray Impression Coping	40.00
8000804	Nobel Active/Conical NP Closed Tray Impression Coping	40.00



8000886



8000889



1608001C



1608003C



8000801



8000804



9000900



8000910

Active / Conical Connection RP 4.3/5.0mm

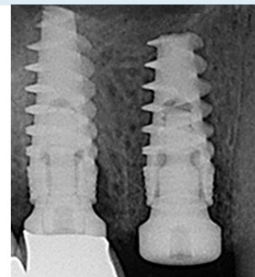
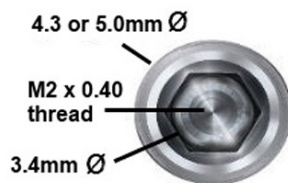

9000900	Nobel Active/Conical RP Analog	15.00
9000900-10	Nobel Active/Conical RP Analog (10-Pack)	130.00
9000900-25	Nobel Active/Conical RP Analog (25-Pack)	300.00
8000910	Nobel Active/Conical RP Engaging Plastic UCLA	42.00
8000910-10	Nobel Active/Conical RP Engaging Plastic UCLA (10-Pack)	350.00



8000915



9000930



9000935



9000950



9000951



8000961



8000940



8000971

NUMBER	PRODUCT NAME	PRICE
8000915	Nobel Active/Conical RP Non-Engaging Plastic UCLA	42.00
8000915-10	Nobel Active/Conical RP Non-Engaging Plastic UCLA (10-Pack)	350.00
8000920	Nobel Active/Conical RP Engaging Gold/Plastic UCLA	170.00
8000925	Nobel Active/Conical RP Non-Engaging Gold Plastic UCLA	170.00
9000930	Nobel Active/Conical RP Engaging Verification Cylinder	42.00
9000930-10	Nobel Active/Conical RP Engaging Verification Cylinder (10-Pack)	350.00
9000935	Nobel Active/Conical RP Non-Engaging Verification Cylinder	42.00
9000935-10	Nobel Active/Conical RP Non-Engaging Verification Cylinder (10-Pack)	350.00
9000950	Nobel Active/Conical RP Titanium Screw	15.00
9000950-10	Nobel Active/Conical RP Titanium Screw (10-Pack)	130.00
9000951	Nobel Active/Conical RP Guide Pin 20mm	15.00
8000961	Nobel Active/Conical RP x 4.5mm Engaging Titanium Base	50.00
8000962	Nobel Active/Conical RP x 6mm Engaging Titanium Base	50.00
8000959	Nobel Active/Conical RP x 4.5mm Non-Engaging Titanium Base	50.00
8000940	Nobel Active/Conical RP Blue Light Scan Body	25.00
8000970	Nobel Active/Conical RP Esthetic Abutment 15° Angle, Anterior	105.00
8000971	Nobel Active/Conical RP Esthetic Abutment Straight, Anterior	105.00
8000972	Nobel Active/Conical RP Esthetic Abutment 15° Angle, Posterior	105.00
8000973	Nobel Active/Conical RP Esthetic Abutment Straight, Posterior	105.00
8000975	Nobel Active/Conical RP Straight Multi-Unit Abutment x 1.5mm	125.00

NUMBER	PRODUCT NAME	PRICE
8000976	Nobel Active/Conical RP Straight Multi-Unit Abutment x 2.5mm	125.00
8000977	Nobel Active/Conical RP Straight Multi-Unit Abutment x 3.5mm	125.00
8000978	Nobel Active/Conical RP Straight Multi-Unit Abutment x 4.5mm	125.00
8000980	Nobel Active/Conical RP 17° Multi-Unit Abutment x 2.5mm	125.00
8000981	Nobel Active/Conical RP 17° Multi-Unit Abutment x 3.5mm	125.00
8000985	Nobel Active/Conical RP 30° Multi-Unit Abutment x 3.5mm	125.00
8000986	Nobel Active/Conical RP 30° Multi-Unit Abutment x 4.5mm	125.00
8000989	Nobel Active/Conical RP Multi-Unit Titanium Screw	16.00
1600901C	Clix Complete Ball Abutment Nobel Active/Conical RP x 1mm	95.00
1600902C	Clix Complete Ball Abutment Nobel Active/Conical RP x 2mm	95.00
1600903C	Clix Complete Ball Abutment Nobel Active/Conical RP x 3mm	95.00
1600904C	Clix Complete Ball Abutment Nobel Active/Conical RP x 4mm	95.00
1600905C	Clix Complete Ball Abutment Nobel Active/Conical RP x 5mm	95.00
1600906C	Clix Complete Ball Abutment Nobel Active/Conical RP x 6mm	95.00
8000901	Nobel Active/Conical RP Open Tray Impression Coping	40.00
8000904	Nobel Active/Conical RP Closed Tray Impression Coping	40.00



9000976



8000978



8000981



8000985



1600901C



1600905C



8000901



8000904



9004900



8004904



8004910



8004920



8004930



8004935



8004962



8004901

NUMBER	PRODUCT NAME	PRICE
--------	--------------	-------

Active / Conical Connection WP

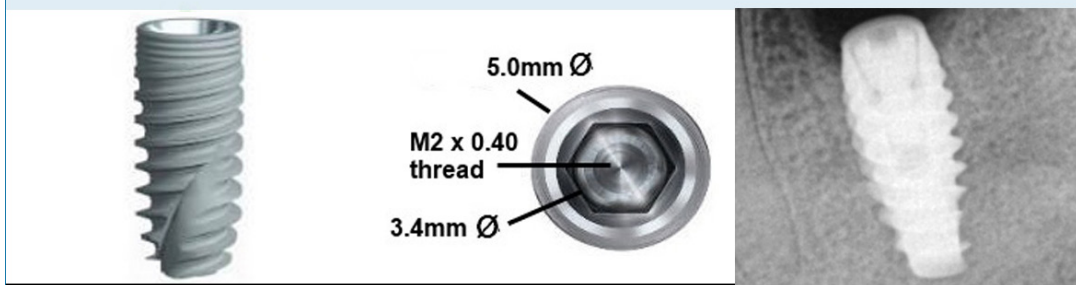

9004900	Nobel Active/Conical WP Analog	15.00
9004900-10	Nobel Active/Conical WP Analog (10-Pack)	130.00
9004900-25	Nobel Active/Conical WP Analog (25-Pack)	300.00
8004904	Nobel Active/Conical WP Closed Tray Impression Coping	40.00
8004910	Nobel Active/Conical WP Engaging Plastic UCLA	46.00
8004910-10	Nobel Active/Conical WP Engaging Plastic UCLA (10-Pack)	350.00
8004920	Nobel Active/Conical WP Engaging Gold/Plastic Abutment..	200.00
8004930	Nobel Active/Conical WP Engaging Verification Cylinder	42.00
8004930-10	Nobel Active/Conical WP Engaging Verification Cylinder (10-Pack)	350.00
8004935	Nobel Active/Conical WP Non-Engaging Verification Cylinder	42.00
8004935-10	Nobel Active/Conical WP Non-Engaging Verification Cylinder (10-Pack)	350.00
8004961	Nobel Active/Conical WP x 4.5mm Titanium Base	50.00
8004962	Nobel Active/Conical WP x 6mm Titanium Base	50.00
8004940	Nobel Active/Conical WP Blue Light Scan Body	25.00
8004901	Nobel Active/Conical WP Open Tray Transfer	40.00

NUMBER	PRODUCT NAME	PRICE
--------	--------------	-------

Branemark RP 3.75/4.1mm



8001000	Branemark RP Analog	15.00
8001000-10	Branemark RP Analog (10-Pack)	130.00
8001000-25	Branemark RP Analog (25-Pack)	300.00
8001010	Branemark RP Engaging Plastic UCLA	42.00
8001010-10	Branemark RP Engaging Plastic UCLA (10-Pack)	350.00
8001015	Branemark RP Non-Engaging Plastic UCLA	42.00
8001015-10	Branemark RP Non-Engaging Plastic UCLA (10-Pack)	350.00
8001020	Branemark RP Engaging Gold/Plastic Abutment	170.00
8001025	Branemark RP Non-Engaging Gold/Plastic Abutment	170.00
8001030	Branemark RP Engaging Verification Cylinder	42.00
8001030-10	Branemark RP Engaging Verification Cylinder (10-Pack)	350.00
8001035	Branemark RP Non-Engaging Verification Cylinder	42.00
8001035-10	Branemark RP Non-Engaging Verification Cylinder (10-Pack)	350.00
8001050	Branemark RP Titanium Screw	15.00
8001050-10	Branemark RP Titanium Screw (10-Pack)	130.00



8001000



8001010



8001015



8001020



8001025



8001030



8001035



8001050



8001051



8001062



8001081

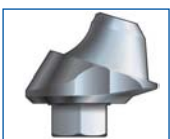

8001085

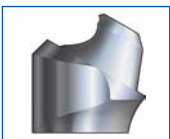

8001091

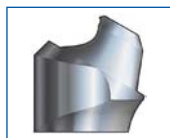

8001092



8001089



1600821C

NUMBER	PRODUCT NAME	PRICE
8001051	Branemark RP Guide Pin 20mm	15.00
8001061	Branemark RP x 4.5mm Engaging Titanium Base	50.00
8001062	Branemark RP x 6mm Engaging Titanium Base	50.00
8001059	Branemark RP x 4.5mm Non-Engaging Titanium Base	50.00
8001081	Branemark RP Straight Multi-Unit Abutment x 1mm	125.00
8001082	Branemark RP Straight Multi-Unit Abutment x 2mm	125.00
8001083	Branemark RP Straight Multi-Unit Abutment x 3mm	125.00
8001084	Branemark RP Straight Multi-Unit Abutment x 5mm	125.00
8001085	Branemark RP 17° Multi-Unit Abutment x 2mm	125.00
8001086	Branemark RP 17° Multi-Unit Abutment x 3mm	125.00
8001087	Branemark RP 17° Multi-Unit Abutment x 4mm	125.00
8001091	Branemark RP 30° Multi-Unit Abutment x 4mm	125.00
8001092	Branemark RP 30° Multi-Unit Abutment x 5mm	125.00
8001089	Branemark RP Multi-Unit Titanium Screw	16.00
1600821C	O-Ring Complete Ball Abutment Branemark RP x 1mm	75.00
1600822C	O-Ring Complete Ball Abutment Branemark RP x 2mm	75.00
1600823C	O-Ring Complete Ball Abutment Branemark RP x 3mm	75.00
1600824C	O-Ring Complete Ball Abutment Branemark RP x 4mm	75.00
1600825C	O-Ring Complete Ball Abutment Branemark RP x 5mm	75.00
1600826C	O-Ring Complete Ball Abutment Branemark RP x 6mm	75.00

NUMBER	PRODUCT NAME	PRICE
--------	--------------	-------

Branemark WP 5.0mm



8002920	Branemark 5.0mm Engaging Gold/Plastic Abutment	165.00
8002925	Branemark 5.0mm Non-Engaging Gold/Plastic Abutment	165.00



Nobel Tri-lobe NP



9000400	Nobel Tri-Lobe NP Analog	15.00
9000400-10	Nobel Tri-Lobe NP Analog (10-Pack)	130.00
9000400-25	Nobel Tri-lobe NP Analog (25-Pack)	300.00
8000401	Nobel Tri-Lobe NP Open-Tray Transfer 3.5mm Ø	30.00
8000404	Nobel Tri-Lobe NP Closed-Tray Transfer 3.5mm Ø	30.00
8000410	Nobel Tri-Lobe NP Engaging Plastic UCLA	42.00
8000410-10	Nobel Tri-Lobe NP Engaging Plastic UCLA (10-Pack)	350.00
8000415	Nobel Tri-Lobe NP Non-Engaging Plastic UCLA	42.00
8000415-10	Nobel Tri-Lobe NP Non-Engaging Plastic UCLA (10-Pack)	350.00





8000425



9000430



9000435



9000450



8000451



8000461



8000440



8000471

NUMBER	PRODUCT NAME	PRICE
8000420	Nobel Tri-Lobe NP Engaging Gold/Plastic Abutment	155.00
8000425	Nobel Tri-Lobe NP Non-Engaging Gold/Plastic Abutment	155.00
9000430	Nobel Tri-Lobe NP Engaging Verification Cylinder	42.00
9000430-10	Nobel Tri-Lobe NP Engaging Verification Cylinder (10-Pack)	350.00
9000435	Nobel Tri-Lobe NP Non-Engaging Verification Cylinder	42.00
9000435-10	Nobel Tri-Lobe NP Non-Engaging Verification Cylinder (10-Pack)	350.00
9000450	Nobel Tri-Lobe NP Titanium Screw	15.00
9000450-10	Nobel Tri-Lobe NP Titanium Screw (10-Pack)	130.00
9000451	Nobel Tri-Lobe NP Guide Pin 20mm	15.00
8000459	Nobel Tri-Lobe NP x 4.5mm Non-Engaging Titanium Base	50.00
8000461	Nobel Tri-Lobe NP x 4.5mm Engaging Titanium Base	50.00
8000462	Nobel Tri-Lobe NP x 6mm Engaging Titanium Base	50.00
8000440	Nobel Tri-Lobe NP Blue Light Lab Scan Body	25.00
8000470	Nobel Tri-Lobe NP Esthetic Abutment 15° Angle, Anterior	105.00
8000471	Nobel Tri-Lobe NP Esthetic Abutment Straight, Anterior	105.00
8000475	Nobel Tri-Lobe NP Straight Multi-Unit Abutment x 1mm	125.00
8000476	Nobel Tri-Lobe NP Straight Multi-Unit Abutment x 2mm	125.00
8000477	Nobel Tri-Lobe NP Straight Multi-Unit Abutment x 3mm	125.00
8000480	Nobel Tri-Lobe NP 17° Multi-Unit Abutment x 2mm	125.00
8000481	Nobel Tri-Lobe NP 17° Multi-Unit Abutment x 3mm	125.00

NUMBER	PRODUCT NAME	PRICE
8000489	Nobel Tri-Lobe NP Multi-Unit Titanium Screw	16.00
8000490	Nobel Tri-Lobe NP Snappy Abutment 4.0 Analog	20.00
8000491	Nobel Tri-Lobe NP Snappy Abutment 5.5 Analog	20.00
1600400C	Clix Complete Ball Abutment Nobel Tri-Lobe NP x 0mm	95.00
1600401C	Clix Complete Ball Abutment Nobel Tri-Lobe NP x 1mm	95.00
1600402C	Clix Complete Ball Abutment Nobel Tri-Lobe NP x 2mm	95.00
1600403C	Clix Complete Ball Abutment Nobel Tri-Lobe NP x 3mm	95.00
1600404C	Clix Complete Ball Abutment Nobel Tri-Lobe NP x 4mm	95.00
1600405C	Clix Complete Ball Abutment Nobel Tri-Lobe NP x 5mm	95.00
1600406C	Clix Complete Ball Abutment Nobel Tri-Lobe NP x 6mm	95.00



8000489



9000579

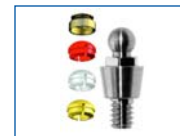

1600402C



1600404C



1600406C



8000589



1600500C



1600506C

Nobel Tri-lobe RP



9000500	Nobel Tri-Lobe RP Analog	15.00
9000500-10	Nobel Tri-Lobe RP Analog (10-Pack)	130.00
9000500-25	Nobel Tri-Lobe RP Analog (25-Pack)	300.00
8000501	Nobel Tri-Lobe RP Open-Tray Transfer 4.3mm Ø	30.00
8000504	Nobel Tri-Lobe RP Closed-Tray Transfer 4.3mm Ø	30.00



8000520



9000530



8000550



8000559



8000562



8000540



8000571



8000572

NUMBER	PRODUCT NAME	PRICE
8000510	Nobel Tri-Lobe RP Engaging Plastic UCLA	42.00
8000510-10	Nobel Tri-Lobe RP Engaging Plastic UCLA (10-Pack)	350.00
8000515	Nobel Tri-Lobe RP Non-Engaging Plastic UCLA	42.00
8000515-10	Nobel Tri-Lobe RP Non-Engaging Plastic UCLA (10-Pack)	350.00
8000520	Nobel Tri-Lobe RP Engaging Gold/Plastic Abutment	160.00
8000525	Nobel Tri-Lobe RP Non-Engaging Gold/Plastic Abutment	160.00
9000530	Nobel Tri-Lobe RP Engaging Verification Cylinder	42.00
9000530-10	Nobel Tri-Lobe RP Engaging Verification Cylinder (10-Pack)	350.00
9000535	Nobel Tri-Lobe RP Non-Engaging Verification Cylinder	42.00
9000535-10	Nobel Tri-Lobe RP Non-Engaging Verification Cylinder (10-Pack)	350.00
9000550	Nobel Tri-Lobe RP/5.0mm/6.0mm Titanium Screw	15.00
9000550-10	Nobel Tri-Lobe RP/5.0mm/6.0mm Titanium Screw (10-Pack)	130.00
9000551	Nobel Tri-Lobe RP/5.0mm/6.0mm Guide Pin 20mm	15.00
8000559	Nobel Tri-Lobe RP x 4.5mm Non-Engaging Titanium Base	50.00
8000561	Nobel Tri-Lobe RP x 4.5mm Engaging Titanium Base	50.00
8000562	Nobel Tri-Lobe RP x 6mm Engaging Titanium Base	50.00
8000540	Nobel Tri-Lobe RP Blue Light Lab Scan Body	25.00
8000570	Nobel Tri-Lobe RP Esthetic Abutment 15° Angle, Anterior	105.00
8000571	Nobel Tri-Lobe RP Esthetic Abutment Straight, Anterior	105.00
8000572	Nobel Tri-Lobe RP Esthetic Abutment 15° Angle, Posterior	105.00

NUMBER	PRODUCT NAME	PRICE
8000573	Nobel Tri-Lobe RP Esthetic Abutment Straight, Posterior	105.00
8000575	Nobel Tri-Lobe RP Straight Multi-Unit Abutment x 1mm	125.00
8000576	Nobel Tri-Lobe RP Straight Multi-Unit Abutment x 2mm	125.00
8000577	Nobel Tri-Lobe RP Straight Multi-Unit Abutment x 3mm	125.00
8000579	Nobel Tri-Lobe RP Straight Multi-Unit Abutment x 5mm	125.00
8000580	Nobel Tri-Lobe RP 17° Multi-Unit Abutment x 2mm	125.00
8000581	Nobel Tri-Lobe RP 17° Multi-Unit Abutment x 3mm	125.00
8000582	Nobel Tri-Lobe RP 17° Multi-Unit Abutment x 4mm	125.00
8000586	Nobel Tri-Lobe RP 30° Multi-Unit Abutment x 4mm	125.00
8000587	Nobel Tri-Lobe RP 30° Multi-Unit Abutment x 5mm	125.00
8000589	Nobel Tri-Lobe RP Multi-Unit Titanium Screw	16.00
8000590	Nobel Tri-lobe RP Snappy Abutment 4.0 Analog	20.00
8000591	Nobel Tri-Lobe RP Snappy Abutment 5.5 Analog	20.00
1600500C	Clix Complete Ball Abutment Nobel Tri-Lobe RP x 0mm	95.00
1600501C	Clix Complete Ball Abutment Nobel Tri-Lobe RP x 1mm	95.00
1600502C	Clix Complete Ball Abutment Nobel Tri-Lobe RP x 2mm	95.00
1600503C	Clix Complete Ball Abutment Nobel Tri-Lobe RP x 3mm	95.00
1600504C	Clix Complete Ball Abutment Nobel Tri-Lobe RP x 4mm	95.00
1600505C	Clix Complete Ball Abutment Nobel Tri-Lobe RP x 5mm	95.00
1600506C	Clix Complete Ball Abutment Nobel Tri-Lobe RP x 6mm	95.00



8000575



9000579



9000580



9000587



8000590



8000589

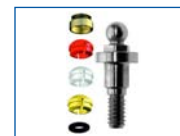

1600500C



1600506C



9000600



8000601



8000610



8000615



8000620



8000630



8000635



8000550

NUMBER	PRODUCT NAME	PRICE
Nobel Tri-lobe WP		
9000600	Nobel Tri-Lobe WP Analog	15.00
9000600-10	Nobel Tri-Lobe WP Analog (10-Pack)	130.00
9000600-25	Nobel Tri-Lobe WP Analog (25-Pack)	300.00
8000601	Nobel Tri-Lobe WP Open-Tray Transfer 5.0mm Ø	30.00
8000604	Nobel Tri-Lobe WP Closed-Tray Transfer 5.0mm Ø	30.00
8000610	Nobel Tri-Lobe WP Engaging Plastic UCLA	42.00
8000610-10	Nobel Tri-Lobe WP Engaging Plastic UCLA (10-Pack)	350.00
8000615	Nobel Tri-Lobe WP Non-Engaging Plastic UCLA	42.00
8000615-10	Nobel Tri-Lobe WP Non-Engaging Plastic UCLA (10-Pack)	350.00
8000620	Nobel Tri-Lobe WP Engaging Gold/Plastic Abutment	175.00
8000625	Nobel Tri-Lobe WP Non-Engaging Gold/Plastic Abutment	175.00
8000630	Nobel Tri-Lobe WP Engaging Verification Cylinder	42.00
8000630-10	Nobel Tri-Lobe WP Engaging Verification Cylinder (10-Pack)	350.00
8000635	Nobel Tri-Lobe WP Non-Engaging Verification Cylinder	42.00
8000635-10	Nobel Tri-Lobe WP Non-Engaging Verification Cylinder (10-Pack)	350.00
8000550	Nobel Tri-Lobe RP/5.0mm/6.0mm Titanium Screw	15.00

NUMBER	PRODUCT NAME	PRICE
8000550-10	Nobel Tri-Lobe RP/5.0mm/6.0mm Titanium Screw (10-Pack)	130.00
8000551	Nobel Tri-Lobe RP/5.0mm/6.0mm Guide Pin 20mm	15.00
8000659	Nobel Tri-Lobe WP x 4.5 Non-Engaging Titanium Base	50.00
8000661	Nobel Tri-Lobe WP x 4.5mm Titanium Base	50.00
8000662	Nobel Tri-Lobe WP x 6mm Titanium Base	50.00
8000640	Nobel Tri-Lobe WP Blue Light Lab Scan Body	25.00
8000670	Nobel Tri-Lobe WP Esthetic Abutment 15° Angle, Anterior	105.00
8000671	Nobel Tri-Lobe WP Esthetic Abutment Straight, Anterior	105.00
8000672	Nobel Tri-Lobe WP Esthetic Abutment 15° Angle, Posterior	105.00
8000673	Nobel Tri-Lobe WP Esthetic Abutment Straight, Posterior	105.00
8000675	Nobel Tri-Lobe WP Straight Multi-Unit Abutment x 1mm	125.00
8000676	Nobel Tri-Lobe WP Straight Multi-Unit Abutment x 2mm	125.00
8000677	Nobel Tri-Lobe WP Straight Multi-Unit Abutment x 3mm	125.00
8000690	Nobel Tri-Lobe WP Snappy Abutment 4.0 Analog	20.00
8000691	Nobel Tri-Lobe WP Snappy Abutment Analog 5.5	20.00
1600601C	Clix Complete Ball Abutment Nobel Tri-Lobe WP x 1mm	95.00
1600602C	Clix Complete Ball Abutment Nobel Tri-Lobe WP x 2mm	95.00
1600603C	Clix Complete Ball Abutment Nobel Tri-Lobe WP x 3mm	95.00
1600604C	Clix Complete Ball Abutment Nobel Tri-Lobe WP x 4mm	95.00
1600605C	Clix Complete Ball Abutment Nobel Tri-Lobe WP x 5mm	95.00



8000551



8000659



8000662



8000670



8000673



8000677



8000691



1600602



9000700



8000710



8000715



8000720



8000725



8000730



8000735



8000550

NUMBER	PRODUCT NAME	PRICE
--------	--------------	-------

Nobel Tri-lobe 6.0mm

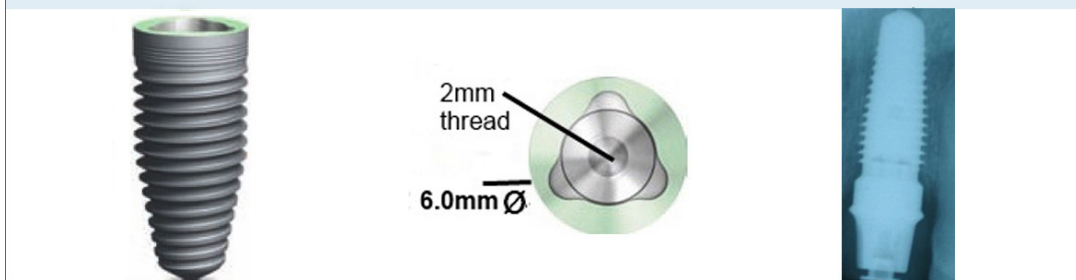

9000700	Nobel Tri-Lobe 6.0mm Analog	15.00
9000700-10	Nobel Tri-Lobe 6.0mm Analog (10-Pack)	130.00
9000700-25	Nobel Tri-Lobe 6.0mm Analog (25-Pack)	300.00
8000710	Nobel Tri-Lobe 6.0mm Engaging Plastic UCLA	42.00
8000710-10	Nobel Tri-Lobe 6.0mm Engaging Plastic UCLA (10-Pack)	350.00
8000715	Nobel Tri-Lobe 6.0mm Non-Engaging Plastic UCLA	42.00
8000715-10	Nobel Tri-Lobe 6.0mm Non-Engaging Plastic UCLA (10-Pack)	350.00
8000720	Nobel Tri-Lobe 6.0mm Engaging Gold/Plastic Abutment	180.00
8000725	Nobel Tri-Lobe 6.0mm Non-Engaging Gold/Plastic Abutment	180.00
8000730	Nobel Tri-Lobe 6.0mm Engaging Verification Cylinder	42.00
8000730-10	Nobel Tri-Lobe 6.0mm Engaging Verification Cylinder (10-Pack)	350.00
8000735	Nobel Tri-Lobe 6.0mm Non-Engaging Verification Cylinder	42.00
8000735-10	Nobel Tri-Lobe 6.0mm Non-Engaging Verification Cylinder (10-Pack)	350.00
8000550	Nobel Tri-Lobe RP/5.0mm/6.0mm Titanium Screw	15.00
8000550-10	Nobel Tri-Lobe RP/5.0mm/6.0mm Titanium Screw (10-Pack)	130.00

NUMBER	PRODUCT NAME	PRICE
8000551	Nobel Tri-Lobe RP/5.0mm/6.0mm Guide Pin 20mm	15.00
8000759	Nobel Tri-Lobe 6.0mm x 4.5mm Non-Engaging Titanium Base	50.00
8000761	Nobel Tri-Lobe 6.0mm x 4.5mm Engaging Titanium Base	50.00
8000762	Nobel Tri-Lobe 6.0mm x 6mm Engaging Titanium Base	50.00
8000740	Nobel Tri-Lobe 6.0mm Blue Light Lab Scan Body	25.00
8000773	Nobel Tri-Lobe 6.0mm Esthetic Abutment Straight, Posterior	105.00
8000790	Nobel Tri-Lobe 6.0mm Snappy Abutment 4.0 Analog	20.00
8000791	Nobel Tri-Lobe 6.0mm Snappy Abutment 5.5 Analog	20.00



8000551



8000759



8000761



8000762



8000740



8000773



8000790



8000791

Nobel Biocare Implant Systems

Steri-Oss Hex Lock 3.8 /4.5mm Please see Nobel Branemark RP

Southern Implant Systems

Southern 12 Degrees 4.3 (3.5mmD)	Please see Nobel Tri-Lobe NP
Southern 12 Degrees 5.0 (4.3mmD)	Please see Nobel Tri-Lobe RP
Southern 12 Degrees 7.0 (5.0mmD)	Please see Nobel Tri-Lobe WP
Southern CoAxis / MAX-IT 4.0 / 5.0mm (4.8mmD)	Please see Straumann Tissue Level RN
Southern CoAxis / MAX-IT 6.0 / (6.5mmD)	Please see Straumann Tissue Level WN
Southern CoAxis TriNeck / TriMax 6.0	Please see Nobel Tri-Lobe 6.0
Southern CoAxis TriNeck / TriMax NP	Please see Nobel Tri-Lobe NP
Southern CoAxis TriNeck / TriMax RP	Please see Nobel Tri-Lobe RP
Southern CoAxis TriNeck / TriMax WP	Please see Nobel Tri-Lobe WP

Sterngold Implant Systems

Sterngold IC 3.3 / 4.1/ 4.8mm Sterngold	Please see Straumann Tissue Level RN
Hex Cylinder 3.3 / 4.0mm Sterngold	Please see Nobel Branemark RP
Hex Screws 3.75 /4.0 /5.0mm	Please see Nobel Branemark RP



9001500



8001510



8001515



9001530



9001535



8001550



9001551



8001559

NUMBER	PRODUCT NAME	PRICE
--------	--------------	-------

Bone Level Narrow Crossfit NC (3.3mmD)

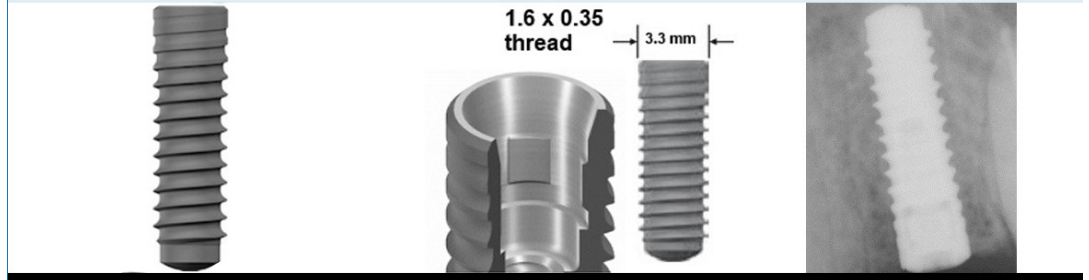

9001500	Straumann Bone Level NC Analog	15.00
9001500-10	Straumann Bone Level NC Analog (10-Pack)	130.00
9001500-25	Straumann Bone Level NC Analog (25-Pack)	300.00
8001510	Straumann Bone Level NC Engaging Plastic UCLA	42.00
8001510-10	Straumann Bone Level NC Engaging Plastic UCLA (10-Pack)	350.00
8001515	Straumann Bone Level NC Non-Engaging Plastic UCLA	42.00
8001515-10	Straumann Bone Level NC Non-Engaging Plastic UCLA (10-Pack)	350.00
9001530	Straumann Bone Level NC Engaging Verification Cylinder	42.00
9001530-10	Straumann Bone Level NC Engaging Verification Cylinder (10-Pack)	350.00
9001535	Straumann Bone Level NC Non-Engaging Verification Cylinder	42.00
9001535-10	Straumann Bone Level NC Non-Engaging Verification Cylinder (10-Pack)	350.00
9001550	Straumann Bone Level NC Titanium Screw	15.00
9001550-10	Straumann Bone Level NC Titanium Screw (10-Pack)	130.00
9001551	Straumann Bone Level NC Guide Pin 20mm	15.00
8001559	Straumann Bone Level NC x 4.5mm Non-Engaging Titanium Base	50.00

NUMBER	PRODUCT NAME	PRICE
8001561	Straumann Bone Level NC x 4.5mm Engaging Titanium Base	50.00
8001562	Straumann Bone Level NC x 6mm Engaging Titanium Base	50.00
8001540	Straumann Bone Level NC Blue Light Scan Body	25.00
8001570	Straumann Bone Level NC Esthetic Abutment 15° Angle, Anterior	105.00
8001571	Straumann Bone Level NC Esthetic Abutment Straight, Anterior	105.00
8001575	Straumann Bone Level NC Straight Multi-Unit Abutment x 1.5mm	125.00
8001576	Straumann Bone Level NC Straight Multi-Unit Abutment x 2.5mm	125.00
8001577	Straumann Bone Level NC Straight Multi-Unit Abutment x 3.5mm	125.00
8001580	Straumann Bone Level NC 17° Multi-Unit Abutment x 2.5mm	125.00
8001581	Straumann Bone Level NC 17° Multi-Unit Abutment x 3.5mm	125.00
8001489	Straumann Bone Level NC/RC Multi-Unit Titanium Screw	16.00
1601500C	Clix Complete Ball Abutment Straumann Bone Level NC x 1mm	95.00
1601501C	Clix Complete Ball Abutment Straumann Bone Level NC x 2mm	95.00
1601502C	Clix Complete Ball Abutment Straumann Bone Level NC x 3mm	95.00
1601503C	Clix Complete Ball Abutment Straumann Bone Level NC x 4mm	95.00
1601504C	Clix Complete Ball Abutment Straumann Bone Level NC x 5mm	95.00



8001561



8001562



8001540



8001570



8001571



8001575



8001576

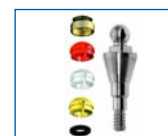

8001577



8001580

8001581

8001489

1601500C

1601501C

1601502C

1601503C

1601504C



9001400



8001410



8001415



9001430



9001435



9001450



9001451



8001459

NUMBER	PRODUCT NAME	PRICE
--------	--------------	-------

Bone Level Regular Crossfit RC (4.1mmD)



9001400	Straumann Bone Level RC Analog	15.00
9001400-10	Straumann Bone Level RC Analog (10-Pack)	130.00
9001400-25	Straumann Bone Level RC Analog (25-Pack)	300.00
8001410	Straumann Bone Level RC Engaging Plastic UCLA	42.00
8001410-10	Straumann Bone Level RC Engaging Plastic UCLA (10-Pack)	350.00
8001415	Straumann Bone Level RC Non-Engaging Plastic UCLA	42.00
8001415-10	Straumann Bone Level RC Non-Engaging Plastic UCLA (10-Pack)	350.00
9001430	Straumann Bone Level RC Engaging Verification Cylinder	42.00
9001430-10	Straumann Bone Level RC Engaging Verification Cylinder (10-Pack)	350.00
9001435	Straumann Bone Level RC Non-Engaging Verification Cylinder	42.00
9001435-10	Straumann Bone Level RC Non-Engaging Verification Cylinder (10-Pack)	350.00
9001450	Straumann Bone Level RC Titanium Screw	15.00
9001450-10	Straumann Bone Level RC Titanium Screw (10-Pack)	130.00
9001451	Straumann Bone Level RC Guide Pin 20mm	15.00
8001459	Straumann Bone Level RC x 4.5mm Non-Engaging Titanium Base	50.00

NUMBER	PRODUCT NAME	PRICE
8001461	Straumann Bone Level RC x 4.5mm Engaging Titanium Base	50.00
8001462	Straumann Bone Level RC x 6mm Engaging Titanium Base	50.00
8001440	Straumann Bone Level RC Blue Light Scan Body	25.00
8001470	Straumann Bone Level RC Esthetic Abutment 15° Angle, Anterior	105.00
8001471	Straumann Bone Level RC Esthetic Abutment Straight, Anterior	105.00
8001472	Straumann Bone Level RC Esthetic Abutment 15° Angle, Posterior	105.00
8001473	Straumann Bone Level RC Esthetic Abutment Straight, Posterior	105.00
8001475	Straumann Bone Level RC Straight Multi-Unit Abutment x 1.5mm	125.00
8001476	Straumann Bone Level RC Straight Multi-Unit Abutment x 2.5mm	125.00
8001477	Straumann Bone Level RC Straight Multi-Unit Abutment x 3.5mm	125.00
8001478	Straumann Bone Level RC Straight Multi-Unit Abutment x 4.5mm	125.00
8001480	Straumann Bone Level RC 17° Multi-Unit Abutment x 2.5mm	125.00
8001481	Straumann Bone Level RC 17° Multi-Unit Abutment x 3.5mm	125.00
8001485	Straumann Bone Level RC 30° Multi-Unit Abutment x 3.5mm	125.00
8001486	Straumann Bone Level RC 30° Multi-Unit Abutment x 4.5mm	125.00
8001489	Straumann Bone Level NC/RC Multi-Unit Titanium Screw	15.00
1601400C	Clix Complete Ball Abutment Straumann Bone Level RC x 1mm	95.00
1601401C	Clix Complete Ball Abutment Straumann Bone Level RC x 2mm	95.00
1601402C	Clix Complete Ball Abutment Straumann Bone Level RC x 3mm	95.00
1601403C	Clix Complete Ball Abutment Straumann Bone Level RC x 4mm	95.00



8001461



8001440



8001470



8001471



8001472



8001473

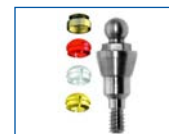

8001475



8001476



8001477



8001478



8001480



8001481



8001485



8001486



8001489



1601400C



1601401C

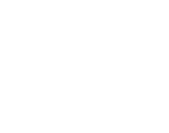

1601402C



1601403C



1601404C



1601405C



8001100



8001150



9001200



8001210

NUMBER	PRODUCT NAME	PRICE
1601404C	Clix Complete Ball Abutment Straumann Bone Level RC x 5mm	95.00
1601405C	Clix Complete Ball Abutment Straumann Bone Level RC x 6mm	95.00

SynOcta (Tissue Level) Standard NN (3.5mmD)

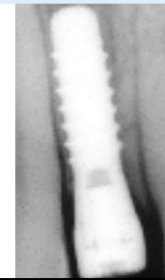
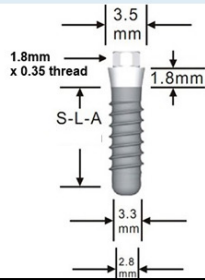

8001100	Straumann Bone Level NN Analog	15.00
8001100-10	Straumann Bone Level NN Analog (10-Pack)	130.00
8001100-25	Straumann Bone Level NN Analog (25-Pack)	300.00
8001150	Straumann Tissue Level NN Titanium Screw	15.00
8001150-10	Straumann Tissue Level NN Titanium Screw (10-Pack)	130.00

SynOcta (Tissue Level) Standard RN (4.8mmD)

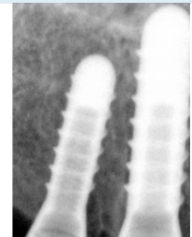
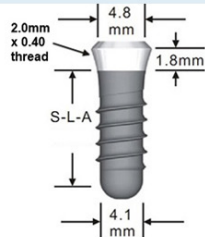

9001200	Straumann Tissue Level RN Analog	15.00
9001200-10	Straumann Tissue Level RN Analog (10-Pack)	130.00
9001200-25	Straumann Tissue Level RN Analog (25-Pack)	300.00
8001210	Straumann Tissue Level RN Non-Engaging Plastic UCLA	42.00

NUMBER	PRODUCT NAME	PRICE
8001210-10	Straumann Tissue Level RN Non-Engaging Plastic UCLA (Pack-10)	350.00
8001220	Straumann Tissue Level RN Engaging Gold/Plastic Abutment	175.00
8001225	Straumann Tissue Level RN Non-Engaging Gold/Plastic Abutment	175.00
8001231	Straumann Tissue Level RN Engaging Verification Cylinder	42.00
8001231-10	Straumann Tissue Level RN Engaging Verification Cylinder (Pack-10)	350.00
8001237	Straumann Tissue Level RN Non-Engaging Verification Cylinder	42.00
8001237-10	Straumann Tissue Level RN Non-Engaging Verification Cylinder (Pack-10)	350.00
8001236	Straumann Tissue Level RN Preparable Titanium Abutment	75.00
8001250	Straumann Tissue Level RN/WN Titanium Screw	15.00
8001250-10	Straumann Tissue Level RN/WN Titanium Screw (Pack-10)	130.00
8001251	Straumann Tissue Level RN/WN Long Guide Pin 20mm	15.00
8001261	Straumann Tissue Level RN x 4.5mm Titanium Base	50.00
8001262	Straumann Tissue Level RN x 6mm Titanium Base	50.00
8001259	Straumann Tissue Level RN Non-Engaging Titanium Base	50.00
8001240	Straumann Tissue Level RN Blue Light Scan Body	25.00
8001216	Straumann Tissue Level RN Solid Abutment Analog x 14.3 mmH (5-pack)	75.00
8001217	Straumann Tissue Level RN Solid Abutment Analog x 15.8 mmH (5-pack)	75.00
8001218	Straumann Tissue Level RN Solid Abutment Analog x 17.3 mmH (5-pack)	75.00
1600301C	Clix Complete Ball Abutment Straumann Tissue Level RN x 0mm	95.00
1600302C	Clix Complete Ball Abutment Straumann Tissue Level RN x 1mm	95.00



8001220



8001225



8001231



8001237



8001250



8001240



8001216

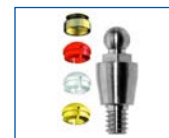

1600302C



1600303C



8001300



8001316



8001317



8001320



8001325



8001331



8001359

NUMBER	PRODUCT NAME	PRICE
1600303C	Clix Complete Ball Abutment Straumann Tissue Level RN x 2mm	95.00
1600304C	Clix Complete Ball Abutment Straumann Tissue Level RN x 3mm	95.00
1600305C	Clix Complete Ball Abutment Straumann Tissue Level RN x 4mm	95.00

SynOcta (Tissue Level) Standard WN (6.5mmD)

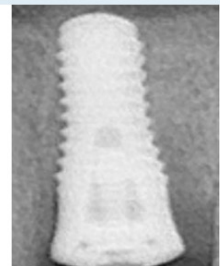
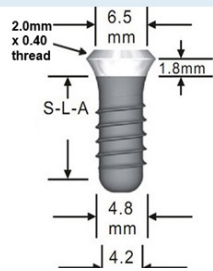

8001300	Straumann Tissue Level WN Analog	15.00
8001300-10	Straumann Tissue Level WN Analog (10-Pack)	130.00
8001300-25	Straumann Tissue Level WN Analog (25-Pack)	300.00
8001316	Straumann Tissue Level WN Solid Abutment Analog x 16.5 mmH (5-pack)	75.00
8001317	Straumann Tissue Level WN Solid Abutment Analog x 17.5 mmH (5-pack)	75.00
8001320	Straumann Tissue Level WN Engaging Gold/Plastic Abutment	225.00
8001325	Straumann Tissue Level WN Non-Engaging Gold/Plastic Abutment	225.00
8001331	Straumann Tissue Level WN Engaging Verification Cylinder	42.00
8001331-10	Straumann Tissue Level WN Engaging Verification Cylinder (10-pack)	350.00
8001337	Straumann Tissue Level WN Non-Engaging Verification Cylinder	42.00
8001337-10	Straumann Tissue Level WN Non-Engaging Verification Cylinder (10-pack)	350.00
8001359	Straumann Tissue Level WN x 4.5mm Non-Engaging Titanium Base	50.00

NUMBER	PRODUCT NAME	PRICE
8001361	Straumann Tissue Level WN x 4.5mm Titanium Base	50.00
8001362	Straumann Tissue Level WN x 6mm Titanium Base	50.00
8001340	Straumann Tissue Level WN Blue Light Scan Body	25.00

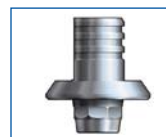

8001361



8001362



8001340



9000100



8000101



8000103



8000104



8000110



8000115

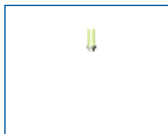

8000120

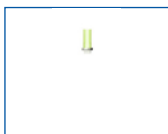

8000125

NUMBER	PRODUCT NAME	PRICE
--------	--------------	-------

SCREW VENT 3.3/3.7/4.1mm (3.5mmD)

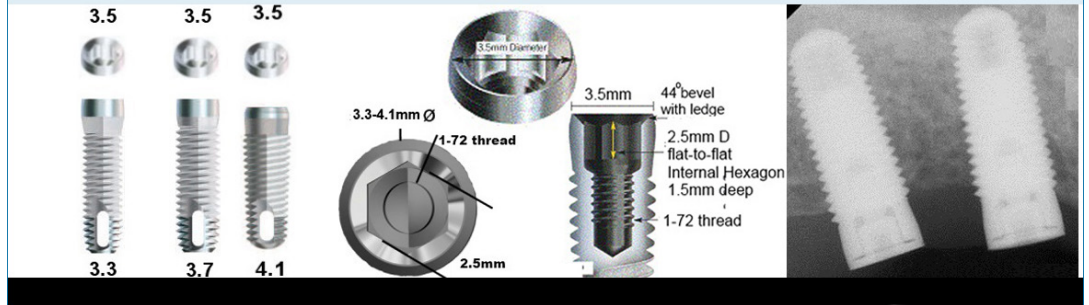

9000100	Zimmer TSV 3.5mm Analog	15.00
9000100-10	Zimmer TSV 3.5mm Analog (10-Pack)	130.00
9000100-25	Zimmer TSV 3.5mm Analog (25-Pack)	300.00
8000101	Zimmer TSV 3.5mm Open-Tray Transfer 3.5Ø x 10mm	30.00
8000102	Zimmer TSV 3.5mm Open-Tray Transfer 4.7Ø x 10mm	30.00
8000103	Zimmer TSV 3.5mm Open Tray Impression Coping Screw	15.00
8000104	Zimmer TSV 3.5mm Closed-Tray Transfer 3.5Ø x 8mm	30.00
8000105	Zimmer TSV 3.5mm Closed-Tray Transfer 4.7Ø x 8mm	30.00
8000106	Zimmer TSV 3.5mm Closed Tray Impression Coping Screw	15.00
8000110	Zimmer TSV 3.5mm Engaging Plastic UCLA	42.00
8000110-10	Zimmer TSV 3.5mm Engaging Plastic UCLA (10-pack)	350.00
8000115	Zimmer TSV 3.5mm Non-Engaging Plastic UCLA	42.00
8000115-10	Zimmer TSV 3.5mm Non-Engaging Plastic UCLA (10-pack)	350.00
8000120	Zimmer TSV 3.5mm Engaging Gold/Plastic Abutment	150.00
8000125	Zimmer TSV 3.5mm Non-Engaging Gold/Plastic Abutment	150.00

NUMBER	PRODUCT NAME	PRICE
9000130	Zimmer TSV 3.5mm Engaging Verification Cylinder	42.00
9000130-10	Zimmer TSV 3.5mm Engaging Verification Cylinder (10-Pack)	350.00
9000135	Zimmer TSV 3.5mm Non-Engaging Verification Cylinder	42.00
9000135-10	Zimmer TSV 3.5mm Non-Engaging Verification Cylinder (10-Pack)	350.00
9000150	Zimmer TSV 3.5mm/4.5mm/5.7mm Titanium Screw	15.00
9000150-10	Zimmer TSV 3.5mm/4.5mm/5.7mm Titanium Screw (10-Pack)	130.00
9000151	Zimmer TSV 3.5/4.5/5.7mm Guide Pin 20mm	15.00
8000159	Zimmer TSV 3.5mm x 4.5mm Non-Engaging Titanium Base	50.00
8000161	Zimmer TSV 3.5mm x 4.5mm Engaging Titanium Base	50.00
8000162	Zimmer TSV 3.5mm x 6mm Engaging Titanium Base	50.00
8000140	Zimmer TSV 3.5mm Blue Light Lab Scan Body	25.00
8000170	Zimmer TSV 3.5mm Esthetic Abutment 15° Angle, Anterior	105.00
8000171	Zimmer TSV 3.5mm Esthetic Abutment Straight, Anterior	105.00
8000175	Zimmer TSV 3.5mm Straight Multi-Unit Abutment x 1mm	125.00
8000176	Zimmer TSV 3.5mm Straight Multi-Unit Abutment x 2mm	125.00
8000180	Zimmer TSV 3.5mm 17° Multi-Unit Abutment x 2mm	125.00
8000181	Zimmer TSV 3.5mm 17° Multi-Unit Abutment x 3mm	125.00
8000185	Zimmer TSV 3.5mm 30° Multi-Unit Abutment x 3mm	125.00
1600100C	Clix Complete Ball Abutment Zimmer TSV 3.5mm x 1mm	95.00
1600102C	Clix Complete Ball Abutment Zimmer TSV 3.5mm x 2mm	95.00



9000130



9000135



9000150



9000151



8000159



8000161



8000162



8000140



8000170



1600103C



1600104C



1600106C



1600802C



1600804C



1600805C



9000200



8000201

TSV 3.5mm NP

180

TSV 4.5mm RP

NUMBER	PRODUCT NAME	PRICE
1600103C	Clix Complete Ball Abutment Zimmer TSV 3.5mm x 3mm	95.00
1600104C	Clix Complete Ball Abutment Zimmer TSV 3.5mm x 4mm	95.00
1600105C	Clix Complete Ball Abutment Zimmer TSV 3.5mm x 5mm	95.00
1600106C	Clix Complete Ball Abutment Zimmer TSV 3.5mm x 6mm	95.00
1600801C	O-Ring Complete Ball Abutment Zimmer TSV 3.5mm x 1mm	75.00
1600802C	O-Ring Complete Ball Abutment Zimmer TSV 3.5mm x 2mm	75.00
1600803C	O-Ring Complete Ball Abutment Zimmer TSV 3.5mm x 3mm	75.00
1600804C	O-Ring Complete Ball Abutment Zimmer TSV 3.5mm x 4mm	75.00
1600805C	O-Ring Complete Ball Abutment Zimmer TSV 3.5mm x 5mm	75.00
1600806C	O-Ring Complete Ball Abutment Zimmer TSV 3.5mm x 6mm	75.00

SCREW VENT 4.7mm DIAMETER (4.5mmD)

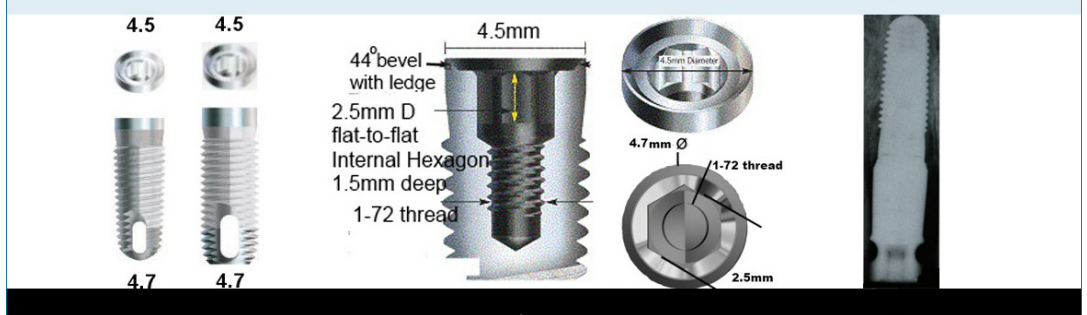

9000200	Zimmer TSV 4.5mm Analog	15.00
9000200-10	Zimmer TSV 4.5mm Analog (10-Pack)	130.00
9000200-25	Zimmer TSV 4.5mm Analog (25-Pack)	300.00
8000201	Zimmer TSV 4.5mm Open-Tray Transfer 3.5Ø x 10mm	30.00
8000202	Zimmer TSV 4.5mm Open-Tray Transfer 4.7Ø x 10mm	30.00

NUMBER	PRODUCT NAME	PRICE
8000204	Zimmer TSV 4.5mm Closed-Tray Transfer 4.5Ø x 8mm	30.00
8000205	Zimmer TSV 4.5mm Closed-Tray Transfer 5.7Ø x 8mm	30.00
8000210	Zimmer TSV 4.5mm Engaging Plastic UCLA	42.00
8000210-10	Zimmer TSV 4.5mm Engaging Plastic UCLA (10-Pack)	350.00
8000215	Zimmer TSV 4.5mm Non-Engaging Plastic UCLA	42.00
8000215-10	Zimmer TSV 4.5mm Non-Engaging Plastic UCLA (10-Pack)	350.00
8000220	Zimmer TSV 4.5mm Engaging Gold/Plastic Abutment	155.00
8000225	Zimmer TSV 4.5mm Non-Engaging Gold/Plastic Abutment	155.00
9000230	Zimmer TSV 4.5mm Engaging Verification Cylinder	42.00
9000230-10	Zimmer TSV 4.5mm Engaging Verification Cylinder (10-Pack)	350.00
9000235	Zimmer TSV 4.5mm Non-Engaging Verification Cylinder	42.00
9000235-10	Zimmer TSV 4.5mm Non-Engaging Verification Cylinder (10-Pack)	350.00
9000150	Zimmer TSV 3.5mm/4.5mm/5.7mm Titanium Screw	15.00
9000150-10	Zimmer TSV 3.5mm/4.5mm/5.7mm Titanium Screw (10-Pack)	130.00
9000151	Zimmer TSV 3.5/4.5/5.7mm Guide Pin 20mm	15.00
8000259	Zimmer TSV Non-Engaging 4.5mm x 4.5mm Titanium Base	50.00
8000261	Zimmer TSV 4.5mm x 4.5mm Engaging Titanium Base	50.00
8000262	Zimmer TSV 4.5mm x 6mm Engaging Titanium Base	50.00
8000240	Zimmer TSV 4.5mm Blue Light Lab Scan Body	25.00
8000270	Zimmer TSV 4.5mm Esthetic Abutment 15° Angle, Anterior	105.00



8000204



8000210



8000215



8000220



9000230



9000235



8000261



8000240



8000271



8000272



8000275



8000280



8000286

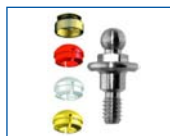

1600200C



1600206C

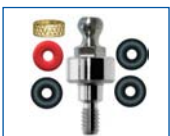

1600812C

NUMBER	PRODUCT NAME	PRICE
8000271	Zimmer TSV 4.5mm Esthetic Abutment Straight, Anterior	105.00
8000272	Zimmer TSV 4.5mm Esthetic Abutment 15° Angle, Posterior	105.00
8000273	Zimmer TSV 4.5mm Esthetic Abutment Straight, Posterior	105.00
8000275	Zimmer TSV 4.5mm Straight Multi-Unit Abutment x 1mm	125.00
8000276	Zimmer TSV 4.5mm Straight Multi-Unit Abutment x 2mm	125.00
8000277	Zimmer TSV 4.5mm Straight Multi-Unit Abutment x 3mm	125.00
8000278	Zimmer TSV 4.5mm Straight Multi-Unit Abutment x 5mm	125.00
8000280	Zimmer TSV 4.5mm 17° Multi-Unit Abutment x 2mm	125.00
8000281	Zimmer TSV 4.5mm 17° Multi-Unit Abutment x 3mm	125.00
8000283	Zimmer TSV 4.5mm 17° Multi-Unit Abutment x 5mm	125.00
8000285	Zimmer TSV 4.5mm 30° Multi-Unit Abutment x 3mm	125.00
8000286	Zimmer TSV 4.5mm 30° Multi-Unit Abutment x 5mm	125.00
1600200C	Clix Complete Ball Abutment Zimmer TSV 4.5mm x 0.5mm	95.00
1600202C	Clix Complete Ball Abutment Zimmer TSV 4.5mm x 2mm	95.00
1600203C	Clix Complete Ball Abutment Zimmer TSV 4.5mm x 3mm	95.00
1600204C	Clix Complete Ball Abutment Zimmer TSV 4.5mm x 4mm	95.00
1600205C	Clix Complete Ball Abutment Zimmer TSV 4.5mm x 5mm	95.00
1600206C	Clix Complete Ball Abutment Zimmer TSV 4.5mm x 6mm	95.00
1600811C	O-Ring Complete Ball Abutment Zimmer TSV 4.5mm x 1mm	75.00
1600812C	O-Ring Complete Ball Abutment Zimmer TSV 4.5mm x 2mm	75.00

NUMBER	PRODUCT NAME	PRICE
1600813C	O-Ring Complete Ball Abutment Zimmer TSV 4.5mm x 3mm	75.00
1600814C	O-Ring Complete Ball Abutment Zimmer TSV 4.5mm x 4mm	75.00
1600815C	O-Ring Complete Ball Abutment Zimmer TSV 4.5mm x 5mm	75.00
1600816C	O-Ring Complete Ball Abutment Zimmer TSV 4.5mm x 6mm	75.00



1600813C



1600816C

Screw Vent / Tapered Screw Vent 5.7mmD

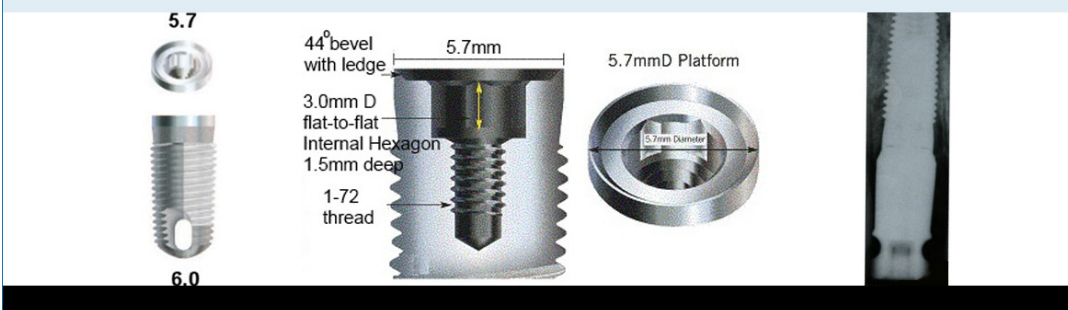

9000300



8000301



8000310



8000315



8000320



8000325

9000300	Zimmer TSV 5.7mm Analog	15.00
9000300-10	Zimmer TSV 5.7mm Analog (10-Pack)	130.00
9000300-25	Zimmer TSV 5.7mm Analog (25-Pack)	300.00
8000301	Zimmer TSV 5.7mm Open Tray Impression Coping	30.00
8000304	Zimmer TSV 5.7mm Closed Tray Impression Coping	30.00
8000310	Zimmer TSV 5.7mm Engaging Plastic UCLA	42.00
8000310-10	Zimmer TSV 5.7mm Engaging Plastic UCLA (10-Pack)	350.00
8000315	Zimmer TSV 5.7mm Non-Engaging Plastic UCLA	42.00
8000315-10	Zimmer TSV 5.7mm Non-Engaging Plastic UCLA (10-Pack)	350.00
8000320	Zimmer TSV 5.7mm Engaging Gold/Plastic Abutment	175.00
8000325	Zimmer TSV 5.7mm Non-Engaging Gold/Plastic Abutment	175.00



9000330



9000335



9000150



9000151



8000359



8000361



8000362



8000340

NUMBER	PRODUCT NAME	PRICE
9000330	Zimmer TSV 5.7mm Engaging Verification Cylinder	42.00
9000330-10	Zimmer TSV 5.7mm Engaging Verification Cylinder (10-Pack)	350.00
9000335	Zimmer TSV 5.7mm Non-Engaging Verification Cylinder	42.00
9000335-10	Zimmer TSV 5.7mm Non-Engaging Verification Cylinder (10-Pack)	350.00
9000150	Zimmer TSV 3.5mm/4.5mm/5.7mm Titanium Screw	15.00
9000150-10	Zimmer TSV 3.5mm/4.5mm/5.7mm Titanium Screw (10-Pack)	130.00
9000151	Zimmer TSV 3.5/4.5/5.7mm Guide Pin 20mm	15.00
8000359	Zimmer TSV Non-Engaging 5.7mm x 4.5mm Titanium Base	50.00
8000361	Zimmer TSV 5.7mm x 4.5mm Engaging Titanium Base	50.00
8000362	Zimmer TSV 5.7mm x 6mm Engaging Titanium Base	50.00
8000340	Zimmer TSV 5.7mm Blue Light Lab Scan Body	25.00

Implant Buddy

SERVICE 99% OF IMPLANT CASES WITH ONE HANDY SET

#9000000

NEW

The Omega Torque Wrench



• Works hand in hand with the Implant Buddy

• High Precision Calibrated Torque

• Adjust from 10 to 70 Ncm!!

9000020

EASY STERILIZATION

EITHER THE INDIVIDUAL DRIVER(S) OR THE ENTIRE BUDDY!

TAPERED BITS

FOR A STRONGER CONNECTION

SHORT & LONG BITS

FOR EACH PROSTHETIC SCREW CONNECTION

SHORT & LONG DRIVER

MAGNETIC BASE

ALL COMPONENTS STAY IN PLACE AND ON THE SURGICAL TRAY

SMART THUMB KNOB

GOES DIRECTLY INTO TORQUE DRIVER

COLOR CODED BITS

FOR EASY VISIBILITY

SMALL SIZE

PROVIDES MORE WORKING SPACE

SERVICEABLE DESIGN

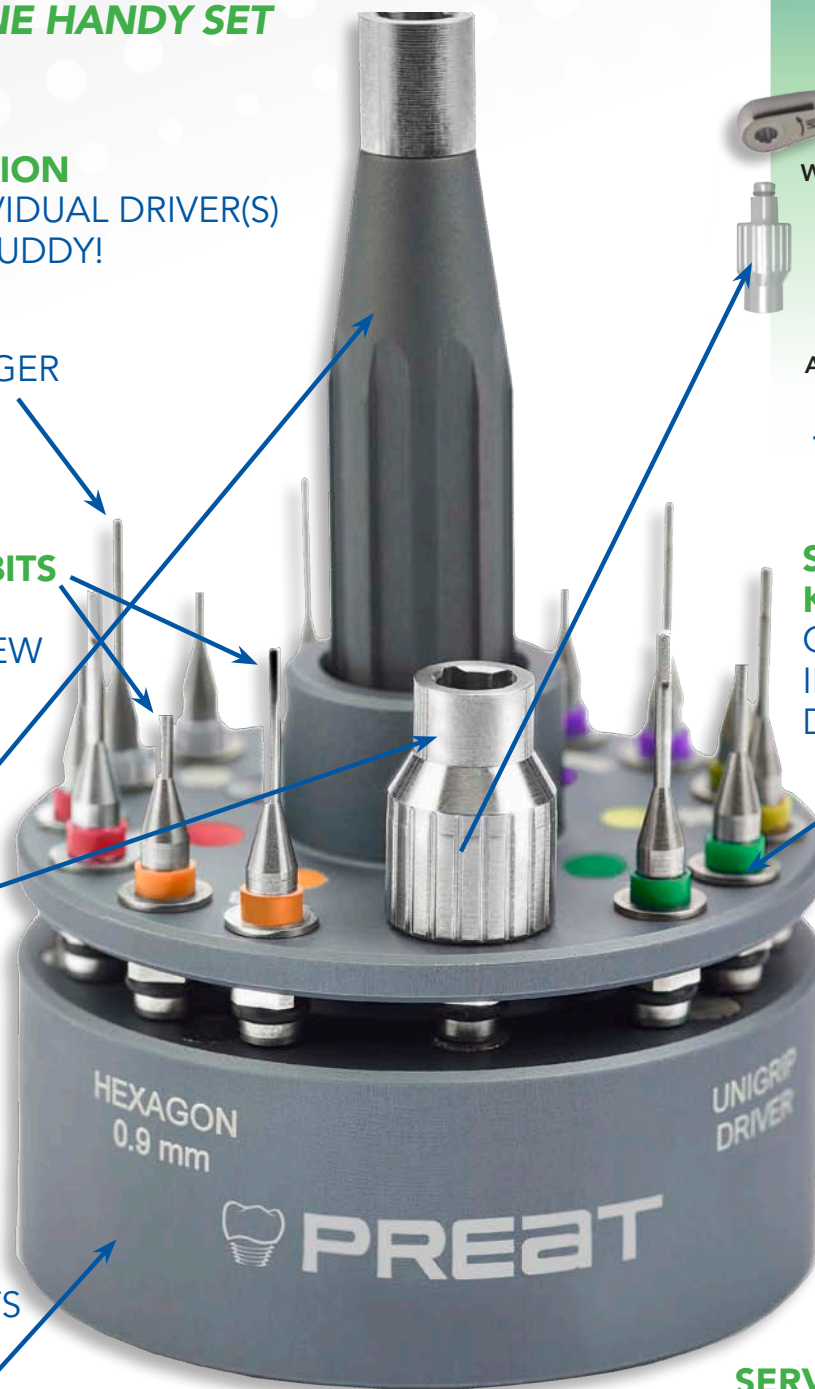

Prosthetic Connections Included:

Straight, SCS, UniGrip, Hex 1.3mm/.050 inch, Hex 1.2mm/.048 inch, Hex 0.9mm/.035 inch, and Square 1.3mm/.050 inch

PREAT.com

 **PREAT**

1-800-232-7732

IMPLANT COMPONENTS AND DRIVERS



9000000



9000020



8000000



8000010



8000020



8000085



8000085



9000038

DRIVER / PROSTHETIC CONNECTION		SYSTEMS
	Straight Driver	Straight Systems
	SCS Driver	Straumann
	UniGrip Driver	Nobel BioCare
	Hex 1.3mm/.050 inch	Lifecore, BioHorizon, Astra, Zimmer
	Hex 1.2mm/.048 inch	3i System
	Hex 0.9mm/.035 inch	Friadent, Ankylos 3i Cover Screw
	Angled Driver	Dynamic Systems
	Square 1.3mm/.050 inch	Gold Screw/Nobel Biocare

NUMBER	PRODUCT NAME	PRICE
9000000	Implant Buddy Driver Set	550.00
9000020	Omega Adjustable Torque Wrench: Works hand in hand with the Implant Buddy. This High Precision Calibrated Torque can adjust from 10 to 70 Ncm!	400.00
8000000	Long Handle Universal Implant Driver Set • 4.25 inches long, includes Straight, SCS, Unigrip, .050, .048, .035, and .050 Square	350.00
8000010	Short Handle Universal Driver Set • 1.75 inches long, includes Straight, SCS, Unigrip, .050, .048, .035, and .050 Square	350.00
8000020	Right-Angled Driver (No Torque) • Manually driven, adjustable angle driver	425.00
8000019	Adjustable Torque Adapter for Right-Angled Driver • Snaps into Right-Angled Driver and can be set at values ranging from 10-35 Ncm	500.00
4009020	30N-cm Torque and Thumb Knob Wrench Kit	229.00
4034391	20N-cm LOCATOR Torque and Thumb Knob Wrench Kit	229.00
1600035	Latch to Square Driver Insert	40.00
1600036	Square To Straumann Driver Insert	60.00
8000085	Cuff Height & Angulation Tool Set	99.00
8000080	Cuff Height Measuring Tool	110.00

IMPLANT COMPONENTS AND DRIVERS

NUMBER	PRODUCT NAME	PRICE
9000041	PAC Hand Driver	40.00
9000043	Dynamic Square Type Angled Driver (15mm)	80.00
9000044	Dynamic Square Type Angled Driver (30mm)	80.00

LATCH TYPE DRIVERS

8000030	Latch-Type Driver Set of 7: Straight, SCS, Unigrip, .050, .048, .035, and .050 Square in an autoclaveable holder	350.00
8000031	Latch-Type Straight Driver	85.00
8000036	Latch-Type .035 Hex Driver	85.00
8000032	Latch-Type SCS Driver	85.00
8000033	Latch-Type UniGrip Driver	85.00
8000034	Latch-Type .050 Hex Driver	85.00
8000035	Latch-Type .048 Hex Driver	85.00
8000037	Latch-Type .050 Square Driver	85.00

SQUARE TYPE DRIVERS

8000050	Square Type Drivers Set of 7 - Short: Straight, SCS, Unigrip, .050, .048, .035, and .050 Square in an autoclaveable holder	350.00
8000060	Square Type Drivers Set of 7 - Medium: Straight, SCS, Unigrip, .050, .048, .035, and .050 Square in an autoclaveable holder	350.00
8000070	Square Type Drivers Set of 7 - Long: Straight, SCS, Unigrip, .050, .048, .035, and .050 Square in an autoclaveable holder	350.00

Square Type Prosthetic Connection	Short Total Length 18mm Shaft Length 11mm	Medium Total Length 23mm Shaft Length 16mm	Long Total Length 39mm Shaft Length 32mm
Straight Driver	8000051	8000061	8000071
SCS Driver	8000052	8000062	8000072
UniGrip Driver	8000053	8000063	8000073
.050 Hex Driver	8000054	8000064	8000074
.048 Hex Driver	8000055	8000065	8000075
.035 Hex Driver	8000056	8000066	8000076
.050 Square Driver	8000057	8000067	8000077



Straight



SCS



UniGrip



.050 Hex



.048 Hex



.035 Hex



.050 Square



8000050

All Square Type Driver Bits priced individually at \$85.00



Tired of Guessing Abutment Heights and Angulations?



Abutments too high?



Abutments too low?



Wrong Angulation?

Now there is a SOLUTION!

The Must Have Tool for
All Implant Professionals

#8000085 \$99

The Cuff Height
and Angulation Set*

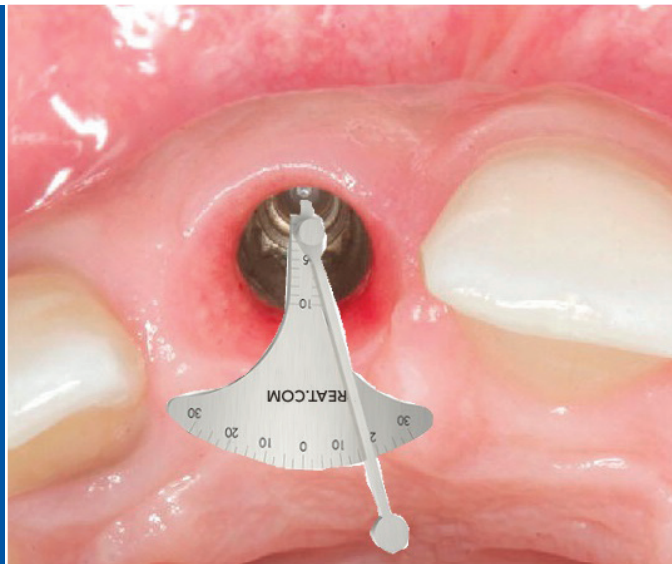

Ideal for esthetic
abutments,
multi-unit abutments, and
all removable abutments.

||

*This is a must have tool for anyone doing anything
implant related. I use this tool daily!*

– SEVAN PULURIAN, PACIFIC DENTAL

*This tool really saves me time and confusion on large
implant cases. It takes away all the guesswork and
permits me to plant these cases accurately from the
laboratory, allowing for the proper
ordering of necessary components.*

– JOSHUA POLANSKY, MDC, NICHE DENTAL STUDIO

*When things get tough small tools can have a big impact.
Using this one almost every day.*

Thank you PREAT, great development!

– ALEXANDER WINSCHKE, CDT, ZAHNTECHNIQUE INC.

*It is newer and better than the angulation
ruler I have been using.*

– ELIZABETH CURRAN, CDT, RDT

||

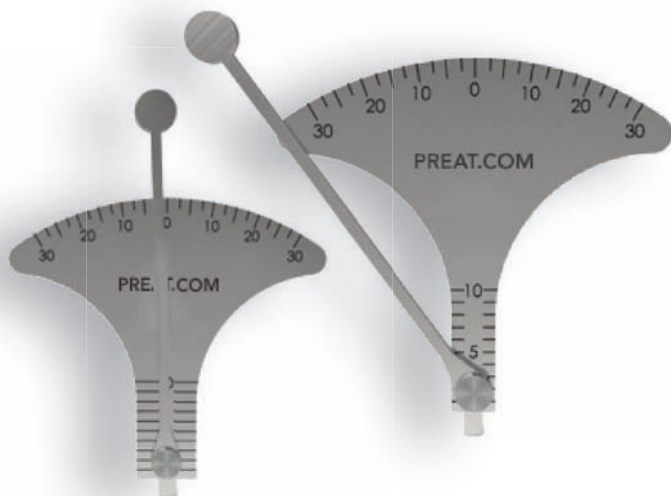

easy to use....

1. Place the tool on top of the implant platform to measure gingival height.
2. Rotate angle measurement arm to identify if a straight abutment, 17° or 30° degree abutment is necessary.

*Set includes two diameters of the tool, allowing use on implants from 3mm to 6mm \varnothing .

PREAT.com

 PREAT™

1-800-232-7732

Compatibility Chart

SYSTEM	COMPATIBLE WITH:	PAGE
3i Osseotite XP 3.75 & 4.1mm Standard	Nobel Branemark RP 3.75 / 4.1mm	161
AB Dental 3.75mm NP	Zimmer Screw-Vent / Tapered Screw-Vent 3.3 / 3.7 / 4.1mm (3.5mm Ø)	180
AB Dental 4.50mm WP	Zimmer Screw-Vent / Tapered Screw-Vent 4.7mm Diameter (4.5mm Ø)	182
ACE Infinity Internal Hex 3.7 / 4.1mm	Zimmer Screw-Vent / Tapered Screw-Vent 3.3 / 3.7 / 4.1mm (3.5mm Ø)	180
ACE Infinity Internal Hex 4.7 / 5.1mm	Zimmer Screw-Vent / Tapered Screw-Vent 4.7mm Diameter (4.5mm Ø)	182
ACE Infinity TRI-CAM 3.5mm	Nobel Replace Tri-Lobe NP 3.5mm	163
ACE Infinity TRI-CAM 4.3mm	Nobel Replace Tri-Lobe RP 4.3mm	165
ACE Infinity TRI-CAM 5.0mm	Nobel Replace Tri-Lobe WP 5.0mm	168
ACE Infinity X-hex Implant 3.3mm	Nobel Branemark NP 3.3mm	
ACE Infinity X-hex Implant 3.7 / 4.0mm	Nobel Branemark RP 3.75 / 4.1mm	161
ACE Infinity X-hex Implant 4.75mm	Nobel Branemark WP 5.0mm	163
Adin Touareg	Zimmer Screw-Vent / Tapered Screw-Vent 3.3 / 3.7 / 4.1mm (3.5mm Ø)	180
Alfa Gate Bioactive	Zimmer Screw-Vent / Tapered Screw-Vent 3.3 / 3.7 / 4.1mm (3.5mm Ø)	180
Alfa Gate DFCl 3.5mm	Zimmer Screw-Vent / Tapered Screw-Vent 3.3 / 3.7 / 4.1mm (3.5mm Ø)	180
Almitech Implant System	Straumann SynOcta (Tissue Level) Standard RN (4.8mmD)	176
Alpha Bio ICE / SPI 3.5	Zimmer Screw-Vent / Tapered Screw-Vent 3.3 / 3.7 / 4.1mm (3.5mm Ø)	180
Alpha Dent Active / Plus	Zimmer Screw-Vent / Tapered Screw-Vent 3.3 / 3.7 / 4.1mm (3.5mm Ø)	180
Alpha Dent Bio	Zimmer Screw-Vent / Tapered Screw-Vent 3.3 / 3.7 / 4.1mm (3.5mm Ø)	180
Alpha Dent Classic	Zimmer Screw-Vent / Tapered Screw-Vent 3.3 / 3.7 / 4.1mm (3.5mm Ø)	180
Alpha Dent Conus	Zimmer Screw-Vent / Tapered Screw-Vent 3.3 / 3.7 / 4.1mm (3.5mm Ø)	180
American Dental Implant Internal Hex Skinny 2.4 (3.5)	Zimmer Screw-Vent / Tapered Screw-Vent 3.3 / 3.7 / 4.1mm (3.5mm Ø)	180
American Dental Implant Internal Hex Small (3.5)	Zimmer Screw-Vent / Tapered Screw-Vent 3.3 / 3.7 / 4.1mm (3.5mm Ø)	180
American Dental Implant Internal Hex Wide (4.5)	Zimmer Screw-Vent / Tapered Screw-Vent 4.7mm Diameter (4.5mm Ø)	182
American Dental Implant Internal Hex XL (5.7)	Zimmer Screw-Vent / Tapered Screw-Vent 5.7mm	185
ARDS Classic 3.75mm	Zimmer Screw-Vent / Tapered Screw-Vent 3.3 / 3.7 / 4.1mm (3.5mm Ø)	180
AS Technology c-fix Cone Morse Regular (4.8)	Straumann SynOcta (Tissue Level) Standard RN (4.8mmD)	176
AS Technology e-fix Ext Hexagon-Narrow Platform (3.5)	Straumann SynOcta (Tissue Level) Standard NN (3.5mmD)	176
AS Technology e-fix Ext Hexagon-Regular Platform (4.1)	Nobel Branemark RP 3.75 / 4.1mm	161
AS Technology e-fix Turque Interno-Regular Platform (4.1)	Nobel Branemark RP 3.75 / 4.1mm	161
Avinent Externa	Nobel Branemark RP 3.75 / 4.1mm	161
B&W External Hexagonal (4.1)	Nobel Branemark RP 3.75 / 4.1mm	161
B&W External Hexagonal (5.0)	Biomet 3i Osseotite XP 5.0mm WP	
B&W External Hexagonal Cylindrical (3.3)	Steri-Oss Hex Lock 3.25mm	
B&W Tapered Morse MEI (4.8)	Straumann SynOcta (Tissue Level) Standard RN (4.8mmD)	176
BioHorizon Internal 3.5	Zimmer Screw-Vent / Tapered Screw-Vent 3.3 / 3.7 / 4.1mm (3.5mm Ø)	180
BioHorizon Internal 4.5	Zimmer Screw-Vent / Tapered Screw-Vent 4.7mm Diameter (4.5mm Ø)	182

Compatibility Chart

SYSTEM	COMPATIBLE WITH:	PAGE
BioHorizon Internal 5.7	Zimmer Screw-Vent / Tapered Screw-Vent 5.7mm	185
BIO-LOK 4.0mm IC (Silhouette)	Nobel Branemark RP 3.75 / 4.1mm	161
BIO-LOK External Hex	Nobel Branemark RP 3.75 / 4.1mm	161
Biomain Combine Narrow 3.5	Nobel Replace Tri-Lobe NP 3.5mm	163
Biomain Combine Regular 4.3	Nobel Replace Tri-Lobe RP 4.3mm	165
Biomain Combine Wide 5.0	Nobel Replace Tri-Lobe WP 5.0mm	168
Biomain External Hexagon Narrow (3.5)	Nobel Branemark NP 3.3mm	
Biomain External Hexagon Regular (4.1)	Nobel Branemark RP 3.75 / 4.1mm	161
Biomain External Hexagon Wide (5.1)	Nobel Branemark WP 5.0mm	163
Biomain I-Fix Regular (4.8)	Straumann SynOcta (Tissue Level) Standard RN (4.8mmD)	176
Bionnovation Hexagono Ext HE Classic Cilindrico SP (3.3)	Steri-Oss Hex Lock 3.25mm	
Bionnovation Hexagono Externo HE Classic WP (5.0)	Intra-Lock Threaded Conic 4.75/ 5.0mm Ex Hex	
Bionnovation Hexagono Externo HE RP (4.1)	Nobel Branemark RP 3.75 / 4.1mm	161
Biotech Korum External (3.3) / TOP (3.4) / TRE (3.4)	Biomet 3i 3.25mm & 3.3mm MicroMiniplant	
Biotech Korum External / TOP / TRE (4.0)	Nobel Branemark RP 3.75 / 4.1mm	161
Biotech Korum External / TOP / TRE (5.0)	Biomet 3i Osseotite XP 5.0mm WP	
Blue Sky Bio Conus 12 3.5/4.0	Astra Tech Osseospeed 3.5/4.0s (AQUA)	132
Blue Sky Bio Conus 12 4.5/5.0	Astra Tech Osseospeed 4.5/5.0s (LILAC)	134
Blue Sky Bio Internal Hex 3.5mm Green	Zimmer Screw-Vent / Tapered Screw-Vent 3.3 / 3.7 / 4.1mm (3.5mm Ø)	180
Blue Sky Bio Internal Hex 4.5mm Purple	Zimmer Screw-Vent / Tapered Screw-Vent 4.7mm Diameter (4.5mm Ø)	182
Blue Sky Bio One Stage RN (4.1mm)	Straumann SynOcta (Tissue Level) Standard RN (4.8mmD)	176
Blue Sky Bio Three	Astra Tech Osseospeed 3.0s	131
Blue Sky Bio Tri-Lobe 6.0mm	Nobel Replace Tri-Lobe 6.0mm	170
Blue Sky Bio Tri-Lobe NP	Nobel Replace Tri-Lobe NP 3.5mm	163
Blue Sky Bio Tri-Lobe RP	Nobel Replace Tri-Lobe RP 4.3mm	165
Blue Sky Bio Tri-Lobe WP	Nobel Replace Tri-Lobe WP 5.0mm	168
Blue Sky MAX	Nobel Active / Conical Connection NP 3.5mm	155
Branemark Compatible	Biomet 3i Osseotite XP 3.75 & 4.1mm Standard	
BTI Externa and Externa Plus RP	Nobel Branemark RP 3.75 / 4.1mm	161
Calcitek Threadlock 4.0mm	Nobel Branemark RP 3.75 / 4.1mm	161
Cowell Atlas Internal	Straumann SynOcta (Tissue Level) Standard RN (4.8mmD)	176
Dentis Classic, Prestige, Rapid	Zimmer Screw-Vent / Tapered Screw-Vent 3.3 / 3.7 / 4.1mm (3.5mm Ø)	180
Dentium	Hiossen GS II Standard 4.0 / 4.5 / 5.0mm	146
DSI Internal Implant System	Straumann SynOcta (Tissue Level) Standard RN (4.8mmD)	176
Glidewell Laboratories Inclusive 3.5mm	Zimmer Screw-Vent / Tapered Screw-Vent 3.3 / 3.7 / 4.1mm (3.5mm Ø)	180
Glidewell Laboratories Inclusive 4.5mm	Zimmer Screw-Vent / Tapered Screw-Vent 4.7mm Diameter (4.5mm Ø)	182

Compatibility Chart

SYSTEM	COMPATIBLE WITH:	PAGE
Hahn Tapered 3.0mm	Nobel Active / Conical Connection 3.0mm	154
Hahn Tapered 3.5, 4.3mm	Nobel Active / Conical Connection NP 3.5mm	155
Hahn Tapered 5.0mm	Nobel Active / Conical Connection RP 4.3/5.0mm	157
Hahn Tapered 7.0mm	Nobel Active / Conical Connection WP 5.0mm	160
Hiossen GS III Standard 4.0 / 4.5 / 5.0mm	Hiossen GS II Standard 4.0 / 4.5 / 5.0mm	146
Hiossen GS Ultra Wide 6.0 / 7.0mm	Hiossen GS II Standard 4.0 / 4.5 / 5.0mm	146
Hiossen SS I / II / III Regular 4.8mm	Straumann SynOcta (Tissue Level) Standard RN (4.8mmD)	176
Hiossen SS III Wide 6.0mm	Hiossen SS II Wide 6.0mm	
Hiossen SS Ultra Wide 6.0mm	Hiossen SS II Wide 6.0mm	
Hiossen US II / III Plus Regular 4.1mm	Nobel Branemark RP 3.75 / 4.1mm	161
Hiossen US II / III Plus Wide 5.1mm	Nobel Branemark WP 5.0mm	163
Hiossen US II / III Regular 4.1mm	Nobel Branemark RP 3.75 / 4.1mm	161
Hiossen US II / III Wide 5.1mm	Nobel Branemark WP 5.0mm	163
Hiossen US II Mini 3.5mm	Nobel Branemark NP 3.3mm	
Hiossen US II Plus Mini 3.5mm	Nobel Branemark NP 3.3mm	
Hiossen US Mini 3.5mm	Nobel Branemark NP 3.3mm	
Hiossen US Ultra Wide 5.1mm	Nobel Branemark WP 5.0mm	163
Hi-Tec Implex / Summitt 4.1mm	Nobel Branemark RP 3.75 / 4.1mm	161
Hi-Tec Logic 3.5mm	Nobel Active / Conical Connection NP 3.5mm	155
Hi-Tec Logic 4.3 / 5.0mm	Nobel Active / Conical Connection RP 4.3/5.0mm	157
Hi-Tec Smooth & Slim Fit	Zimmer Screw-Vent / Tapered Screw-Vent 3.3 / 3.7 / 4.1mm (3.5mm Ø)	180
Hi-Tec Tapered Self Thread 3.5mm	Zimmer Screw-Vent / Tapered Screw-Vent 3.3 / 3.7 / 4.1mm (3.5mm Ø)	180
Hi-Tec Tapered Self Thread 4.5mm	Zimmer Screw-Vent / Tapered Screw-Vent 4.7mm Diameter (4.5mm Ø)	182
Hi-Tec Tapered Tite Fit 4.8	Straumann SynOcta (Tissue Level) Standard RN (4.8mmD)	176
Hi-Tec Vision 3.5mm	Nobel Replace Tri-Lobe NP 3.5mm	163
Hi-Tec Vision 4.3mm	Nobel Replace Tri-Lobe RP 4.3mm	165
Hi-Tec Vision 5.0mm	Nobel Replace Tri-Lobe WP 5.0mm	168
IDS Reflect Aspire 3.5/4.0mm	Astra Tech Osseospeed 3.5/4.0s (AQUA)	132
IDS Reflect Aspire 4.5/5.0mm	Astra Tech Osseospeed 4.5/5.0s (LILAC)	134
IDS Reflect Rapid 3.5mm	Nobel Active / Conical Connection NP 3.5mm	155
IDS Reflect Rapid 4.3mm	Nobel Active / Conical Connection RP 4.3/5.0mm	157
IDS Reflect Rapid 5.0mm	Nobel Active / Conical Connection WP 5.0mm	160
IDS Reflect Recover 3.5mm	Nobel Replace Tri-Lobe NP 3.5mm	163
IDS Reflect Recover 4.3mm	Nobel Replace Tri-Lobe RP 4.3mm	165
IDS Reflect Recover 5.0mm	Nobel Replace Tri-Lobe WP 5.0mm	168
IDS Reflect Tapered 3.7-4.1	Zimmer Screw-Vent / Tapered Screw-Vent 3.3 / 3.7 / 4.1mm (3.5mm Ø)	180

Compatibility Chart

SYSTEM	COMPATIBLE WITH:	PAGE
IDS Reflect Tapered 4.7	Zimmer Screw-Vent / Tapered Screw-Vent 4.7mm Diameter (4.5mm Ø)	182
Implant Direct InterActive NP	Nobel Active / Conical Connection NP 3.5mm	155
Implant Direct InterActive RP	Nobel Active / Conical Connection RP 4.3/5.0mm	157
Implant Direct Legacy 1/2/3/4 3.5mmD	Zimmer Screw-Vent / Tapered Screw-Vent 3.3 / 3.7 / 4.1mm (3.5mm Ø)	180
Implant Direct Legacy 1/2/3/4 4.5mmD	Zimmer Screw-Vent / Tapered Screw-Vent 4.7mm Diameter (4.5mm Ø)	182
Implant Direct Legacy 1/2/3/4 5.7mmD	Zimmer Screw-Vent / Tapered Screw-Vent 5.7mm	185
Implant Direct RePlant / RePlus / ReActive NP	Nobel Replace Tri-Lobe NP 3.5mm	163
Implant Direct RePlant / RePlus / ReActive RP	Nobel Replace Tri-Lobe RP 4.3mm	165
Implant Direct RePlant / RePlus / ReActive WP	Nobel Replace Tri-Lobe WP 5.0mm	168
Implant Direct SwishPlant / SwishPlus (4.8mmD)	Straumann SynOcta (Tissue Level) Standard RN (4.8mmD)	176
Imtec 3.40/ 3.75/ 4.0mm external hex	Nobel Branemark RP 3.75 / 4.1mm	161
IMZ 3.3 / 4.0mm External Hex	Nobel Branemark RP 3.75 / 4.1mm	161
Innova Endopore 4.1 / 5.0mm (One-Stage)	Straumann SynOcta (Tissue Level) Standard RN (4.8mmD)	176
Innova Endopore 4.1mm	Nobel Branemark RP 3.75 / 4.1mm	161
Innova Endopore 5.0mm / Entegra 4.7mm (0.7mm) Ext Hex	Biomet 3i Osseotite XP 5.0mm WP	
Innova Entegra 3.25 - 4.1mm (0.7mm) External Hex	Nobel Branemark RP 3.75 / 4.1mm	161
Innova Hex Plus 4.1mm	Nobel Branemark RP 3.75 / 4.1mm	161
Innova Pro Series (TL) Tissue Level 4.1 / 4.8mm	Straumann SynOcta (Tissue Level) Standard RN (4.8mmD)	176
Innova Pro Series XRT Bone Level 4.8mm	Straumann SynOcta (Tissue Level) Standard RN (4.8mmD)	176
Intra-Lock 3.75 / 4.0mm External Hex	Nobel Branemark RP 3.75 / 4.1mm	161
Intra-Lock 4.3mm Standard Platform Conic Body	Straumann SynOcta (Tissue Level) Standard RN (4.8mmD)	176
Lifecore Stage One 3.3 / 4.1 / 4.8mm (RDS)	Straumann SynOcta (Tissue Level) Standard RN (4.8mmD)	176
Luna RP 2.5mm	Hiossen GS II Standard 4.0 / 4.5 / 5.0mm	146
MegaGen ExFeel External Hex	Nobel Branemark RP 3.75 / 4.1mm	161
MegaGen ExFeel External Hex Small (3.5)	Nobel Branemark NP 3.3mm	
MegaGen ExFeel External Hex Wide (5.0)	Biomet 3i Osseotite XP 5.0mm WP	
MegaGen ExFeel Internal Straight/Taper (4.8)	Straumann SynOcta (Tissue Level) Standard RN (4.8mmD)	176
MIS C4 3.75 / 4.20mm	Zimmer Screw-Vent / Tapered Screw-Vent 3.3 / 3.7 / 4.1mm (3.5mm Ø)	180
MIS Lance External hex Standard Platform 4.1mm	Nobel Branemark RP 3.75 / 4.1mm	161
MIS Lance External hex Wide Platform (5.0)	Biomet 3i Osseotite XP 5.0mm WP	
MIS Mistral Internal Morse Taper One Stage RN	Straumann SynOcta (Tissue Level) Standard RN (4.8mmD)	176
MIS Seven 3.75 / 4.20mm	Zimmer Screw-Vent / Tapered Screw-Vent 3.3 / 3.7 / 4.1mm (3.5mm Ø)	180
MIS Seven 4.5	Zimmer Screw-Vent / Tapered Screw-Vent 4.7mm Diameter (4.5mm Ø)	182
Neodent Titamax TI Medular (4.1)	Nobel Branemark RP 3.75 / 4.1mm	161
Neodent Titamax TI Medular (5.0)	Intra-Lock Threaded Conic 4.75/ 5.0mm Ex Hex	
OSTEO Implant System External Hex	Nobel Branemark RP 3.75 / 4.1mm	161

Compatibility Chart

SYSTEM	COMPATIBLE WITH:	PAGE
Paragon Bio-Vent 3.5mm Diameter (3.5mm D)	Zimmer Screw-Vent / Tapered Screw-Vent 3.3 / 3.7 / 4.1mm (3.5mm Ø)	180
Paragon Bio-Vent 4.5mm Diameter (4.5mm D)	Zimmer Screw-Vent / Tapered Screw-Vent 4.7mm Diameter (4.5mm Ø)	182
Paragon Core-Vent 4.3mm Diameter (3.5mm D)	Zimmer Screw-Vent / Tapered Screw-Vent 3.3 / 3.7 / 4.1mm (3.5mm Ø)	180
Paragon Core-Vent 5.3mm Diameter (4.5mm D)	Zimmer Screw-Vent / Tapered Screw-Vent 4.7mm Diameter (4.5mm Ø)	182
Paragon Micro-Vent 3.25mm Diameter (3.5mm D)	Zimmer Screw-Vent / Tapered Screw-Vent 3.3 / 3.7 / 4.1mm (3.5mm Ø)	180
Paragon Micro-Vent 4.25mm Diameter (4.5mm D)	Zimmer Screw-Vent / Tapered Screw-Vent 4.7mm Diameter (4.5mm Ø)	182
Paragon Swede-Vent (TL) 4.0mm	Nobel Branemark RP 3.75 / 4.1mm	161
Paragon Swede-Vent 4.0mm	Nobel Branemark RP 3.75 / 4.1mm	161
Paragon Swiss Plus 4.8mm	Straumann SynOcta (Tissue Level) Standard RN (4.8mmD)	176
Paragon Taperlock	Nobel Branemark RP 3.75 / 4.1mm	161
Park Dental Research Star Vent External Hex Screw (3.3)	Steri-Oss Hex Lock 3.25mm	
Park Dental Research Star Vent External Hex Screw (4.1)	Nobel Branemark RP 3.75 / 4.1mm	161
Park Dental Research Star Vent External Hex Screw (5.0)	Intra-Lock Threaded Conic 4.75/ 5.0mm Ex Hex	
Park Dental Research Star Vent External Hex Screw (5.0)	Intra-Lock Threaded Conic 4.75/ 5.0mm Ex Hex	
Renew Biocare Re-Root SD 3.5mm	Straumann SynOcta (Tissue Level) Standard NN (3.5mmD)	176
Restore / Sustain SD 3.3 mm External Hex	Steri-Oss Hex Lock 3.25mm	
Restore / Sustain SD 3.75 / 4.0 / 4.2mm External Hex	Nobel Branemark RP 3.75 / 4.1mm	161
Restore / Sustain SD 5.0mm External Hex	Intra-Lock Threaded Conic 4.75/ 5.0mm Ex Hex	
Southern 12 degrees 4.3 (3.5mmD)	Nobel Replace Tri-Lobe NP 3.5mm	163
Southern 12 degrees 5.0 (4.3mmD)	Nobel Replace Tri-Lobe RP 4.3mm	165
Southern 12 degrees 7.0 (5.0mmD)	Nobel Replace Tri-Lobe WP 5.0mm	168
Southern CoAxis OCT-XT / MAX-IT 4.0 / 5.0mm (4.8mmD)	Straumann SynOcta (Tissue Level) Standard RN (4.8mmD)	176
Southern CoAxis OCT-XT / MAX-IT 6.0mm (6.5mmD)	Straumann SynOcta (Tissue Level) Standard WN (6.5mmD)	178
Southern CoAxis TriNeck / TriMax 6.0 /8.0 /9.0 (6.0mmD)	Nobel Replace Tri-Lobe 6.0mm	170
Southern CoAxis TriNeck / TriMax NP	Nobel Replace Tri-Lobe NP 3.5mm	163
Southern CoAxis TriNeck / TriMax RP	Nobel Replace Tri-Lobe RP 4.3mm	165
Southern CoAxis TriNeck / TriMax WP	Nobel Replace Tri-Lobe WP 5.0mm	168
Southern Parallel / Tapered External Hex NP	Nobel Branemark NP 3.3mm	
Southern Parallel / Tapered External Hex WP	Biomet 3i Osseotite XP 5.0mm WP	
Steri-Oss (no-hex) Flat Top 3.8mm	Calcitek Integral 4.0mm	
Steri-Oss Hex Lock 3.8 / 4.5mm	Nobel Branemark RP 3.75 / 4.1mm	161
Sterngold Hex Cylinder 3.3 / 4.0mm	Nobel Branemark RP 3.75 / 4.1mm	161
Sterngold Hex Screw 3.75 / 4.0 / 5.0mm	Nobel Branemark RP 3.75 / 4.1mm	161
Sterngold IC 3.3 / 4.1 / 4.8mm	Straumann SynOcta (Tissue Level) Standard RN (4.8mmD)	176
Sustain 4.0 / 4.7mm Internal Bevel (flat top)	Calcitek Integral 4.0mm	

Compatibility Chart

SYSTEM	COMPATIBLE WITH:	PAGE
Sybron Hex Plus 3.5mm	Nobel Branemark NP 3.3mm	
Sybron Hex Plus 5.1mm	Nobel Branemark WP 5.0mm	163
Sybron Pitt Easy 3.8 (3.75mm D) (Yellow)	Sybron Pitt Easy 3.3 (3.25mm D) (Green)	
Sybron Pitt Easy 4.1 (4.0mm D) (Red)	Sybron Pitt Easy 3.3 (3.25mm D) (Green)	
Sybron Pitt Easy 4.9mm (Blue)	Sybron Pitt Easy 3.3 (3.25mm D) (Green)	
Uni-Dental Direct IN-SIX	Zimmer Screw-Vent / Tapered Screw-Vent 3.3 / 3.7 / 4.1mm (3.5mm Ø)	180

Torque Values			
SYSTEM	PROSTHETIC SCREW CONNECTION	PROSTHETIC SCREW THREAD	MANUFACTURER RECOMMENDED TORQUE
3i			
3i Certain Internal	0.048" (1.22mm) Hex	M1.6 X 0.35	20 Ncm
3i Certain External	Square	M2 X 0.40	32-35 Ncm
Ankylos			
C/X	1mm Hex	M1.8 x 0.35	15 Ncm
Astra			
Astra 3.0	0.050" (1.27mm) Hex	M1.4 X 0.30	15 Ncm
Astra 3.5-4.0 (Aqua)	0.050" (1.27mm) Hex	M1.6 X 0.35	20 Ncm
Astra 4.5-5.0 (Lilac)	0.050" (1.27mm) Hex	M2 X 0.40	25 Ncm
Astra EV 3.0, 3.6, 4.2, 4.8, 5.4	0.050" (1.27mm) Hex		25 Ncm
BioHorizon			
External, Internal, Internal Tapered	0.050" (1.27mm) Hex		30 Ncm
BlueSky Bio			
One Stage	Star & 0.048" (1.20mm) Hex		30 Ncm
Trilobe	Unigrip & 0.048" (1.20mm) Hex		30 Ncm
Internal Hex & Molar	0.050" (1.27mm) Hex		30 Ncm
Conus 12 & Three	0.050" (1.27mm) Hex		30 Ncm
Max	0.048" (1.20mm) Hex		30 Ncm
Quatro	0.048" (1.20mm) Hex		30 Ncm
Camlog ScrewLine			
3.3, 3.8, 4.3mm	0.050" (1.27mm) Hex	M1.6 x 0.35	20 Ncm
5.0, 6.0mm	0.050" (1.27mm) Hex	M2 X 0.40	20 Ncm
Endopore (Sybron)	0.050" (1.27mm) Hex		30 Ncm
Dentsply Fridament/Frialit & Xive	0.048" (1.20mm) Hex		24 Ncm
Hiossen			
mini	0.048" (1.20mm) Hex	M1.6 X 0.35	20 Ncm
standard	0.048" (1.20mm) Hex	M2 X 0.40	30 Ncm
Implant Direct			
Legacy	0.050" (1.27mm) Hex	M1.6 x 0.35	30 Ncm
Keystone			
Keystone PrimaConx	Square	M1.8 X 0.35	30 Ncm
SD Restore	0.048" (1.20mm) Hex, Square	Square 1-72 UNF	30 Ncm
RD Restore	0.048" (1.20mm) Hex, Square	M2 x 0.40	30 Ncm
WD Restore 0.048" (1.22mm) Hex, Square	0.048" (1.20mm) Hex, Square	M2.5 X 0.45	30 Ncm
Keystone Renova	0.048" (1.20mm) Hex	M1.8 x 0.35	30 Ncm

Torque Values

SYSTEM	PROSTHETIC SCREW CONNECTION	PROSTHETIC SCREW THREAD	MANUFACTURER RECOMMENDED TORQUE
Megagen			
Anyridge	0.048" (1.20mm) Hex	M1.8 x 0.35	25 Ncm
Neodent	0.048" (1.20mm) Hex	M1.8 x 0.35	32 Ncm
Neoss	Neoss Proprietary	M2 X 0.40	32 Ncm
Neodent			
	0.048" (1.20mm) Hex	M1.8 x 0.35	32 Ncm
Neoss			
	Neoss Proprietary	M2 X 0.40	32 Ncm
Nobel Biocare			
Active 3.0	Unigrip	M1.4 X 0.30	15 Ncm
Active NP	Unigrip	M1.6 X 0.35	35 Ncm
Active RP/WP	Unigrip	M2 X 0.40	35 Ncm
Branemark NP	Unigrip	M1.6 X 0.35	35 Ncm
Branemark RP	Unigrip	M2 X 0.40	35 Ncm
Branemark WP	Unigrip	M2.5 X 0.45	35 Ncm
Replace NP	Unigrip	M1.8 x 0.35	35 Ncm
Replace RP	Unigrip	M2 X 0.40	35 Ncm
Straumann Tissue-level			
Narrow Neck SCS	SCS	M1.8 x 0.35	35 Ncm
Regular Neck SCS	SCS	M2 X 0.40	35 Ncm
Wide Neck	SCS	M2 X 0.40	35 Ncm
Straumann Bone-level			
Narrow Cross-fit SCS	SCS	M1.6 x 0.35	35 Ncm
Regular Cross-fit SCS	SCS	M1.6 x 0.35	35 Ncm
Zimmer ScrewVent			
	0.050" (1.27mm) Hex	1-72 UNF	30 Ncm

Thank you to all of our partners who shared these pictures and allowed them to be included. This section is intended to assist the community of restorative Dental Implant Professionals identify unknown implants and provide the best possible service to our client, the patient. We hope this is a valuable resource to you. ---Your Partners at the PREAT Technical Staff

Bicon Implant System



BioHorizon External 3.5mm



BioHorizon External 4.0mm

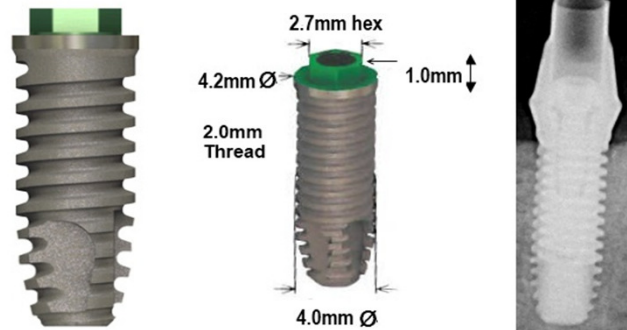

BioHorizon External 5.0 / 6.0mm

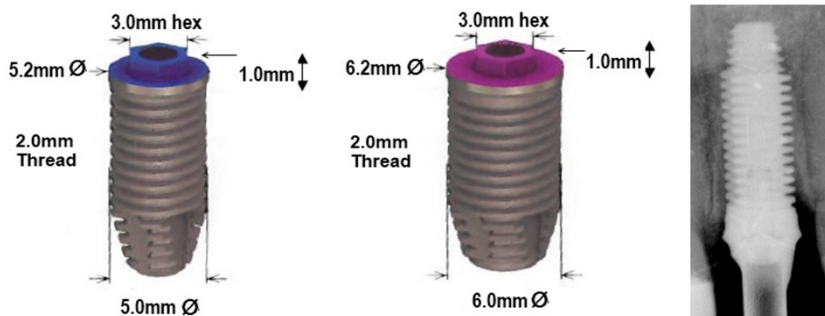

BIO-LOK IC (Silhouette)



BIO-LOK Implant System

Internal Connection
(Silhouette)



BTI Externa Wide Platform

Externa Wide Platform Implants

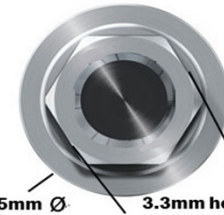

Branemark NP 3.3mm

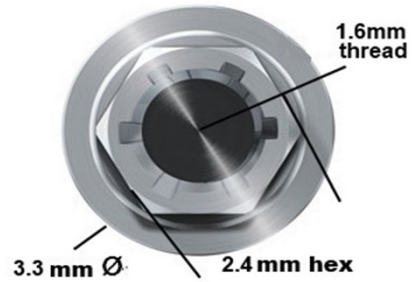

Calcitek Integral 3.25mm

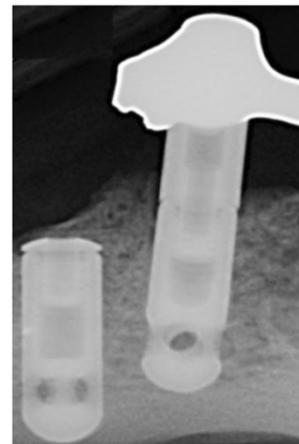
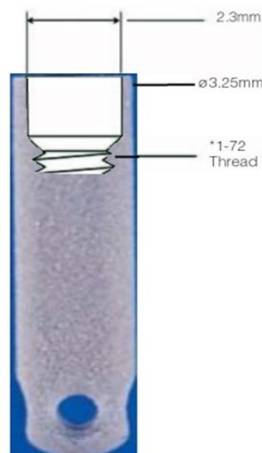

Calcitek Integral 4.0mm

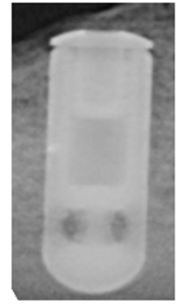
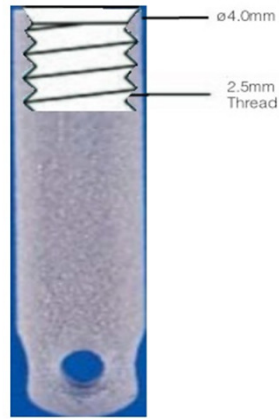

CALCITEK OMNILOC 3.25mm

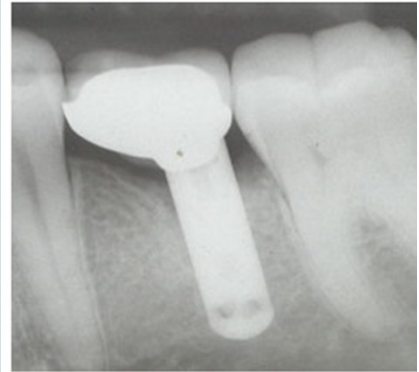

CALCITEK OMNILOC 4.0mm



Calcitek Spline 3.25mm

6 1mm tall splines



Calcitek Spline 3.75 / 4.0mm

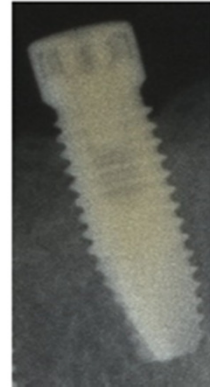
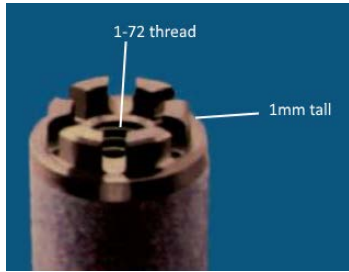

Calcitek Spline 5.0mm

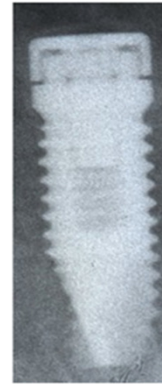

Dentsply Ankylos and Ankylos CX

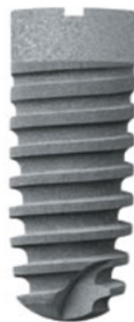

Ankylos C (non-indexed) Implant
Ankylos CX (indexed) Implant
3.5mm / 4.5mm / 5.5mm



Internal Morse Taper
Internal Spline (6) (CX only)

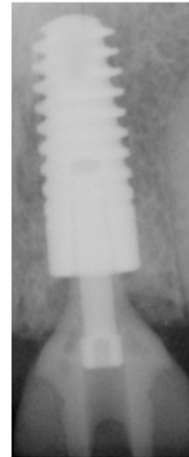

Dentsply Xive 3.4mm



Xive 3.4mm Implant



Dentsply Xive 3.8mm

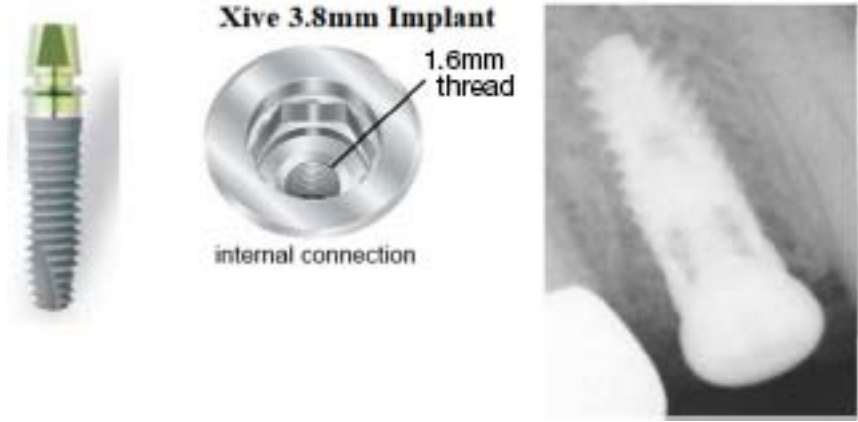

Dentsply Xive 4.5mm

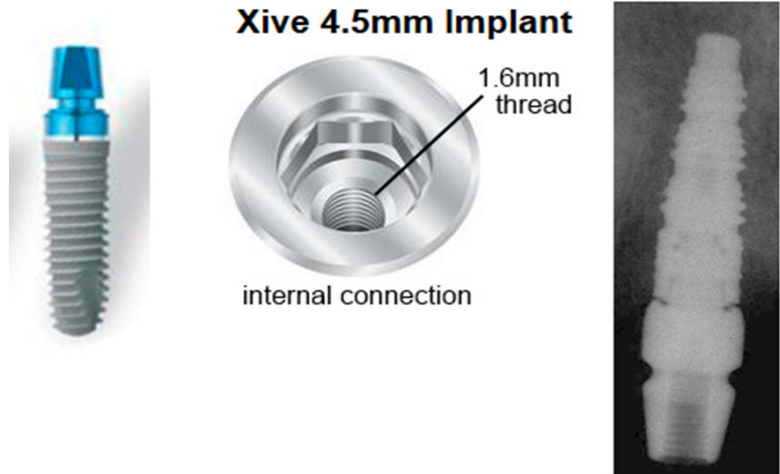

Dentsply Xive 5.5mm

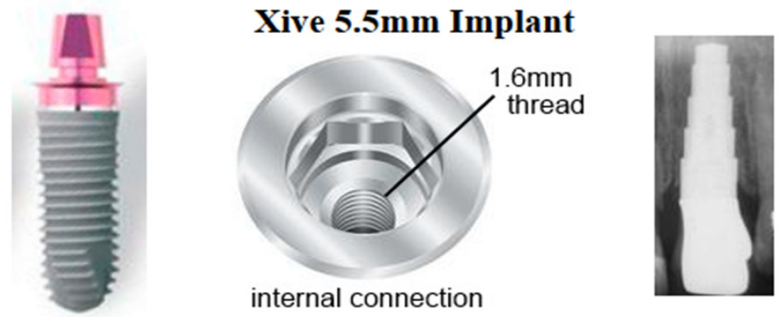

DSI SM Submerged 3.8/4.1mm

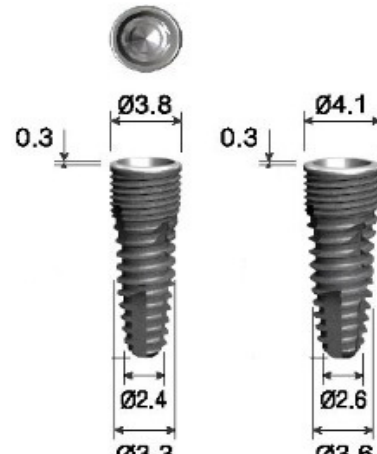

Implant Direct SwishPlant / SwishPlus 3.3mm (3.7mmD)

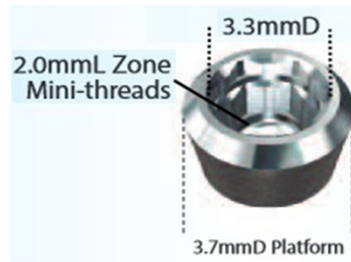

Implant Direct ScrewPlant / ScrewPlus 3.7mmD

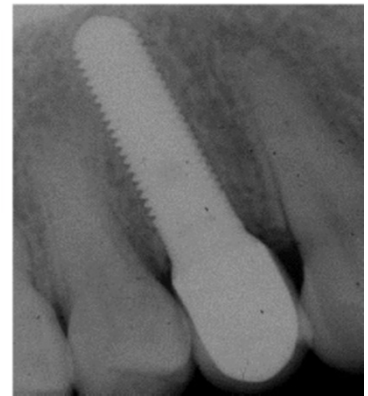

Implant Direct ScrewPlant / ScrewPlus 4.7mmD

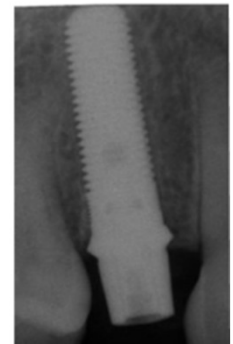

Implant Direct ScrewPlant / ScrewPlus 5.7mmD

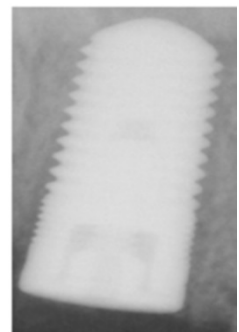

Implant Direct ScrewPlant / ScrewPlus 6.5mmD

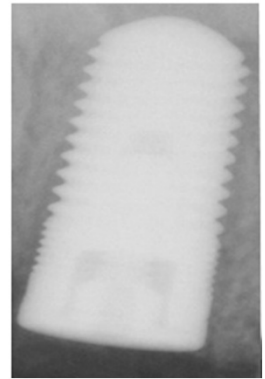

Implant Direct ScrewIndirect 3.0 / 3.7 / 4.7 / 5.7mm (5.0mmD)

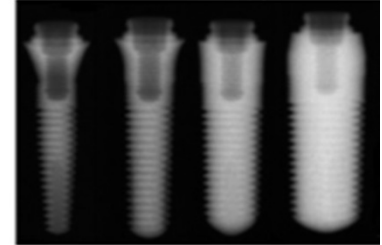
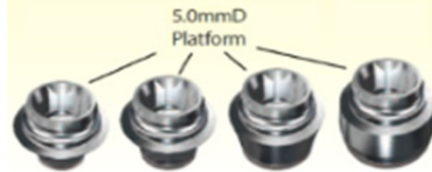

IMZ 3.3mm Non-Hex Twin Plus

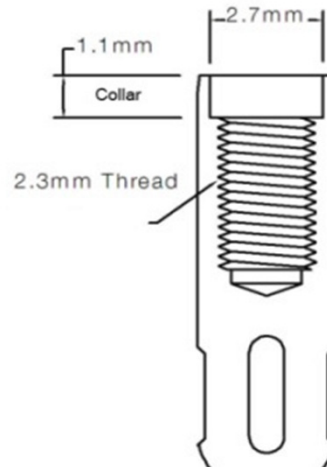

IMZ 4.0mm Non-Hex Twin Plus

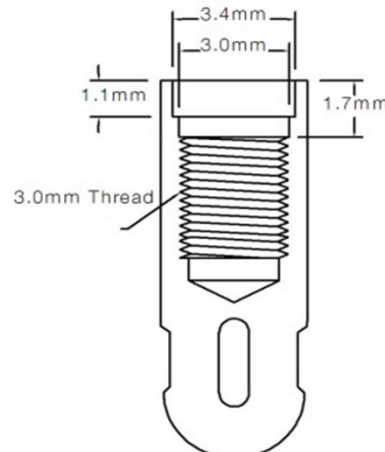

Imtec 3.3mm external Hex Head



Imtec Endure 4.3mm Internal



Endure 4.3mm Internal
Internal Hexagon



Intra-Lock 3.3mm External Hex

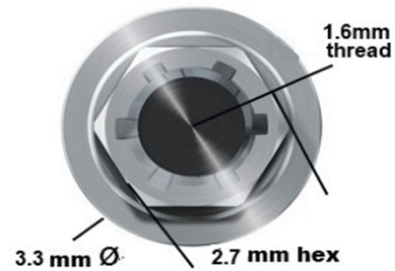
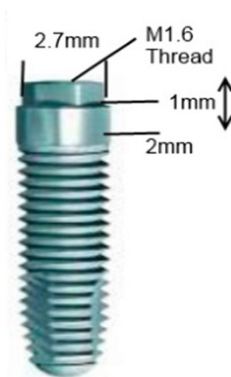

Intra-Lock Threaded Conic 4.3mm Ex Hex

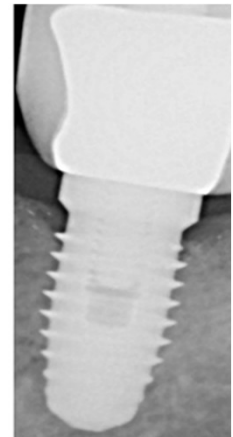
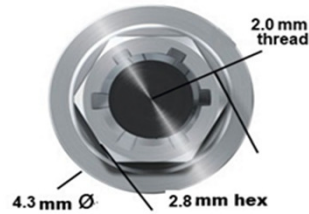

**Intra-Lock Threaded Conic 4.75/ 5.0mm Ex Hex
Restore / Sustain SD 5.0mm External Hex**

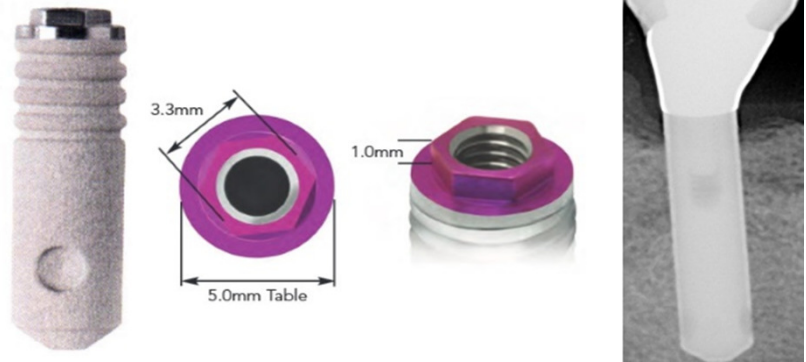

Innova Endopore 3.5mm / Entegra 3.25 - 3.5mm (0.9mm) External Hex

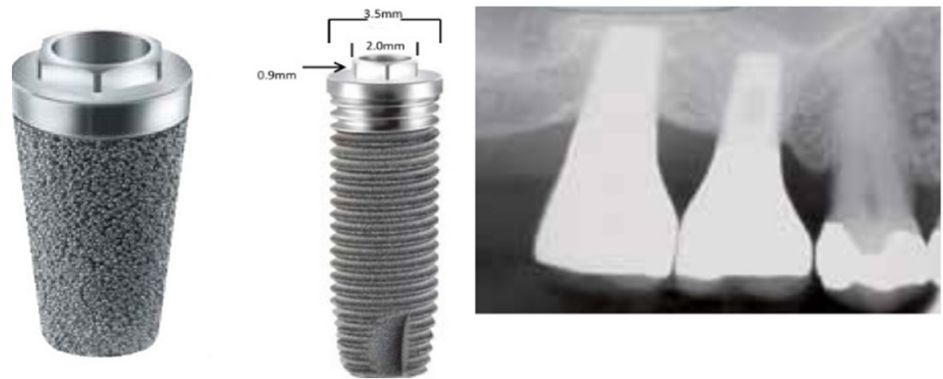

Innova Endopore 5.0mm / Entegra 4.7mm (0.9mm) External Hex

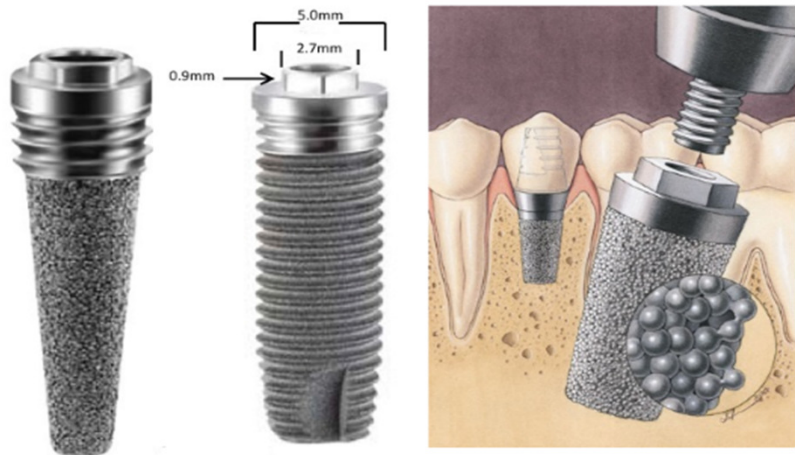

Innova Endopore 4.1mm Internal Hex

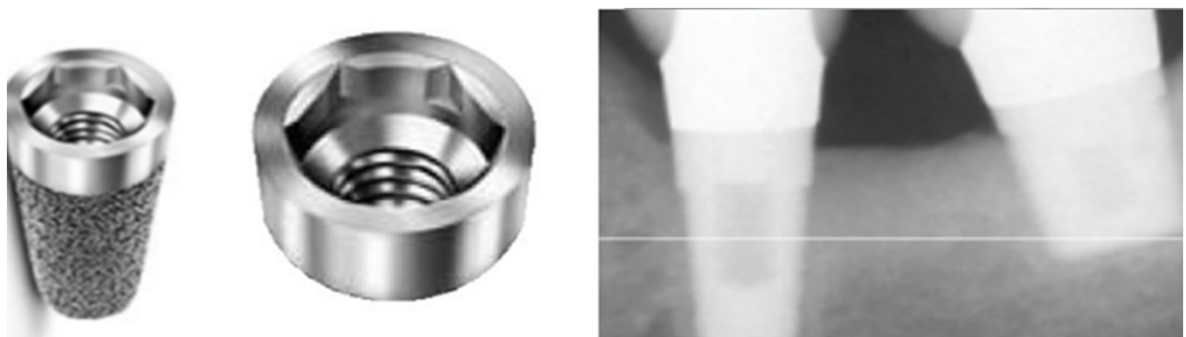

Innova Endopore 5.0mm Internal Hex



Innova Pro Series XRT Bone Level 3.5mm

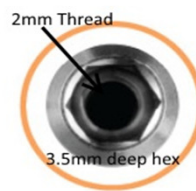

Innova Pro Series XRT Bone Level 4.1mm

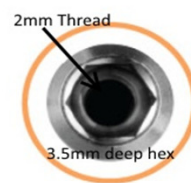

Keystone Genesis 4.0 / 5.0 / 6.0mm

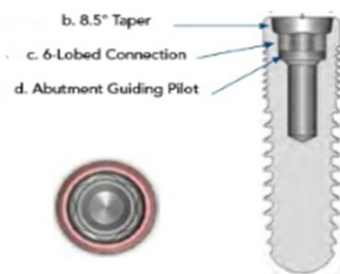

Keystone PrimaConnex 3.5mm

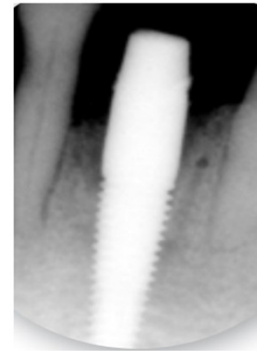

Keystone PrimaConnex 4.1mm

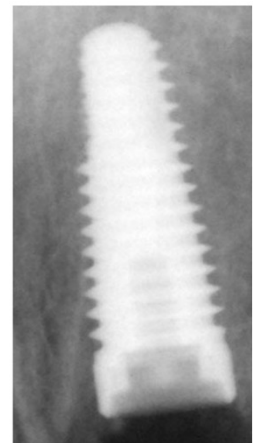

PrimaConnex 5.0mm

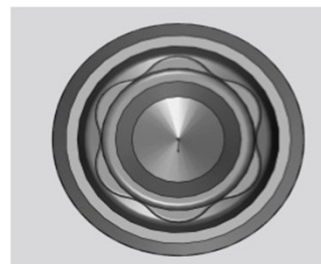

Kyocera Physio Odontram Implant (POI)

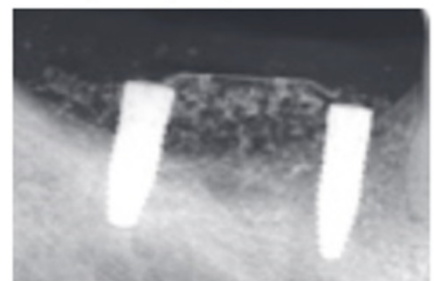
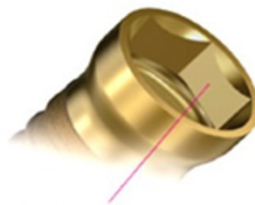
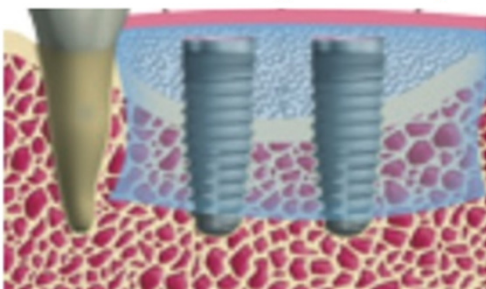

MIS C4 / Seven 3.30mm

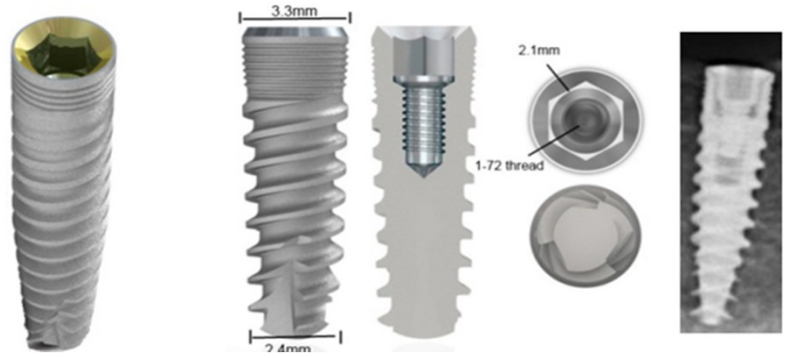

**OsseoLink Global Implant Solutions OctaCone
3.5 (red), 4.0 (yellow), and 5.0mm (green)**

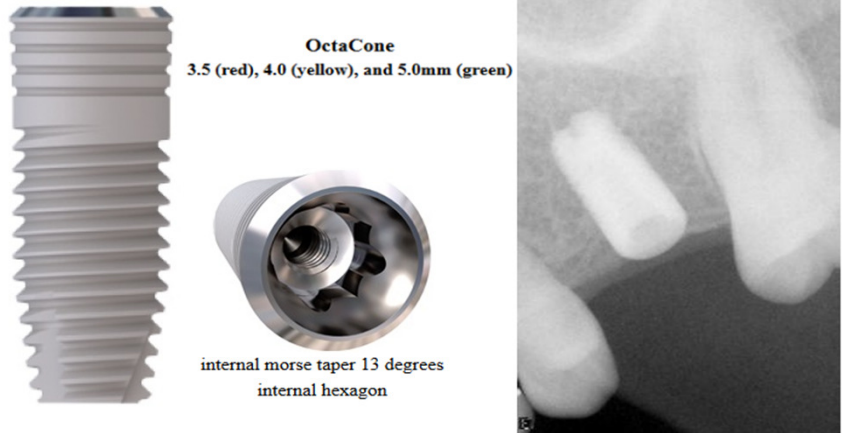

Paragon Swiss Plus 3.8mm

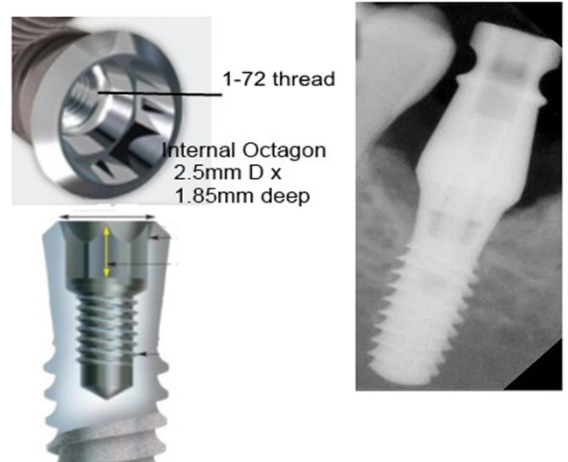

Renova SDI (straight and tapered) 3.75mm Internal Hex



Renova RDI (straight and tapered) 4.5mm Internal Hex



Restore / Sustain SD 3.3 mm External Hex



Sustain 4.0 / 4.7mm Internal Bevel (flat top)



Sargon Implant 3.8mm External Hex

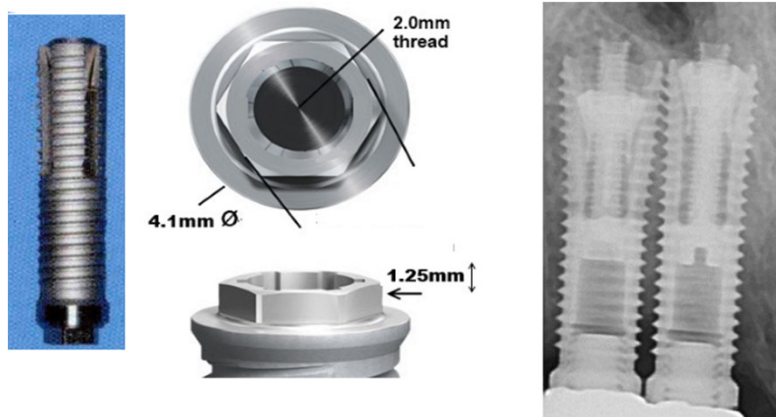

Southern Parallel / Tapered External Hex NP

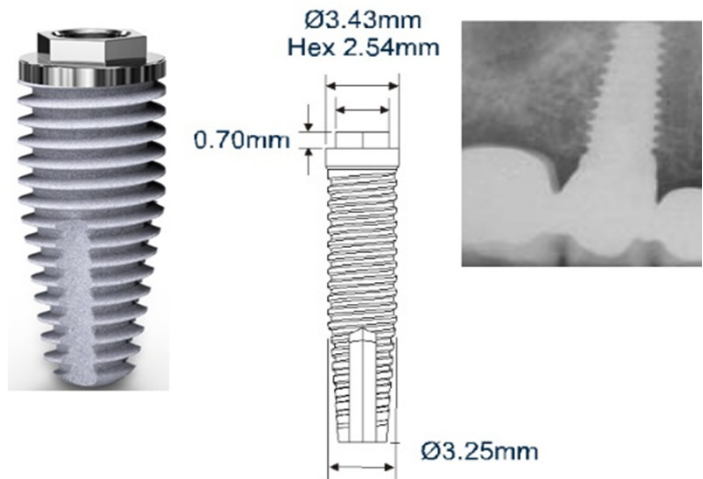

Steri-Oss Hex Lock 3.25mm



Steri-Oss Hex Lock 5.0mm

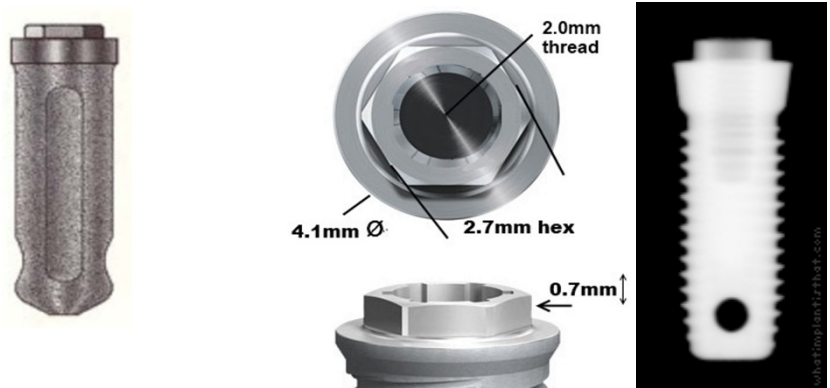

Steri-Oss (no-hex) Flat Top 3.8mm

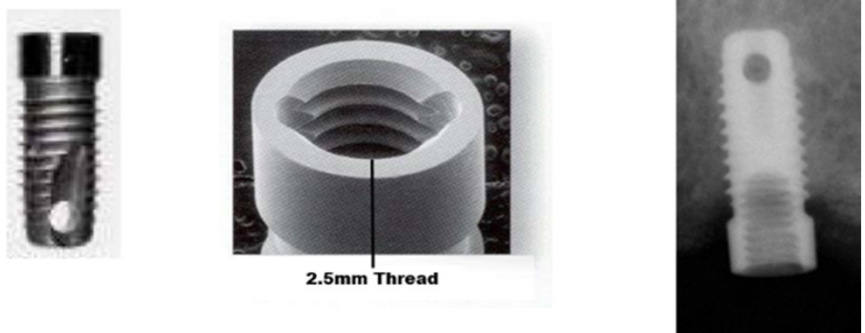

Steri-Oss Replace Ex Hex 3.5mm

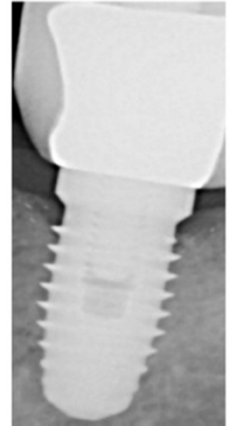
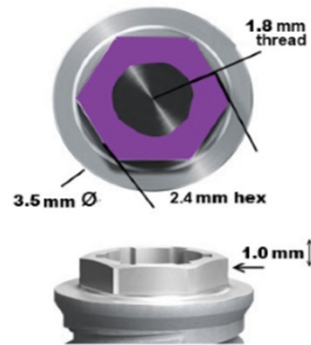
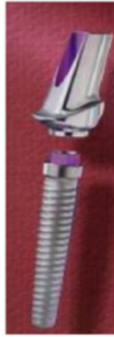

Steri-Oss Replace Ex Hex 4.3mm

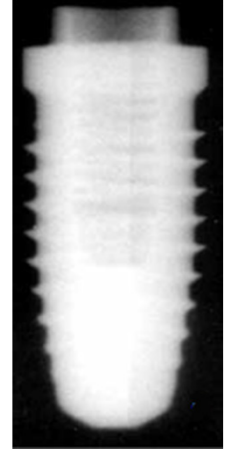
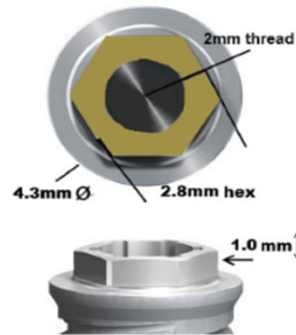

Steri-Oss Replace Ex Hex 5.0mm

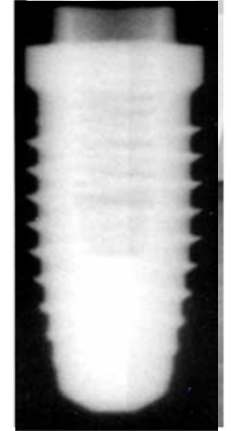
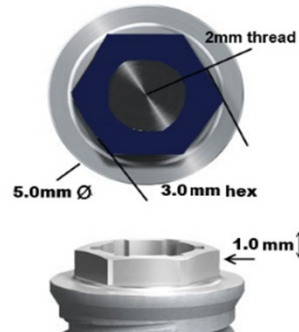

Straumann Narrow Neck Crossfit (Tissue Level) NNC (3.5mmD)

Narrow Neck Crossfit (Tissue Level) NNC (3.5mmD)

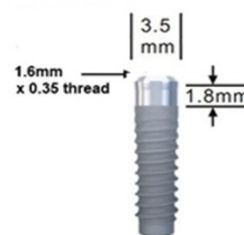

- Sybron Pitt Easy 3.3 (3.25mm D) (Green)
- Sybron Pitt Easy 3.8 (3.75mm D) (Yellow)
- Sybron Pitt Easy 4.1 (4.0mm D) (Red)
- Sybron Pitt Easy 4.9mm (Blue)

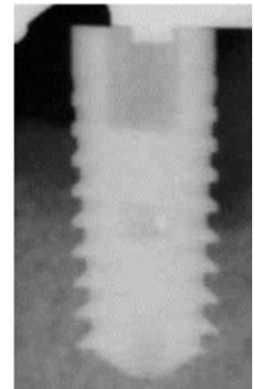
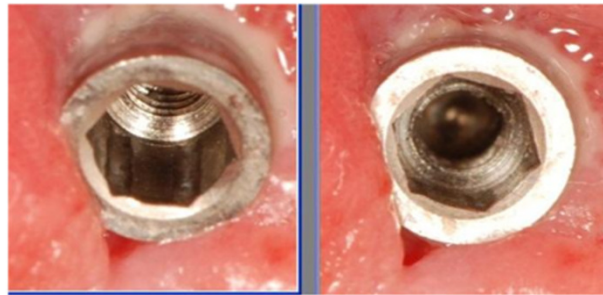

Zimmer Advent 3.7 / 4.7mm (4.5mm D platform)

3.0mm
internal hex

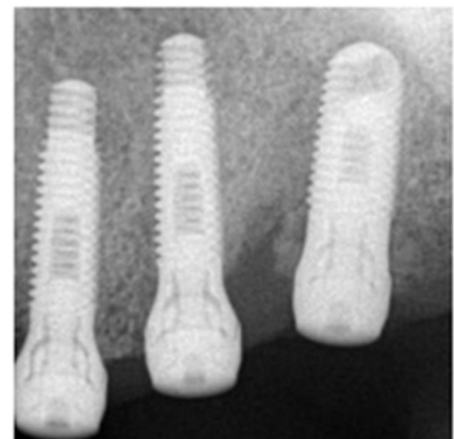

OUR GUARANTEE

Preat components are available for use with a variety of implant systems of other manufacturers. Preat will honor the OEM implant manufacturer's warranty when using our high-quality implant components.

Preat Corporation's Quality Control and Manufacturing Standards meets or exceeds state, federal and international regulations and our QMS is certified to ISO 13485:2016

Preat is licensed through the California FDA, US FDA, Health Canada and is currently in the process of achieving its CE mark.

TERMS + CONDITIONS

- Prices are subject to change without notice.
- Orders may be sent "Cash On Deliver" (COD) or with prior Credit Card payment. Purchaser is responsible for Shipper return fee for refused COD shipment.
- Preat accepts all major credit cards.
- Other terms and conditions may apply. Please contact Preat for more information:

Preat Corporation Corporate Headquarters
2625 Skyway Drive, Suite B, Santa Maria, CA 93455 USA

1-800-232-7732

Hours of Operation:

Monday – Friday 7:30am – 4:30pm PST

TRADEMARKS + AFFILIATIONS

Preat Corporation components are available for use with a variety of implant systems of other manufacturers.

SPECIAL MENTION

Special mention is made in this catalog of Preat's components that are available and compatible for Straumann® ITI®, Straumann® CrossFit®IMZ™, Biomet®3i's Osseotite®, Miniplant® & Nanotite®, and Zimmer® Screw-Vent®, Zimmer® Tapered Screw-Vent®, and Nobel Biocare®'s NobelReplace®, Nobel Biocare® Branemark®, Nobel Active®, NobelReplace® Select, CAMLOG®, Dentsply Astra®, Implant Direct® RePlant®, RePlus®, ReActive®, Legacy®, ScrewPlant®, ScrewPlus®, SwishPlant® and ScrewIndirect® implant systems. These implant names and implant manufacturers and all others mentioned in the catalog are trademarks of their respective manufacturer and not of Preat Corporation.

UNAFFILIATED

Preat is not affiliated or associated with any of the following companies: Straumann® ITI®, Nobel Biocare®, Zimmer Dental®, IMZ™, CAMLOG®, Dentsply®, Zest Anchors® and Biomet® 3i®.

OTHER TRADEMARKS

BioHorizons® is a federally registered trademark of BioHorizons Implant Systems, Inc., Birmingham, AL

Biomet® is a federally registered trademark of Biomet, Inc.

3i® is a federally registered trademark of Biomet 3i, LLC, Palm Beach Gardens, FL

Certain® & Certain® PREVAIL® are federally registered trademarks of Biomet 3i, Warsaw, IN

Osseotite® is a federally registered trademark of Biomet 3i, LLC, Palm Beach Gardens, FL

Miniplant® is a federally registered trademark of Biomet 3i, LLC, Palm Beach Gardens, FL

Nanotite® is a federally registered trademark of Biomet 3i, LLC, Palm Beach Gardens, FL

IMZ™ is a common law trademark of IMZ GmbH, Germany.

LOCATOR® is a federally registered trademark of Zest Anchors, Inc.

LOCATOR RTx® is a federally registered trademark of Zest Anchors, Inc.

LOCATOR FTx® is a federally registered trademark of Zest Anchors, Inc.

Nobel Biocare® is a federally registered trademark of Nobel Biocare Services AG, Zurich, Switzerland.

Branemark™ is a common law trademark of Nobel Biocare AG, Zurich, Switzerland.

NobelReplace® is a federally registered trademark of Nobel Biocare AB JOINT STOCK COMPANY, Sweden

Straumann® is a federally registered trademark of Straumann Holding AG Corp, Switzerland

ITI® is a federally registered trademark of Straumann Holding AG Corp, Switzerland

Zimmer® Screw-Vent®, & Zimmer® Tapered Screw-Vent® are federally registered trademarks of Zimmer Dental, Inc., Carlsbad, CA

Zimmer® is a federally registered trademark of ZimmerTechnology, Inc., Warsaw, IN

COPYRIGHT

No part of this publication may be reproduced, stored in a retrievable system, or transmitted in any form, by any means, electronic, mechanical photocopying or recording, including translating it into another language without the written and signed permission of an officer of Preat.

© Copyright 2019 Preat, Santa Maria, CA USA

preat.com
1-800-232-7732

Order # _____

Lab Name _____

Address _____

Phone # _____

Email _____

Contact Name _____

Case Design Materials

- Maxillary Mandibular

Bar Design

- Hybrid Attachment Bar
 Ceramic Bridge Bridge w/Preparations

Alloy Type

- Titanium Cobalt-Chrome

Process

- Additive 5-axis milling

Implant Information

- Good Bone Fair Bone
 Poor Bone

Number of Implants _____

Type / Platform _____

- 3I Biomet _____
 Astra _____
 Biohorizons _____
 Camlog _____
 Implant Direct _____
 IMZ _____
 Keystone _____
 Nobel Bio. _____
 Straumann _____
 Zimmer _____
 Other: _____

Materials Supplied

- Denture Setup Soft tissue Master Cast
 Verification Jig Labial Key / Putty Matrix
 Other: _____

Ship to:

Preat Corporation
2625 Skyway Drive, Suite B
Santa Maria, CA 93455

- Call for Consultation

Bar Design

- Locator Universal Plunger Lock
 Hader Ceka M2 / M3
 Preci Clix Dolder Rigid Mini / Std
 Preci Vertex Dolder Resilient Mini / Std
 Preci Ball Round Bar / Preci Clip

Number of Implants _____

Bar Design Specifics

Distal Extension _____ Mesial Extensions _____

Space Between Bar and Tissue _____

Bar Height _____ Hybrid Retention Elemnts? _____

Additive Manufacturing

Increased surface retention for Hybrid? Yes / No



Additional Information

Opposing Dentition _____

Patient Issues _____

Additional Instructions:

Please outline the desired design:

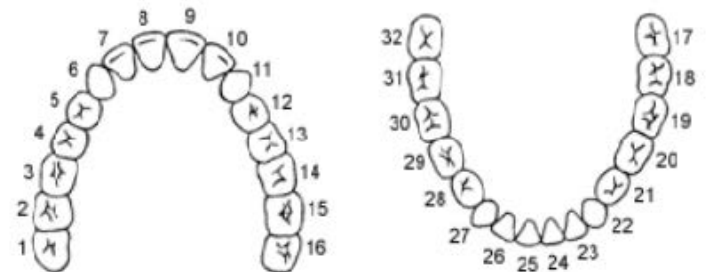

THE PRISM

DESIGN & MANUFACTURING CENTER

FROM IDEAL
TO EXTREME,
AND
EVERYTHING
IN BETWEEN.

- **Primary and Secondary Structures in Grade 23 Titanium or Cobalt Chrome**
- **Fixed Detachables with polished and/or Pearl retentive surface, angle correction up to 28 degrees**
- **Overdenture Bars with Attachments**
(up to 4 Locator, Hader, Plunger Loc, Sagix, Clix, Ceka attachments free of charge)
- **Designed by Technicians for Technicians—**
our design Technicians average 20 years at the bench

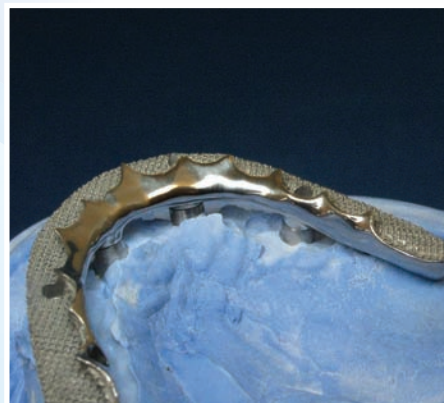
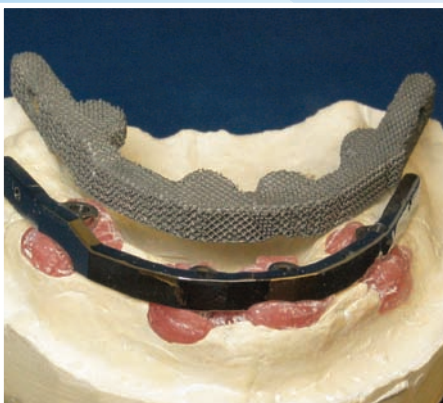
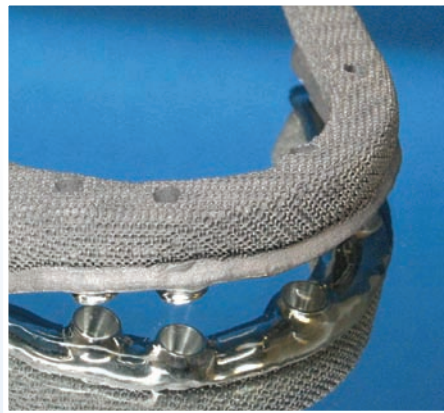
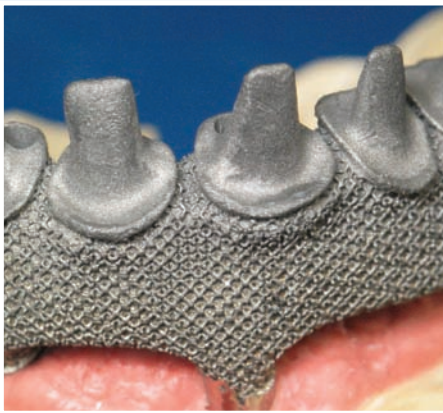



RESTORATIVE PROSTHETIC PRODUCT BOOK

We would like the opportunity to supply you with your precision attachment, implant, and prosthetic specialty needs.

You and your staff will receive prompt, courteous service, the best technical assistance, greater options for your dental implant and attachment cases, and competitive pricing by a business and staff who want and appreciate your business.

We look forward to partnering with you.

Preat.com | Phone 1-800-232-7732

WITHIN THE USA CUSTOMER SERVICE

7:30am - 4:30pm PST
1 (800) 232-7732
FAX (805) 202-3076
Preat.com

OUTSIDE THE USA CUSTOMER SERVICE

7:30am - 4:30pm PST
1 (805) 202-3070
FAX (805) 202-3076
Preat.com

TECHNICAL SUPPORT

technical@preat.com

CUSTOMER SUPPORT

info@preat.com

ORDERS

orders@preat.com