



ZAAG Direct Placement

Zest Anchor™ Advanced Generation Fabrication Instructions

INDICATIONS: Overdentures and Partial Dentures: use when non-vital roots or implants are utilized as retaining abutments. The female may be directly placed into a root, or a coping may be cast against the female. Implant abutment females are also available.

CONTRAINDICATIONS: Not appropriate where a totally rigid connection is required.

FEATURES:

- Subgingival connection results in low application of forces near the root center of support--Abutment preservation.
- Increased surface areas on both the nylon male and metal female allow for longer attachment life--Reduced servicing.
- Instant removal and replacement of males--Eliminates oral chairside male pickup.
- Universal joint stress relief with vertical resiliency--Abutment preservation.



Denture Cap Male



Direct Placement Female



Impression Male



Analogue Female



Replacement Male



Parallel Post



One Step Drill

Direct Placement of the Female

1. Prepare and measure study casts to determine if adequate vertical space is available, and make selection of regular or mini size attachment.



For **regular size**, space must equal or exceed the following:

- Width of root surface: 4.0mm
- Distance from root surface to opposing dentition: 4.5mm

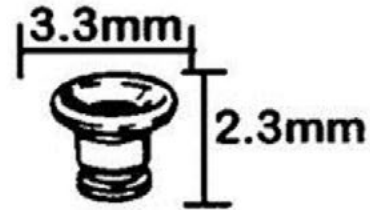

For **mini size**, space must equal or exceed the following:

- Width of root surface: 3.5mm
- Distance from root surface to opposing dentition: 3.5mm

2. Decoronate the root and complete endodontic therapy. The coronal surface of the root should be prepared as low as possible.

The canal may be prepared for the female using one of two techniques.

#1. Technique for the use of Carbide Burs and Sizing Diamonds

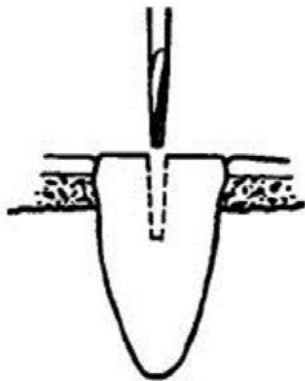

1

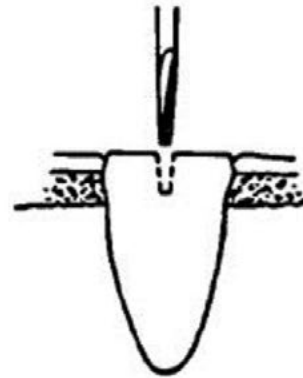

2

3. Drill a pilot hole with a #700 carbide bur to a depth of **4mm** for a **regular size female**. Alignment of the drill should follow the path of insertion of the denture. The pilot hole need not follow the root canal (**Fig1**). For a **mini size female** drill the pilot hole to a **depth of 2mm** (**Fig 2**).

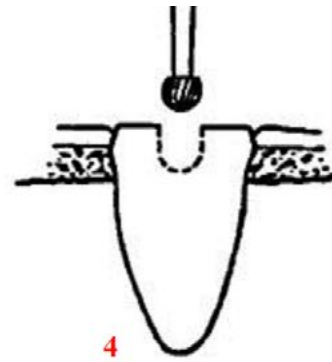
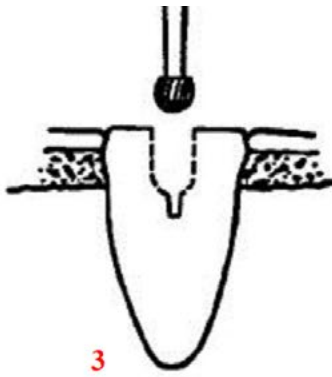

4. Enlarge the pilot hole with a #8 round carbide bur to a depth of 3mm (Fig 3) for a regular size female, and to a depth of 2mm for a mini size female (Fig 4).

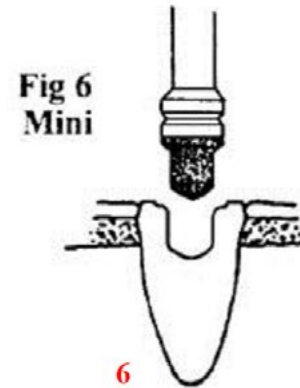
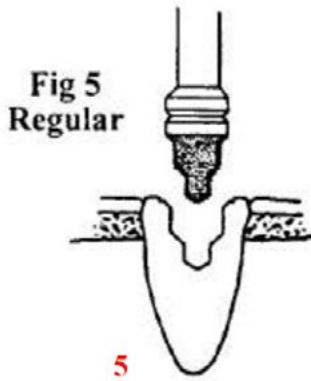

5. Complete the preparation for the surgical stainless steel female with the ZAAG Diamond Sizing Bur (standard or mini). The Diamond Sizing Bur should be used to a depth where a full 360° recessed seat is created on the occlusal surface of the root (Fig 5 & 6). This will assure a firm seating of the female and a proper seal. Keep the Diamond Bur rotating throughout this entire procedure, including insertion and removal of the instrument, to prevent breakage of the tip. Use plenty of water as coolant during the process.

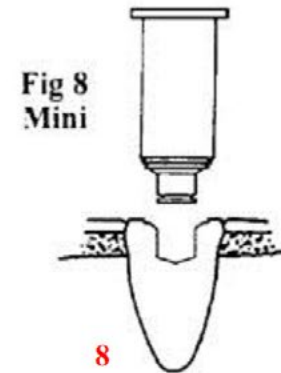
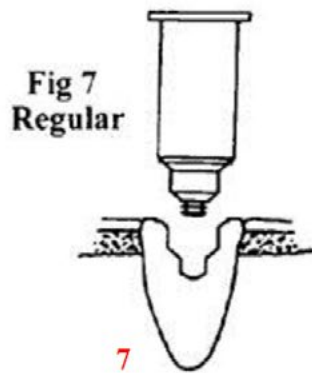

6. Using the ZAAG Parallel Post as a handle, try in the metal female to check for proper fit (Fig 7 & 8). When placing multiple attachments, use the metal female try-in with Parallel Post as a guide to create the following pilot holes parallel to the first preparation.

7. Cement the metal female component in place with composite resin cement or cement of choice.

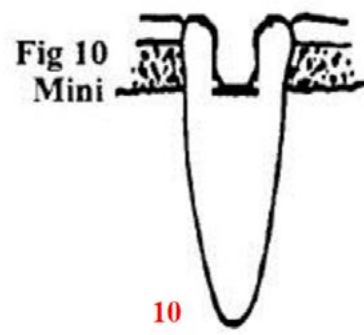
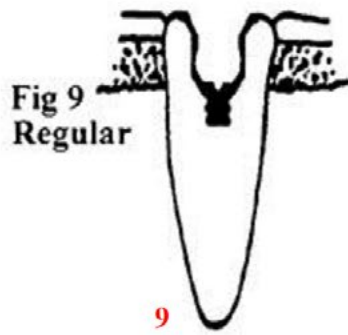

8. After the cement has set, round off and polish the root surface from the metal flange to the tissue (Fig 9 & 10).

Important note: It is imperative that the root surface immediately surrounding a ZAAG attachment be finished down the exact level or lower than the top of the female. This will allow the ZAAG male with centering sleeve to seat completely in the female.

#2. Technique using the ZAAG One-Step Drill

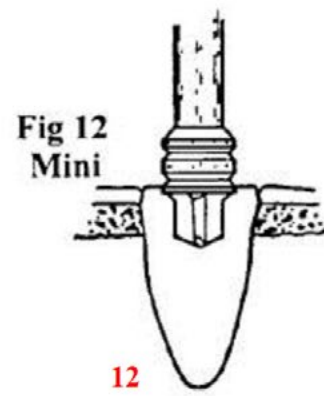
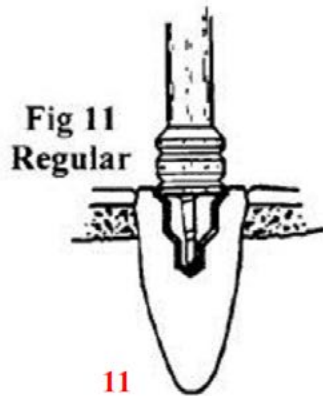

1. Complete the reduction of the non-vital teeth to the gingival level.
2. The ZAAG One-Step Drill is self starting and pilot holes are not necessary.
3. At slow speed (750 RPM), drill a hole with the drill to a depth where a full 360° recessed seat is created on the occlusal surface of the root. This will assure firm seating of the female and facilitate a proper seal. Water should be used generously when cutting with the ZAAG One-Step Drill (Fig 11 & 12).

Placement of the Male Anchor

The male may be incorporated into the prosthesis by the laboratory during processing, or secured in position by the dentist chairside using self-curing acrylic resin.

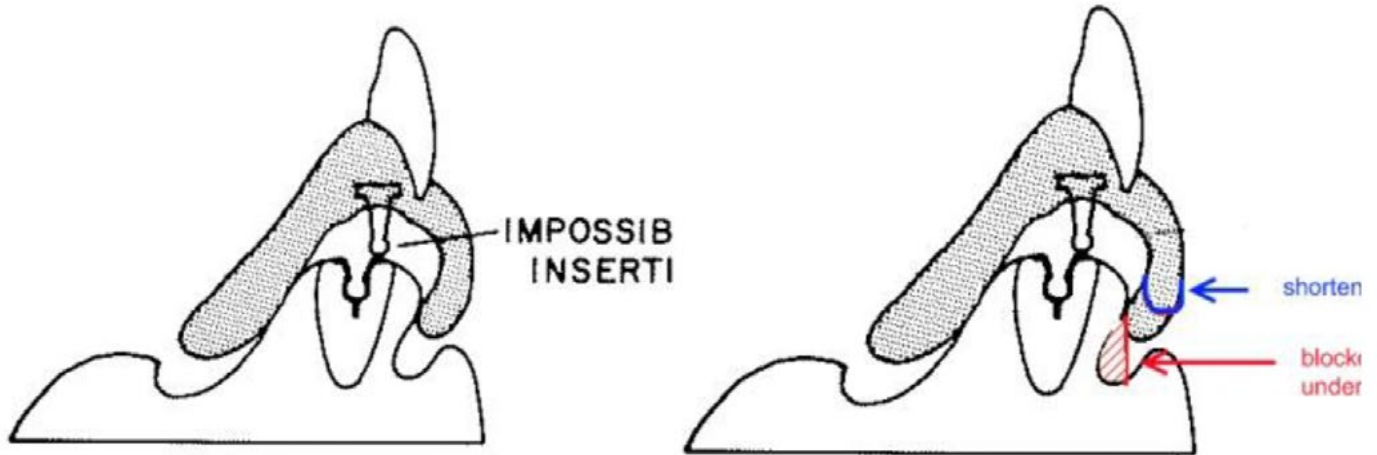

Please note the importance of blockout all undercuts and/or utilizing a short flange in the anterior region when working with the ZAAG attachment. Appliances designed to engage the labial undercut will interfere with the proper seating and not allow proper alignment of the attachment during insertion. This may lead to bending or breakage of the nylon males.

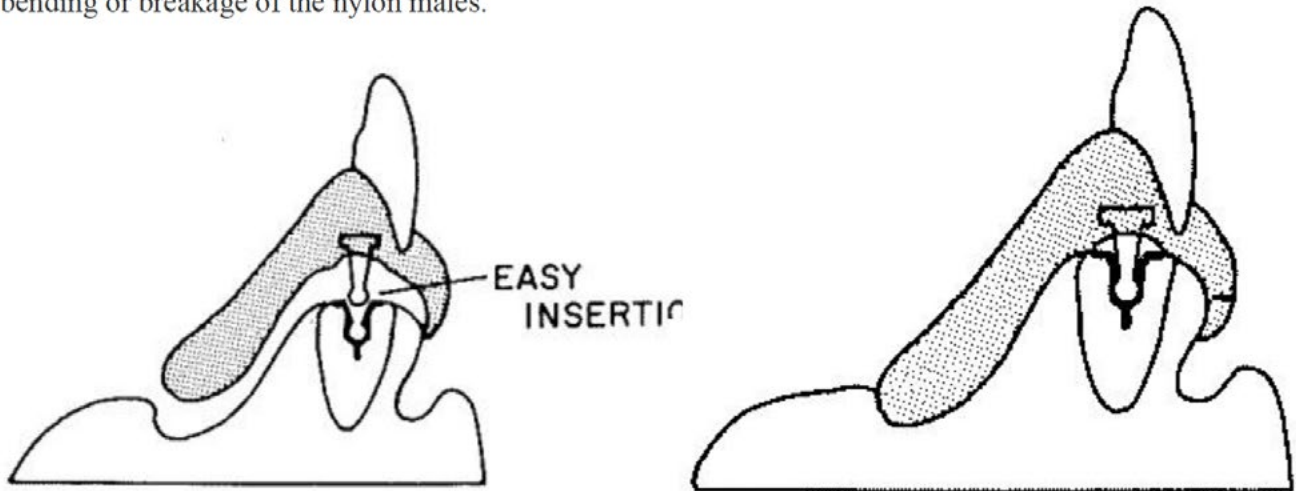

The ZAAG attachment provides excellent retention and eliminates the need to engage the labial undercut for retention. We strongly advocate keeping the labial flange short to allow proper seating of the attachments.

Male Placement by the Laboratory

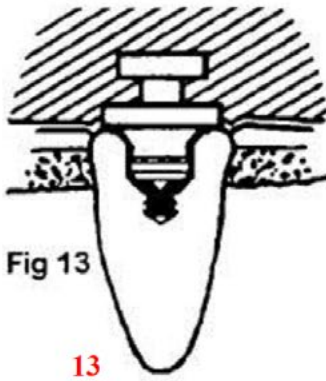

Fig 13

13

1. Cementation of the metal females and final root contouring is completed in the dental office.

2. Place an Impression Male in the metal female cemented in the oral cavity. Make sure you feel a positive snap, indicating the Impression Male is fully engaged. The male should seat flush on the flange of the metal female component (**Fig 13**).

3. Make impression exercising caution not to compress the soft tissue. The Impression Males are designed with minimum retention to be drawn in the impression.

Note: a rubber base impression material may easily pick up the Impression Males. If an alginate material is preferred, retention of the Impression Males may be reduced by using a blade to cut off a small section of its retentive band.

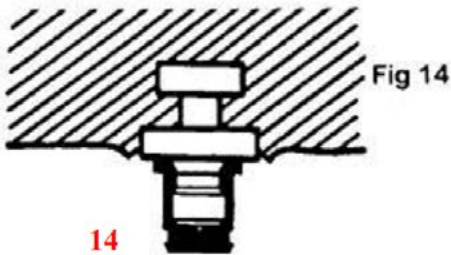

Fig 14

14

4. Substitute Model Females are placed over the Impression Males in the impression. Make sure the Substitute Female is fully seated (**Fig 14**).

5. Pour the Master Model. The Substitute Females are now part of the Master Model as an accurate transfer of the position of the female attachments in the oral cavity.

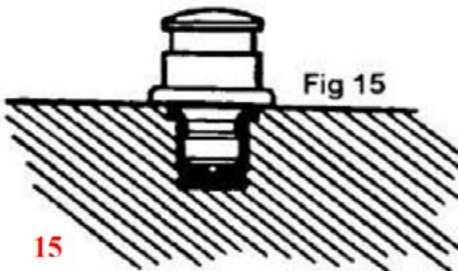

Fig 15

15

6. Place the male (stainless steel cap, nylon male, and centering sleeve) into each Substitute Female. The centering sleeve eliminates movement of the male during processing (**Fig 15**).

7. Complete processing of denture base material in the technique of choice.

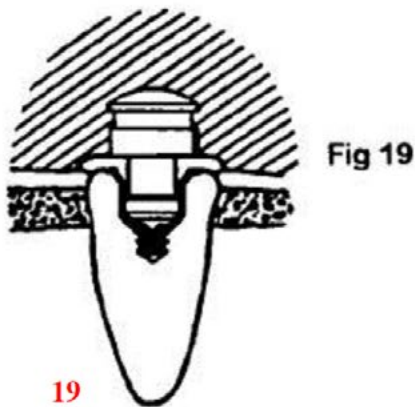
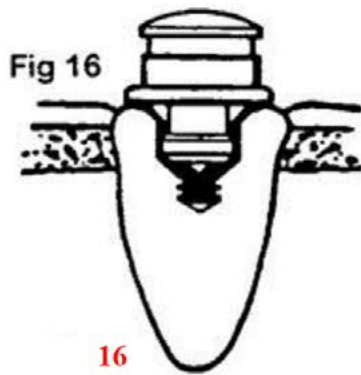

Fig 19

19

8. Remove the centering sleeves from the males and remove any acrylic over the remaining root surface. There should be no contact between the root and acrylic saddle or base (**Fig 19**).

Male Placement by the Dentist



1. Cementation of the metal females and the final root contouring is completed.

2. Snap a male (stainless steel cap, centering sleeve, and nylon male) into each cemented female (**Fig 16**). Double check the retention of each male by removing it and inserting it back into the cemented female.

Note: ZAAG males are designed with a retentive fit of 2.5 lbs. If reduced retention is desired, cut off a small section of the retentive band of the ZAAG male.

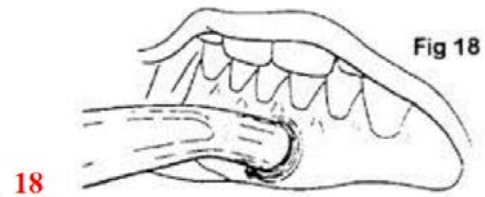
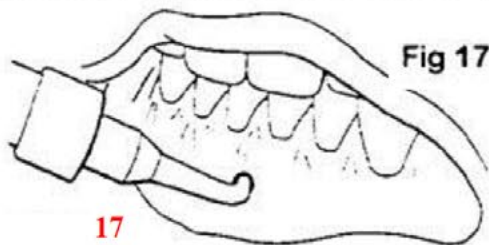

3. Prepare a recess in the denture to accommodate the protruding ZAAG male. There must be no contact between the denture and the metal cap. If the denture rests on the male component, excess pressure on the root will result.

NOTE: It is always recommended that a vent, or "escape vent", is cut into the lingual side of the prosthesis to allow any excess acrylic to escape.

4. Light cure bond the male component into the denture (**Fig 17 & 18**); or mix a permanent self-curing resin and place a small amount in the recess of the denture, and around the top area of the metal cap.

5. Insert the denture into position in the oral cavity. Guide the patient into occlusion, maintaining a proper relationship with the opposing arch. Maintain the denture in a passive condition, without compression of the soft tissue, while the acrylic sets. Excessive occlusal pressure during the setting time may cause tissue recoil against the denture base, and could contribute to dislodging and wear of the ZAAG males.

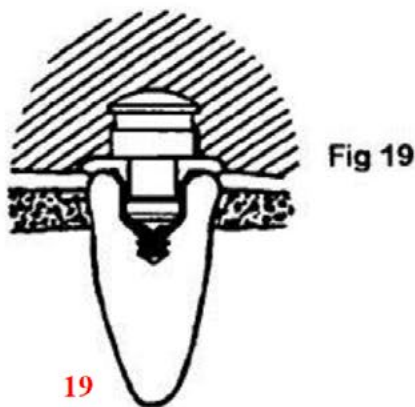

6. Remove the centering sleeve from the Denture Male component. Remove any acrylic over the remaining root surface. There should be no contact between the root and the acrylic saddle or base (**Fig 19**).

7. Instruct the patient in the path of insertion and have the patient insert and remove the prosthesis several times. The snap into retention should be accomplished by finger pressure without the aid of the opposing teeth.

Do not "bite" the prosthesis in to place.

Male Placement by the Laboratory

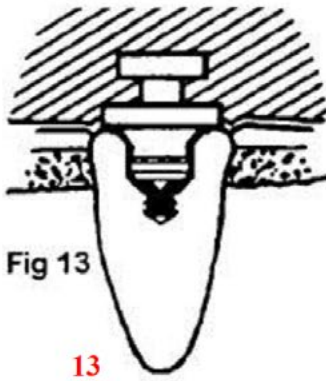

1. Cementation of the metal females and final root contouring is completed in the dental office.

2. Place an Impression Male in the metal female cemented in the oral cavity. Make sure you feel a positive snap, indicating the Impression Male is fully engaged. The male should seat flush on the flange of the metal female component (Fig 13).

3. Make impression exercising caution not to compress the soft tissue. The Impression Males are designed with minimum retention to be drawn in the impression.

Note: a rubber base impression material may easily pick up the Impression Males. If an alginate material is preferred, retention of the Impression Males may be reduced by using a blade to cut off a small section of its retentive band.

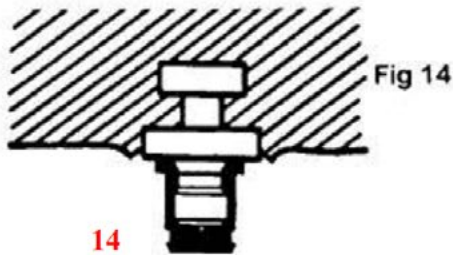

4. Substitute Model Females are placed over the Impression Males in the impression. Make sure the Substitute Female is fully seated (Fig 14).

5. Pour the Master Model. The Substitute Females are now part of the Master Model as an accurate transfer of the position of the female attachments in the oral cavity.

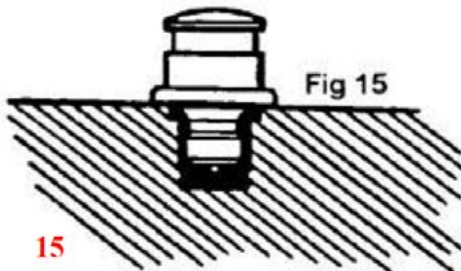

6. Place the male (stainless steel cap, nylon male, and centering sleeve) into each Substitute Female. The centering sleeve eliminates movement of the male during processing (Fig 15).

7. Complete processing of denture base material in the technique of choice.

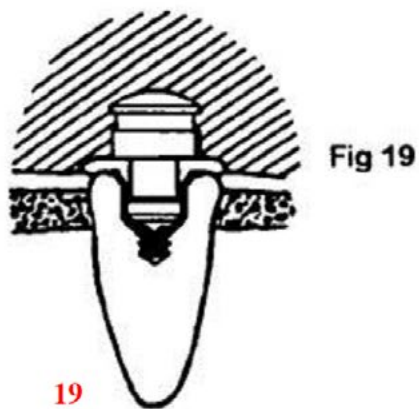

8. Remove the centering sleeves from the males and remove any acrylic over the remaining root surface. There should be no contact between the root and acrylic saddle or base (Fig 19).

Reline and Rebase

1. Using a trephine bur, remove the entire male (metal cap and nylon male) from the overdenture, taking care not to damage the metal housing. All males should be removed for the relining procedure.
2. Trim as much acrylic from the stainless steel cap male as possible using a coarse sandpaper disk. It is not necessary to remove all acrylic from the metal housing for reuse.
3. Place an Impression Male into each cemented female attachment for relining impression pickup.
4. Take a relining impression. Using a Substitute Model Female as an analogue, reposition the denture components into the overdenture following steps in "Male Placement by Laboratory."

NOTE: Extra centering sleeves are provided in all ZAAG attachment Kits to eliminate movement of the Denture Male Component during processing.